



**AERRE ITALIA**  
Family Business, since 1975







IT → **Sensibilità  
e fascino  
nell'arredare**

EN → **SENSITIVITY  
AND CHARM IN FURNISHING**

FR → **DE LA SENSIBILITÉ ET DU  
CHARME DANS L'AMEUBLEMENT**



IT → Genuinamente  
"Made in Italy" e  
realizzati con grande  
attenzione all'ambiente e  
all'utilizzatore,  
i prodotti Aerre Italia  
incarnano una nuova  
sensibilità nell'arredare,  
attenta all'eleganza e al  
fascino degli oggetti come  
al loro contenuto etico.

EN → Genuinely "Made in  
Italy" and created with great  
care to the environment  
and people, Aerre Italia's  
products embody a new  
sensitivity in furnishing,  
attentive to the elegance and  
charm of objects as well as  
the their ethical content.



FR → Véritablement  
"Made in Italy" et faits  
avec beaucoup d'attention  
envers l'environnement et  
l'utilisateur, les produits  
Aerre Italia incarnent une  
nouvelle sensibilité dans  
l'ameublement, attentifs  
à l'élégance et au charme  
des objets autant qu'à leur  
contenu éthique.



IT → Soddisfare  
i sogni  
anticipando  
i bisogni

EN → **SATISFY DREAMS  
ANTICIPATING NEEDS**

FR → **SATISFAIRE LES RÊVES EN  
ANTICIPANT LES BESOINS**

IT → **Aerre Italia crede che innovare significhi soddisfare sogni e anticipare bisogni: non solo inventare nuove soluzioni stilistiche o progettuali per l'interior design e per il benessere, ma anche rispettare l'ambiente, con nuove tecnologie, nuovi processi produttivi, nuovi materiali.**

*EN → Aerre Italia believes that innovating means satisfying dreams and anticipating needs: not only invent new stylistic solutions for the interior design and for the well-being, but also respect to the environment, with new technologies, new production processes, new materials.*

*FR → Pour Aerre Italia, innover signifie réaliser des rêves et anticiper des besoins : ce n'est pas seulement inventer de nouvelles solutions stylistiques ou de projets d'intérieur et pour le bien-être, mais c'est aussi le respect l'environnement, avec de nouvelles technologies, de nouveaux procédés de production, de nouveaux matériaux.*









IT → **Un nuovo  
stile da  
abitare**

EN → **A NEW STYLE  
OF LIVING**

FR → **UN NOUVEAU  
STYLE À VIVRE**

IT → I progetti Aerre Italia nascono dalla libertà creativa di Andrea Arena e dal suo tratto sempre originale, con una passione per gli oggetti che si liberano dalla funzione codificata e prescritta per reinventarsi a nuovi usi: prodotti empatici, amichevoli, godibili. **Oggetti che migliorano la vita delle persone.**

EN → *Aerre Italia projects are born from Andrea Arena creative freedom and its always original trait, with a passion for objects that free themselves from the encoded function to be reinvented to new uses: empathic, friendly products, enjoyable. Objects that improve people's lives.*

FR → *Les projets Aerre Italia sont nés de la liberté créative d'Andrea Arena et de sa vision toujours originale, avec la passion pour les objets qui se démarquent des formes conventionnelles et prescrites pour se réinventer au travers de nouvelles fonctions : des produits empathiques, conviviaux et agréables. Autrement dit, des objets qui améliorent le quotidien.*





**IT → Il Lazy Design si fa spazio. AAA Atelier, è un brand nato nel 2019 da una collaborazione tra Andrea e Alessandro Arena. L'idea di creare qualcosa di strettamente personale che vuole trasmettere uno specifico lifestyle, corredato da uno stile eclettico e originale, con rimandi al passato, in particolare agli anni in cui il design era influenzato dallo stile dell'arte del momento. Architetti, interior designer o semplici appassionati del bello e del gusto di vivere la casa, coloro che si lasciano conquistare dal mondo AAA Atelier costituiscono un pubblico straordinario, fatto di persone estroverse, creative, dinamiche, innovative, a cui piace pensare fuori dagli schemi: persone capaci di modificare il presente e di inventare il futuro. Pensando a queste persone AAA Atelier ha dato vita a nuovi concetti abitativi. attraverso una gamma di prodotti, in stili, modelli e soluzioni tanto varie da consentire una illimitata libertà di progettazione, con soluzioni inedite e imprevedibili, dotate di quelle caratteristiche speciali, estetiche e tecnologiche, che rendono il prodotto e l'ambiente che esso arreda a sua volta speciale: un luogo da vivere e mostrare. A Meldola, in provincia di Forlì è presente l' Atelier, dove sono esposte le varie collezioni, a partire dalla "Capsule collection Dodo", che ha riscosso un grande successo. La crescita del brand è testimoniata dalla presenza poderosa anche su mercati internazionali.**

**EN → Lazy Design gains space. AAA Atelier, is a brand born in 2019. From one collaboration between Andrea and Alessandro Arena. The idea to create something strictly personal that wants to convey a specific lifestyle, accompanied by an eclectic and original style, with references to the past, in particular to the years in which the design was influenced by art style of the moment. Architects, interior designers or simple fans of the beauty and the pleasure of living there home, those who leave conquer from the world. AAA Atelier constitute an extraordinary audience, made up of extroverted people, creative, dynamic, innovative, who like to think outside the box: people capable of modifies the present and of invent the future. Thinking about these people AAA Atelier gave birth to new housing concepts. across a range of products, styles, models and solutions so varied to allow unlimited freedom of design, with new unpredictable solutions, equipped with those special features, aesthetic and techniques, which make the product and the environment turn special: a place to live and show. Meldola, under the province of Forlì, is where the Atelier is from, are exposed many collections, starting with "Dodo collection capsules", which has received a great deal successor. The growth of the brand is testified by the imposing presence even abroad.**

**FR → Le Lazy Design prend sa place. L'Atelier AAA est une marque née en 2019 d'une idée de collaboration entre Andrea et Alessandro Arena. L'idée de créer quelque chose de très personnel qui veut transmettre un style de vie spécifique, lié à un style éclectique et original, avec des retours vers le passé, en particulier vers ces années où le design était sous l'influence du style artistique du moment. Les architectes, designers d'intérieur, ou les simples passionnés du beau et du goût de vivre d'intérieur, ceux qui se laissent conquérir par le monde AAA Atelier font partie d'un public extraordinaire, fait de personnes extraverties, créatives, dynamiques, innovatives, qui aiment penser en dehors des schémas pré-établis : des personnes capables de modifier le présent et d'inventer le futur. C'est en pensant à ces personnes que l'Atelier AAA a donné vie à de nouvelles notions de l'habitat. A travers une gamme de produits de style, des modèles et des solutions très différentes pour permettre une multiple liberté de conception, avec des solutions uniques et imprévisibles, dotées de caractéristiques spéciales, esthétiques, technologiques, qui rendent le produit et l'ambiance qu'elles décorent spéciales elles aussi : un lieu à vivre et à exposer. L'atelier est présent à Meldola, non loin de Forlì, et les différentes collections y sont exposées, à partir de la "Capsule collection Dodo", qui a connu un grand succès. La croissance de la marque se confirme aussi par la présence importante à l'extérieur.**

# Index of contents

## DODO



pag. → 12

## GEMINI



pag. → 32

## YELLOW



pag. → 42

## BYRON



pag. → 72

## NEXI CHIC NEXI YOUNG



pag. → 52  
pag. → 142

## ESATTO



pag. → 92

**BEATTLE**



pag. → 80

**DUMPHY**



pag. → 108

**Q/BIC**



pag. → 128

**VIRGO**



pag. → 164

**SHORE**



pag. → 156

**FLOT**



pag. → 152

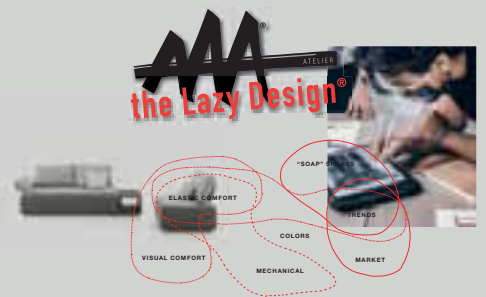

pag. → 2

Dodo

D

o  
d

o









IT → **Dodo: tessuto Bazar 18 / tessuto Bazar 20**  
EN → *Dodo: fabric Bazar 18 / fabric Bazar 20*  
FR → *Dodo: tissu Bazar 18 / tissu Bazar 20*







IT → **Dodo: tessuto Creola 006 / tessuto Ciccio 542**  
EN → *Dodo: fabric Creola 006 / fabric Ciccio 542*  
FR → *Dodo: tissu Creola 006 / tissu Ciccio 542*







IT → **Dodo: tessuto Creola 006 /  
tessuto Ciccio 542 / tessuto Ciccio 447**  
EN → *Dodo: fabric Creola 006 /  
fabric Ciccio 542 / fabric Ciccio 447*  
FR → *Dodo: tissu Creola 006 /  
tissu Ciccio 542 / tissu Ciccio 447*













# Dodo



**Esempi di composizioni**  
**Examples of compositions**  
**Exemples de compositions**

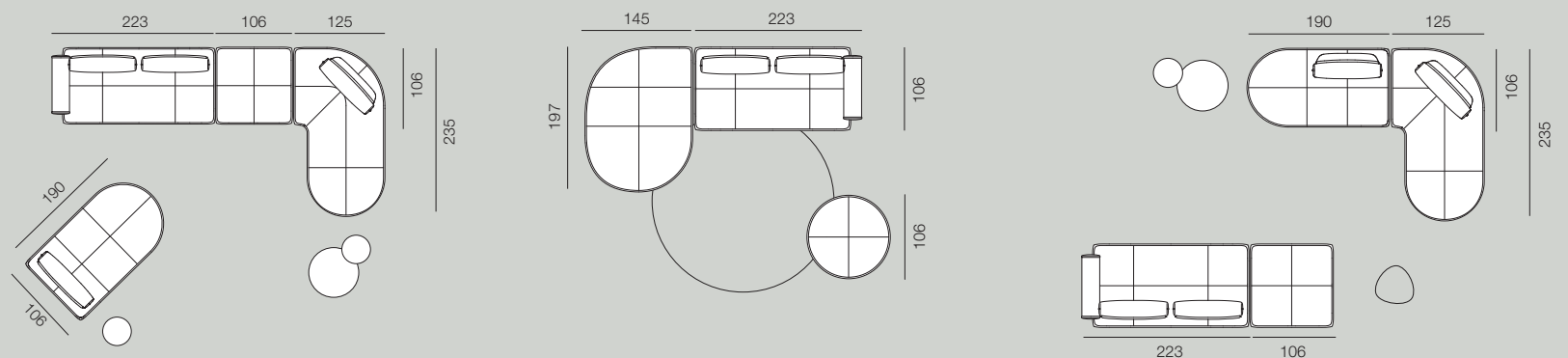

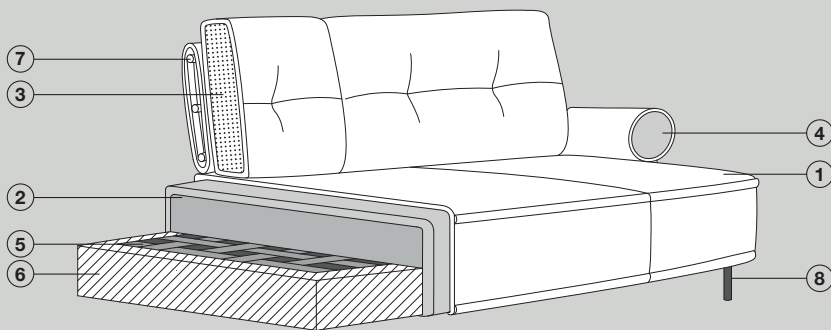
**1 / Rivestimento**

**2 / Imbottitura seduta:** poliuretano espanso HT 35 kg/m<sup>3</sup> ricoperto con resinato accoppiato

**3 / Imbottitura schienale:** fibra di poliestere sfioccato e particelle di poliuretano espanso ricoperto con resinato accoppiato

**4 / Imbottitura bracciolo:** poliuretano espanso ricoperto con resinato accoppiato

**5 / Sistema di molleggio:** cinghie elastiche incrociate

**6 / Struttura portante:** legno massello e multistrato con parti in agglomerato

**7 / Struttura schienale:** metallo

**8 / Piedi in metallo**

**1 / Sofa covering**

**2 / Seat padding:** expanded polyurethane HT 35 kg/m<sup>3</sup> covered with coupled wadding resin

**3 / Backrest padding:** polyester fiber and expanded polyurethane particles covered with coupled wadding resin

**4 / Armrest padding:** expanded polyurethane covered with coupled wadding resin

**5 / Springing:** suspension with elastic crossing belts

**6 / Structure:** solid wood and multilayer frame with parts in plywood and particle board

**7 / Backrest structure:** metal

**8 / Metal feet**

**1 / Revêtement**

**2 / Rembourrage assise:** polyuréthane expansé HT 35 Kg/m<sup>3</sup> recouvert en résiné couplé

**3 / Rembourrage dossier:** fibre de polyester en flocons et particules de polyuréthane expansé recouvert en résiné couplé

**4 / Rembourrage accoudoir:** polyuréthane expansé recouvert en résiné couplé

**5 / Système de suspension:** sangles élastiques entrecroisées

**6 / Structure portante:** bois massif et panneaux agglomérés ou multicouche

**7 / Structure dossier:** métal

**8 / Pieds en métal**

**Finiture metallo****Metal finishes****Finitions métalliques**

306



M312



TITANIO



55

**Divani  
Sofas  
Canapés**

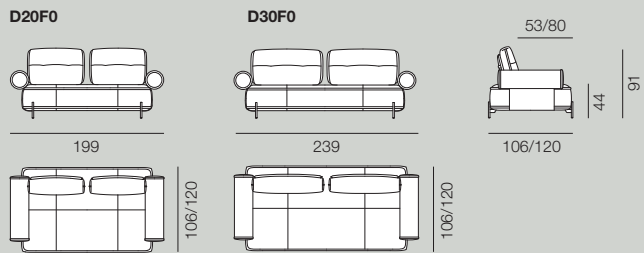

**Basi senza schienali  
Bases without backrests  
Banquettes sans dossiers**

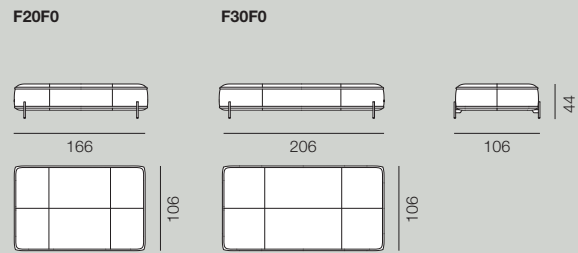

**Elementi centrali  
Central elements  
Banquettes**

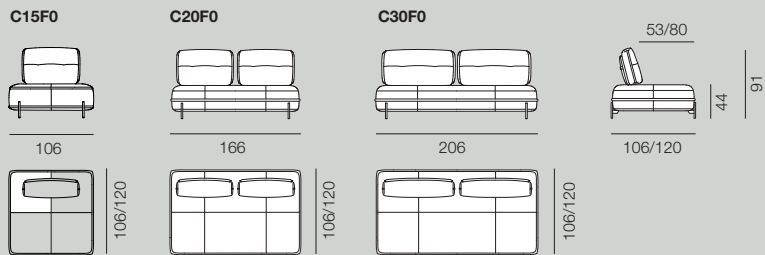

**Pouf  
Pouf  
Poufs**

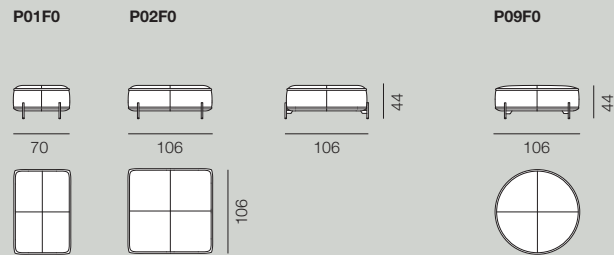

**Elementi terminali  
Terminal elements  
Batards**

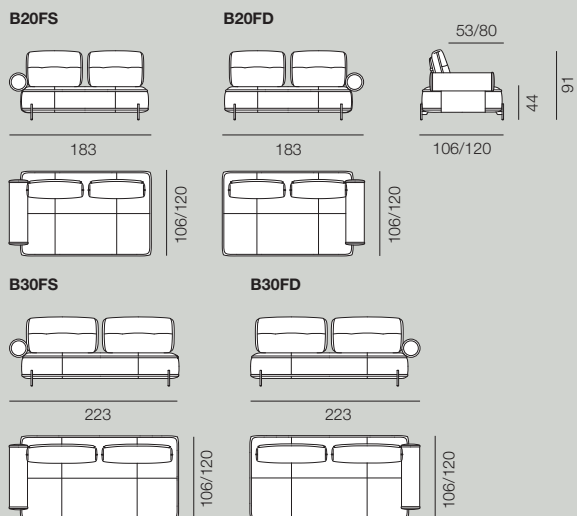

**Schienali liberi  
Removable backrests  
Dossiers amovibles**

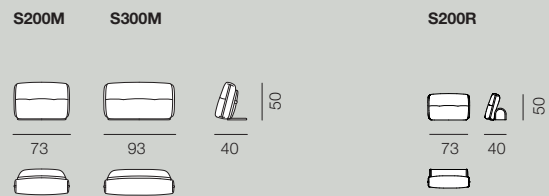

**Poggiatesta  
Headrest  
Appui-tête**

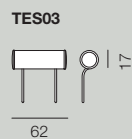

**Bracciolo  
Armrest  
Accoudoir**

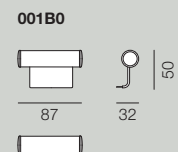



Chaise longues  
Chaise longues  
Chaises longues

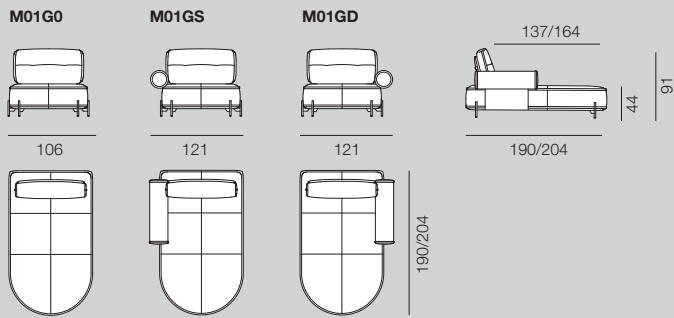

Basi chaise longue senza schienali  
Bases chaise longue without backrests  
Banquettes chaise longue sans dossiers

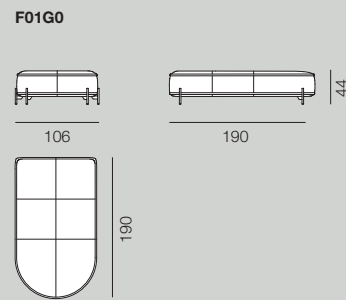

Basi angolari  
Corner elements  
Banquettes d'angle



Gemini

G  
e  
m  
i  
n  
i





IT → **Gemini: tessuto Morris 10 / tessuto Ray 10**  
EN → *Gemini: fabric Morris 10 / fabric Ray 10*  
FR → *Gemini: tissu Morris 10 / tissu Ray 10*







# Gemini



**Esempi di composizioni**  
**Examples of compositions**  
**Exemples de compositions**

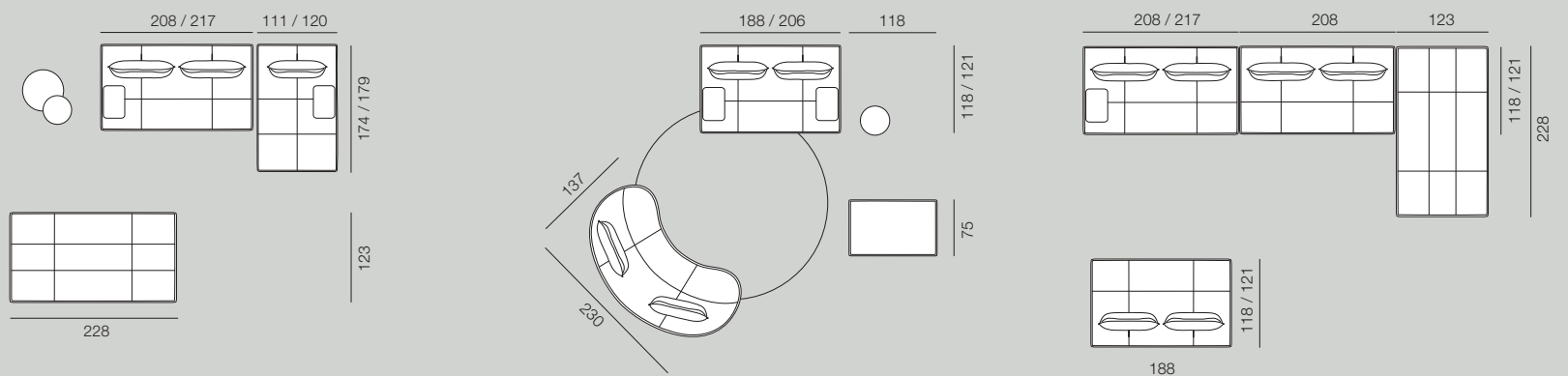



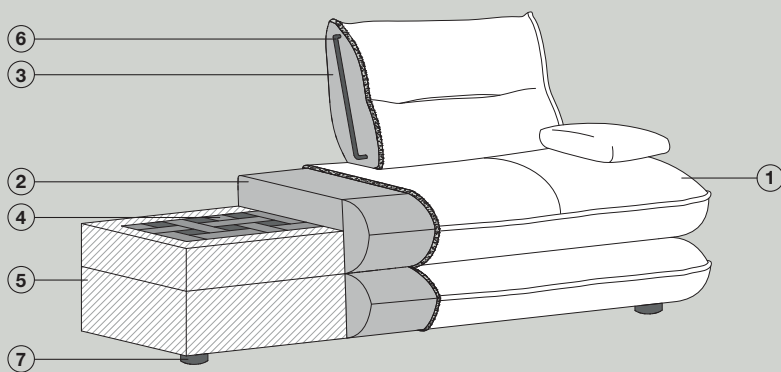

**1 / Rivestimento**  
**2 / Imbottitura seduta:** poliuretano espanso HT 35 kg/m<sup>3</sup> ricoperto con resinato accoppiato  
**3 / Imbottitura schienale:** poliuretano espanso a densità differenziata  
**4 / Sistema di molleggio:** cinghie elastiche incrociate  
**5 / Struttura portante:** legno massello e multistrato con parti in agglomerato  
**6 / Struttura schienale:** scheletro in metallo  
**7 / Piedi in ABS** antiscivolo

**1 / Sofa covering**  
**2 / Seat padding:** expanded polyurethane HT 35 kg/m<sup>3</sup> covered with coupled wadding resin  
**3 / Backrest padding:** expanded polyurethane in variable density  
**4 / Springing:** suspension with elastic crossing belts  
**5 / Structure:** solid wood and multilayer frame with parts in plywood and particle board  
**6 / Backrest structure:** metal frame  
**7 / Antislip ABS feet**

**1 / Revêtement**  
**2 / Rembourrage assise:** polyuréthane expansé HT 35 Kg/m<sup>3</sup> recouvert en résiné couplé  
**3 / Rembourrage dossier:** polyuréthane expansé multi-densité  
**4 / Système de suspension:** sangles élastiques entrecroisées  
**5 / Structure portante:** bois massif et panneaux agglomérés ou multicouche  
**6 / Structure dossier:** support en métal  
**7 / Pieds ABS** antidérapant

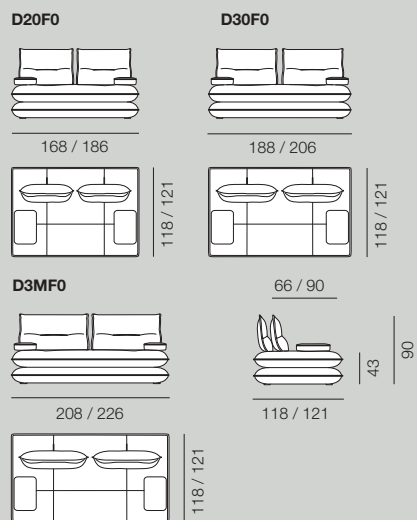
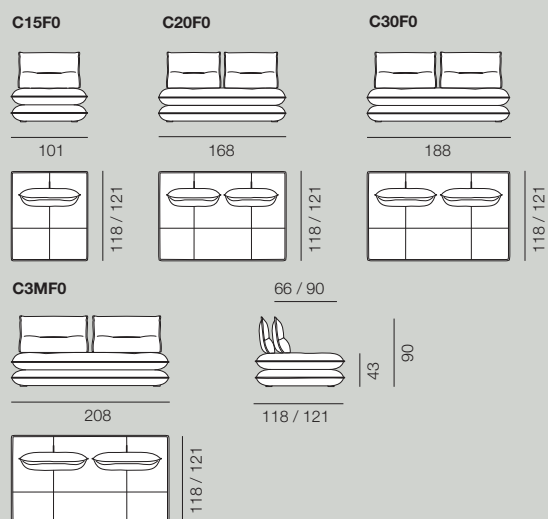
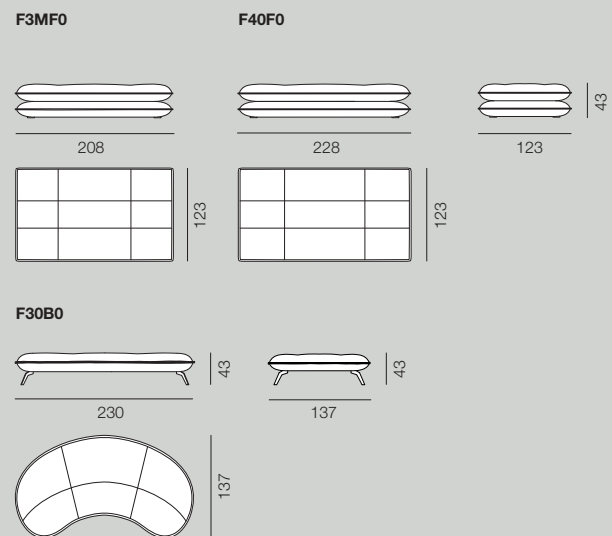
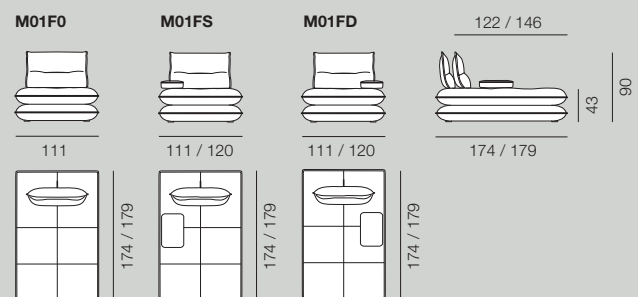
**Divani  
Sofas  
Canapés**

**Elementi centrali  
Central elements  
Banquettes**

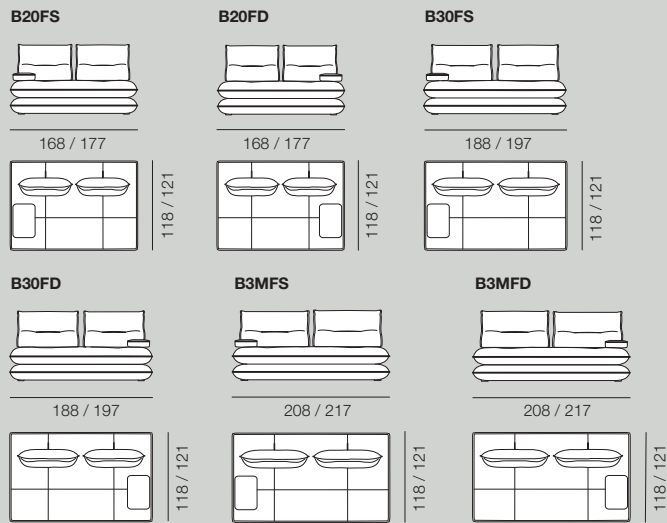
**Basi senza schienali  
Bases without backrests  
Banquettes sans dossiers**

**Chaise longues  
Chaise longues  
Chaises longues**

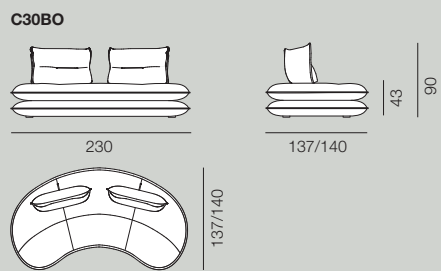
**Elementi terminali**  
Terminal elements  
Batards



**Centrale 3 posti curvo**  
Central element 3 seaters curve  
Banquette courbée



**Pouf**  
Pouf  
Poufs

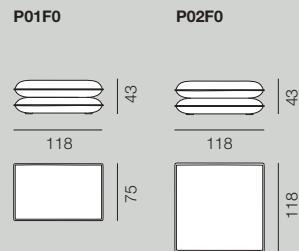

**Schienali liberi**  
Removable backrests  
Dossiers amovibles

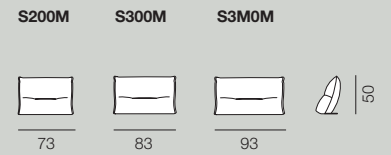

# Yellow

Y

e

ll

o

w







IT → **Yellow: pelle Seta Alga 9050 / tessuto Morris 06 / tessuto Ray 06**  
EN → *Yellow: leather Seta Alga 9050 / fabric Morris 06 / fabric Ray 06*  
FR → *Yellow: cuir Seta Alga 9050 / tissu Morris 06 / tissu Ray 06*









IT → **Yellow: pelle Seta Alga 9050 / tessuto Morris 06 / tessuto Ray 06**  
EN → *Yellow: leather Seta Alga 9050 / fabric Morris 06 / fabric Ray 06*  
FR → *Yellow: cuir Seta Alga 9050 / tissu Morris 06 / tissu Ray 06*



# Yellow



---

**Esempi di composizioni**  
**Examples of compositions**  
**Exemples de compositions**

---

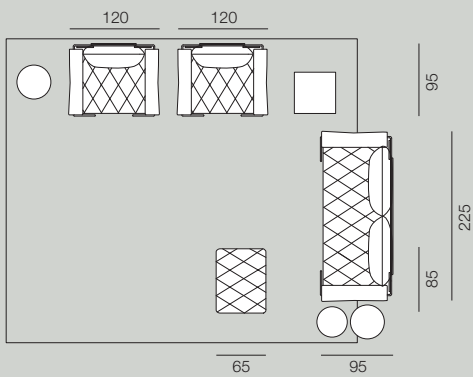

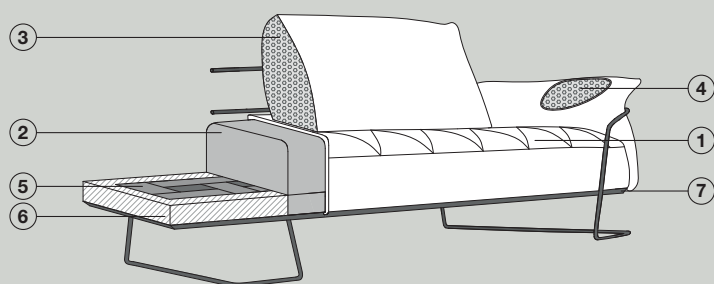

1 / Rivestimento  
 2 / Imbottitura seduta: poliuretano espanso HT 35 kg/m<sup>3</sup> ricoperto con resinato accoppiato  
 3 / Imbottitura schienale: piuma d'oca  
 4 / Imbottitura bracciolo: piuma d'oca  
 5 / Sistema di molleggio: cinghie elastiche incrociate  
 6 / Struttura portante: legno massello e multistrato con parti in agglomerato  
 7 / Struttura metallica

1 / Sofa covering  
 2 / Seat padding: expanded polyurethane HT 35 kg/m<sup>3</sup> covered with coupled wadding resin  
 3 / Backrest padding: feather  
 4 / Armrest padding: feather  
 5 / Springing: suspension with elastic crossing belts  
 6 / Structure: solid wood and multilayer frame with parts in plywood and particle board  
 7 / Metal structure

1 / Revêtement  
 2 / Rembourrage assise: polyuréthane expansé HT 35 Kg/m<sup>3</sup> recouvert en résiné couplé  
 3 / Rembourrage dossier: plume d'oie  
 4 / Rembourrage accoudoir: plume d'oie  
 5 / Système de suspension: sangles élastiques entrecroisées  
 6 / Structure portante: bois massif et panneaux agglomérés ou multicouche  
 7 / Structure en métal

**Finiture metallo**  
**Metal finishes**  
**Finitions métalliques**

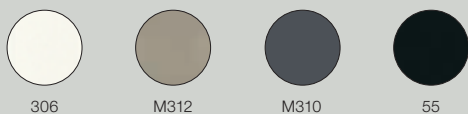

**Poltrona**  
**Armchair**  
**Fauteuil**

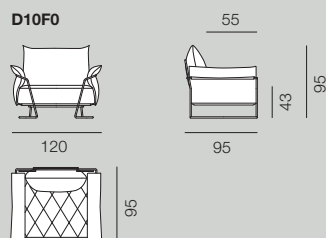

**Pouf**  
**Pouf**  
**Pouf**

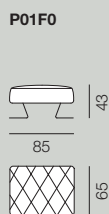

**Poggiarene**  
**Lumbar support**  
**Cale rein**



**Divani**  
**Sofas**  
**Canapés**

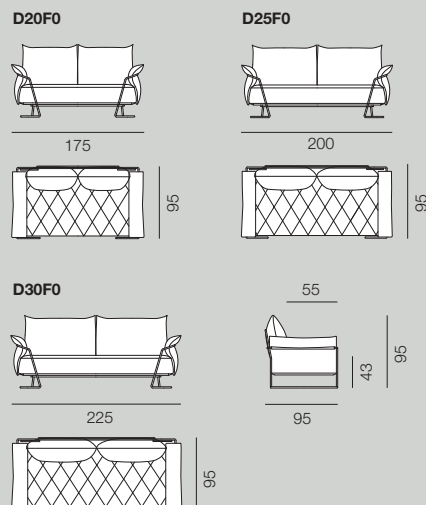

**Poggiatesta**  
**Headrest**  
**Appuie-tête**



# Nexi Chic

N  
e  
xi  
C  
h  
i  
c









IT → **Nexi Chic: tessuto Frisé 805 / tessuto Leida 48**  
EN → *Nexi Chic: fabric Frisé 805 / fabric Leida 48*  
FR → *Nexi Chic: tissu Frisé 805 / tissu Leida 48*







IT → **Nexi Chic: tessuto Frisé 805 / tessuto Leida 48**  
EN → *Nexi Chic: fabric Frisé 805 / fabric Leida 48*  
FR → *Nexi Chic: tissu Frisé 805 / tissu Leida 48*







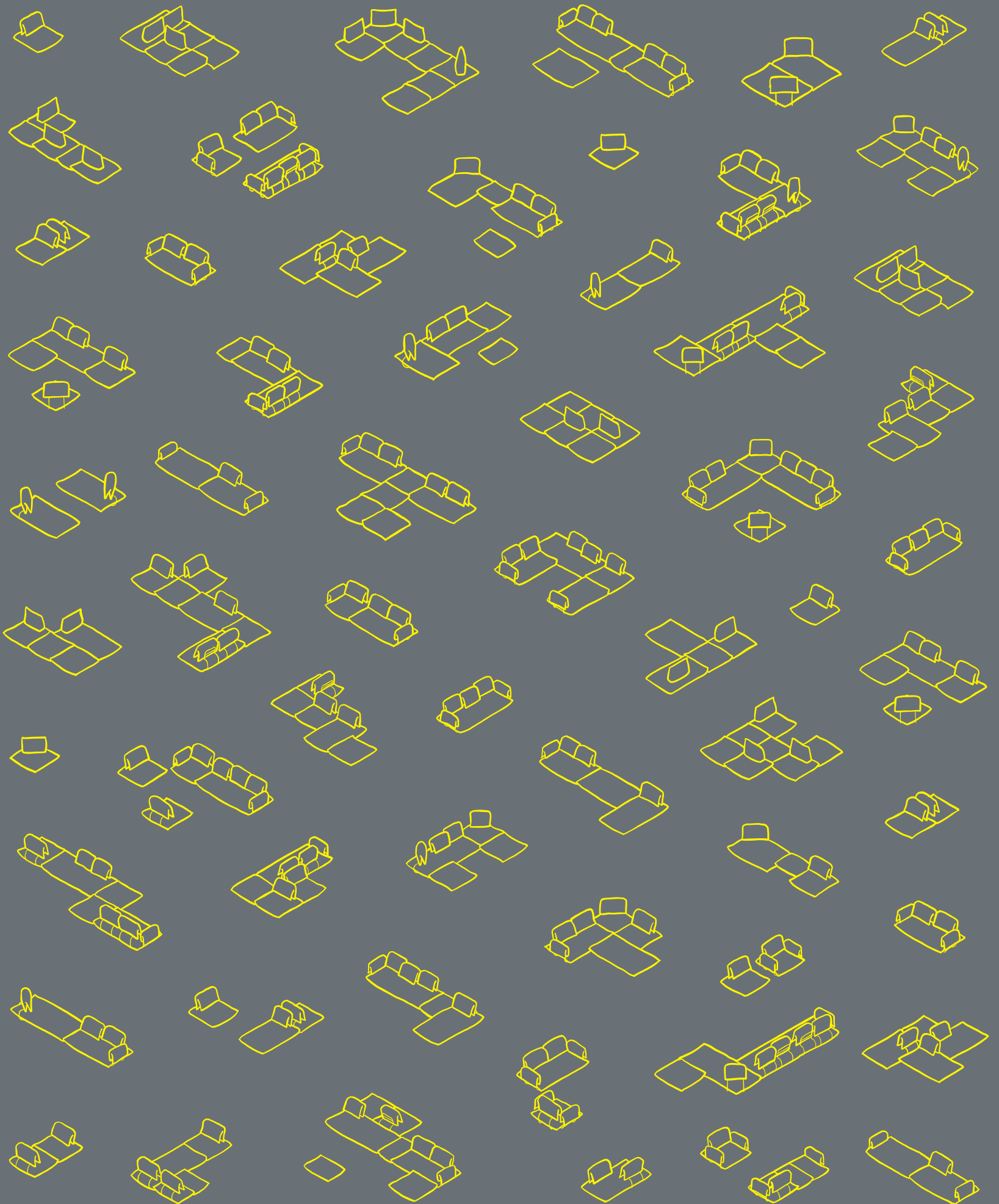





**IT → Nexi Chic: tessuto Cool 801 /  
tessuto Frisé 800 / tessuto Cool 815**

**EN → Nexi Chic: fabric Cool 801 /  
fabric Frisé 800 / fabric Cool 815**

**FR → Nexi Chic: tissu Cool 801 /  
tissu Frisé 800 / tissu Cool 815**





IT → **Nexi Young (Sinistra): tessuto Cool 805**

EN → *Nexi Young (Left): fabric Cool 805*

FR → *Nexi Young (Gauche): tissu Cool 805*

IT → **Nexi Chic (Destra): tessuto Cool 801 /  
tessuto Frisé 800 / tessuto Cool 815**

EN → *Nexi Chic (Right): fabric Cool 801 /  
fabric Frisé 800 / fabric Cool 815*

FR → *Nexi Chic (Droit): tissu Cool 801 /  
tissu Frisé 800 / tissu Cool 815*



# Nexi Chic



**Esempi di composizioni**  
**Examples of compositions**  
**Exemples de compositions**

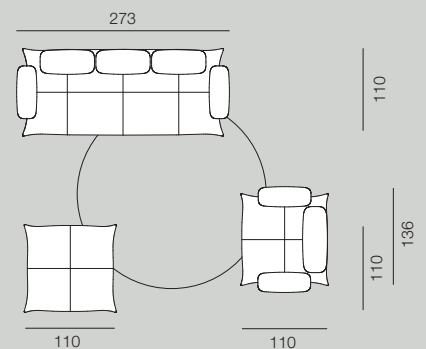
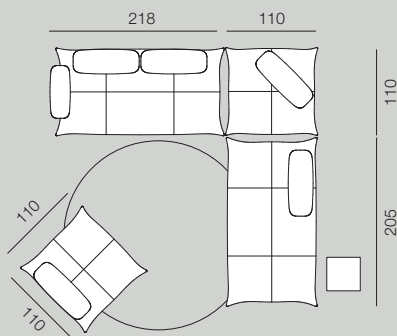
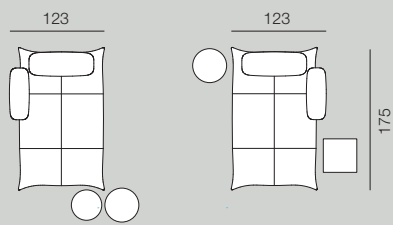

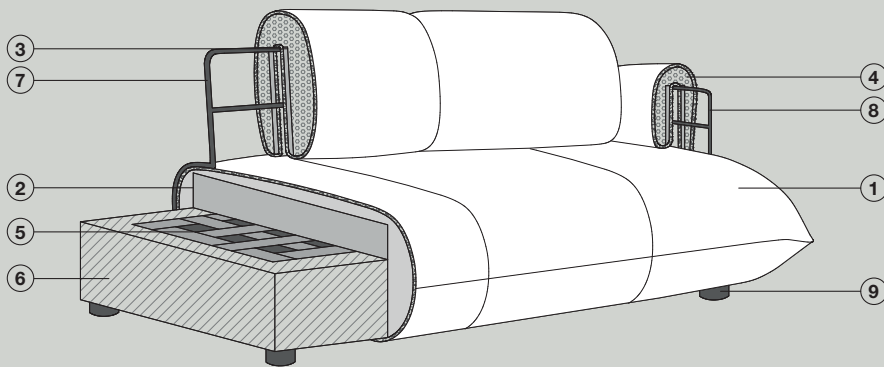

1 / Rivestimento  
 2 / Imbottitura seduta: poliuretano espanso HT 35 kg/m<sup>3</sup> ricoperto con resinato accoppiato  
 3 / Imbottitura schienale: poliuretano espanso e piuma d'oca  
 4 / Imbottitura bracciolo: poliuretano espanso e piuma d'oca  
 5 / Sistema di molleggio: cinghie elastiche incrociate  
 6 / Struttura portante: legno massello e multistrato con parti in agglomerato  
 7 / Struttura schienale: supporto in metallo  
 8 / Struttura bracciolo: supporto in metallo  
 9 / Piedi in ABS antiscivolo

1 / Sofa covering  
 2 / Seat padding: expanded polyurethane HT 35 kg/m<sup>3</sup> covered with coupled wadding resin  
 3 / Backrest padding: expanded polyurethane and feather  
 4 / Armrest padding: expanded polyurethane and feather  
 5 / Springing: suspension with elastic crossing belts  
 6 / Structure: solid wood and multilayer frame with parts in plywood and particle board  
 7 / Backrest structure: metal support  
 8 / Armrest structure: metal support  
 9 / Antislip ABS feet

1 / Revêtement  
 2 / Rembourrage assise: polyuréthane expansé HT 35 Kg/m<sup>3</sup> recouvert en résiné couplé  
 3 / Rembourrage dossier: polyuréthane expansé et plume d'oie  
 4 / Rembourrage accoudoir: polyuréthane expansé et plume d'oie  
 5 / Système de suspension: sangles élastiques entrecroisées  
 6 / Structure portante: bois massif et panneaux agglomérés ou multicouche  
 7 / Structure dossier: support en métal  
 8 / Structure accoudoir: support en métal  
 9 / Pieds ABS antidérapant

**Finiture metallo**  
**Metal finishes**  
**Finitions métalliques**



306



M312



55

**Divani  
Sofas  
Canapés**

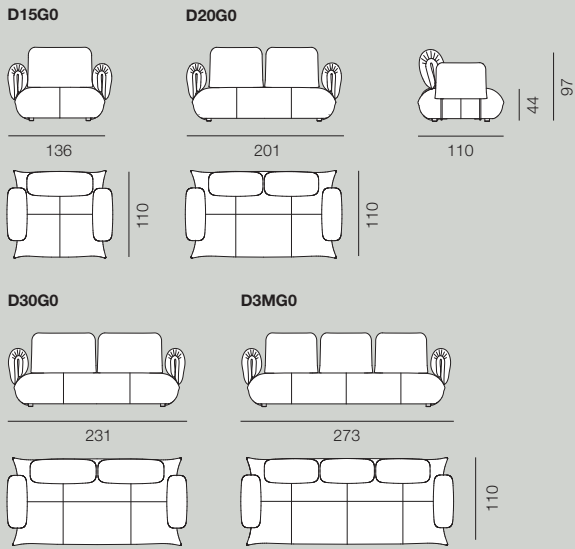

**Basi senza schienali  
Bases without backrests  
Banquettes sans dossiers**

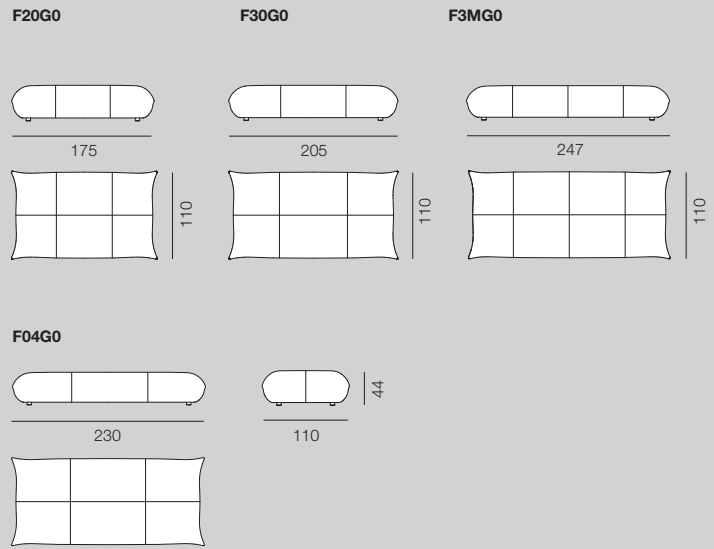

**Elementi centrali  
Central elements  
Banquettes**

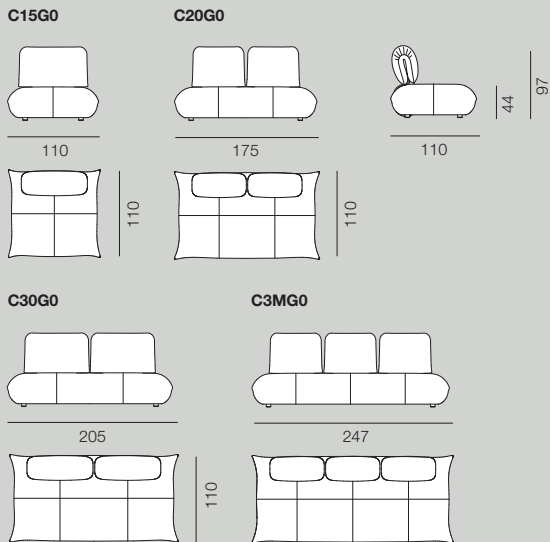

**Pouf  
Pouf  
Poufs**

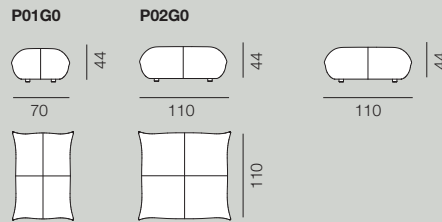

**Schienali  
Backrests  
Dossiers**

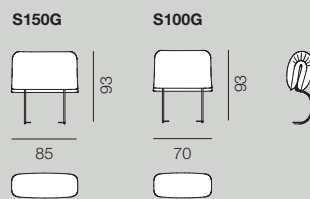

**Bracciolo  
Armrest  
Accoudoir**

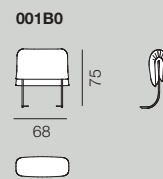



**Elementi terminali**  
Terminal elements  
Batards

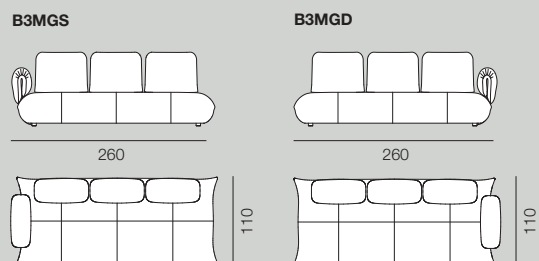
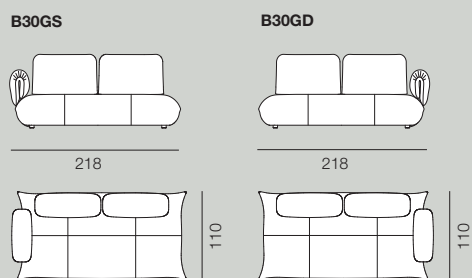
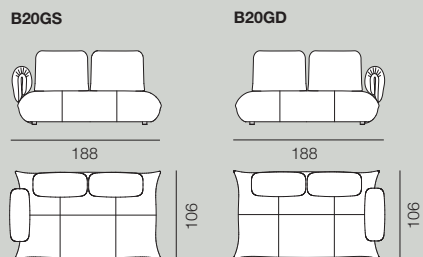

**Chaise longues**  
Chaise longues  
Chaises longues

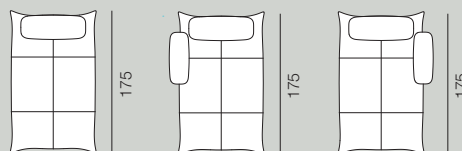
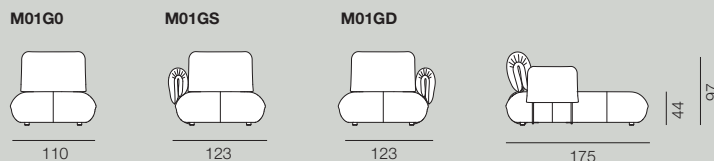

**Angolari**  
Corner elements  
Eléments d'angle

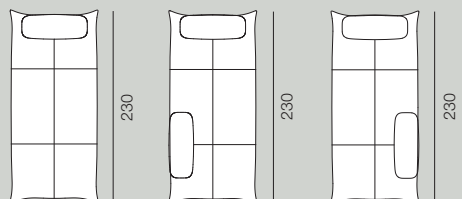
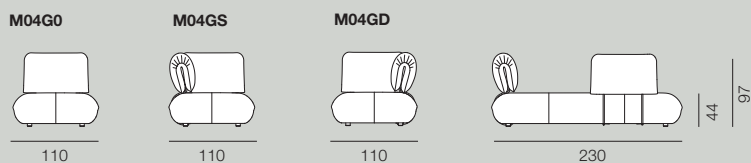

# Byron

# Byron





IT → **Byron: tessuto Fervor 07 / tessuto Bazar 17**  
EN → *Byron: fabric Fervor 07 / fabric Bazar 17*  
FR → *Byron: tissu Fervor 07 / tissu Bazar 17*







IT → **Byron: tessuto Fervor 07 / tessuto Bazar 17**  
EN → *Byron: fabric Fervor 07 / fabric Bazar 17*  
FR → *Byron: tissu Fervor 07 / tissu Bazar 17*



# Byron



**Esempi di composizioni**  
**Examples of compositions**  
**Exemples de compositions**

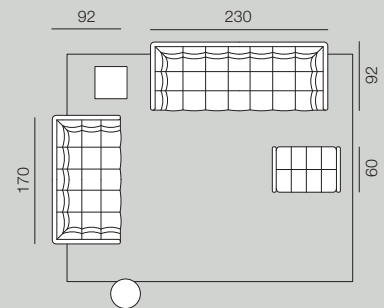
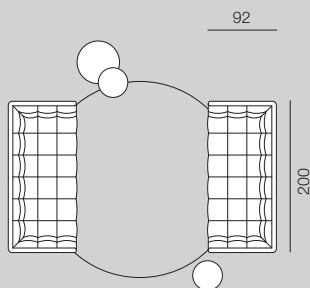
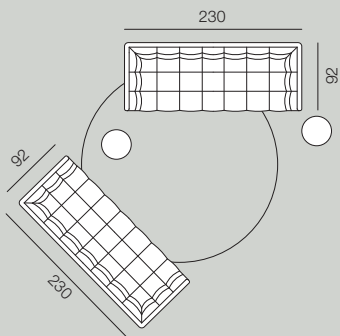



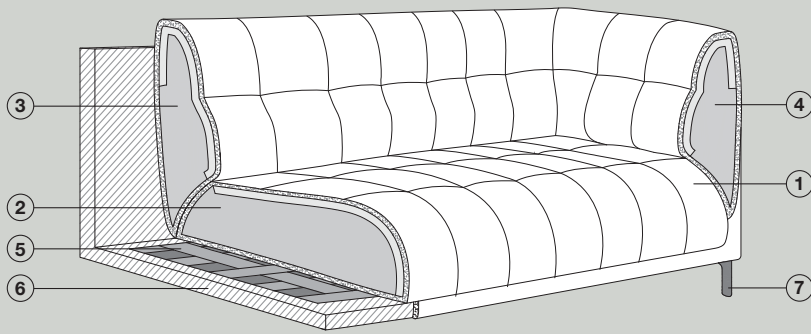

1 / Rivestimento  
 2 / Imbottitura seduta: poliuretano espanso 30 kg/m<sup>3</sup> ricoperto con resinato accoppiato  
 3 / Imbottitura schienale: poliuretano espanso ricoperto con resinato accoppiato  
 4 / Imbottitura bracciolo: poliuretano espanso ricoperto con resinato accoppiato  
 5 / Sistema di molleggio: cinghie elastiche incrociate  
 6 / Struttura portante: legno massello e multistrato con parti in agglomerato  
 7 / Piedini in metallo

1 / Sofa covering  
 2 / Seat padding: expanded polyurethane 30 kg/m<sup>3</sup> covered with coupled wadding resin  
 3 / Backrest padding: expanded polyurethane covered with coupled wadding resin  
 4 / Armrest padding: expanded polyurethane covered with coupled wadding resin  
 5 / Springing: suspension with elastic crossing belts  
 6 / Structure: solid wood and multilayer frame with parts in plywood and particle board  
 7 / Metal feet

1 / Revêtement  
 2 / Rembourrage assise: polyuréthane expansé 30 Kg/m<sup>3</sup> recouvert en résiné couplé  
 3 / Rembourrage dossier: polyuréthane expansé recouvert en résiné couplé  
 4 / Rembourrage accoudoir: polyuréthane expansé recouvert en résiné couplé  
 5 / Système de suspension: sangles élastiques entrecroisées  
 6 / Structure portante: bois massif et panneaux agglomérés ou multicouche  
 7 / Pieds en métal

**Finiture metallo**  
**Metal finishes**  
**Finitions métalliques**



**Divani**  
**Sofas**  
**Canapés**

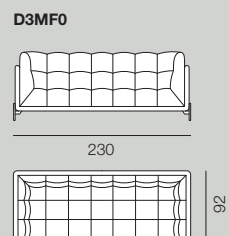
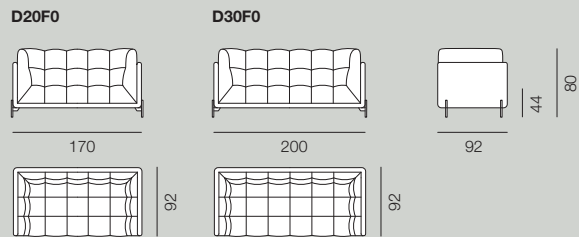

**Pouf**  
**Pouf**  
**Pouf**

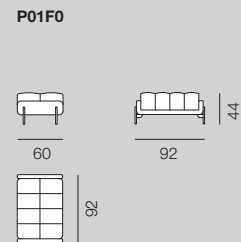

**Poggiatesta**  
**Headrest**  
**Appui-tête**

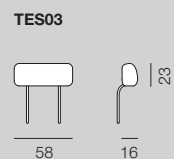

# Beattle

B  
e  
a  
tt  
l  
e



IT → **Beattle: tessuto Brezza 20 / tessuto Amsterdam 66**  
EN → *Beattle: fabric Brezza 20 / fabric Amsterdam 66*  
FR → *Beattle: tissu Brezza 20 / tissu Amsterdam 66*

IT → **Beattle: tessuto Brezza 122 / tessuto Amsterdam 03**

EN → *Beattle: fabric Brezza 122 / fabric Amsterdam 03*

FR → *Beattle: tissu Brezza 122 / tissu Amsterdam 03*







IT → **Beattle: tessuto Blend 62 / tessuto Sinfonia 06**

EN → *Beattle: fabric Blend 62 / fabric Sinfonia 06*

FR → *Beattle: tissu Blend 62 / tissu Sinfonia 06*



IT → **Beattle: tessuto Frisè 807 and 805 / tessuto Amsterdam 08 and 48**  
EN → *Beattle: fabric Frisè 807 e 805 / fabric Amsterdam 08 e 48*  
FR → *Beattle: tissu Frisè 807 e 805 / tissu Amsterdam 08 e 48*









IT → **Beattle: tessuto Frisè 807 and 805 / tessuto Amsterdam 08 and 48**  
EN → *Beattle: fabric Frisè 807 e 805 / fabric Amsterdam 08 e 48*  
FR → *Beattle: tissu Frisè 807 e 805 / tissu Amsterdam 08 e 48*



# Beattle

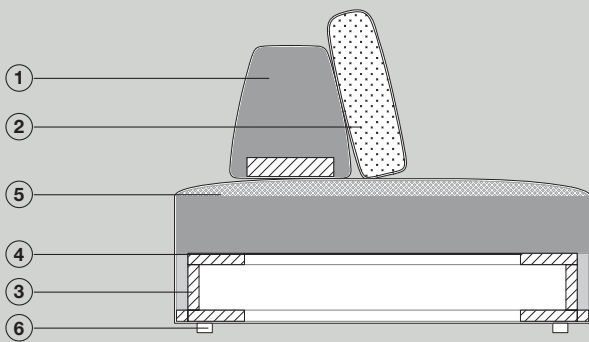

1 / Poliuretano espanso a densità variabile  
 2 / Imbottitura in piuma e fibra poliestere cava avvolta in tela di cotone  
 3 / Legno massello e multistrato con parti in agglomerato  
 4 / Cinghie elastiche incrociate  
 5 / Visco elastico  
 6 / ABS antiscivolo

1 / Expanded polyurethane in variable density  
 2 / Padding in feather and polyester fibre wrapped up in cotton canvas  
 3 / Solid wood and multilayer frame with parts in plywood and particle board  
 4 / Elastic crossing belts  
 5 / Viscoelastic foam  
 6 / Anti-slip ABS

1 / Polyuréthane expansé à densité variable  
 2 / Rembourrage en plumes et fibres de polyester creux enveloppé dans un tissu en coton  
 3 / Bois massif contreplaqué et multicouche avec panneaux agglomérés  
 4 / Sangles élastiques entrecroisées  
 5 / Visco élastique  
 6 / Pieds ABS antidérapants

## Esempi di composizioni Examples of compositions Exemples de compositions

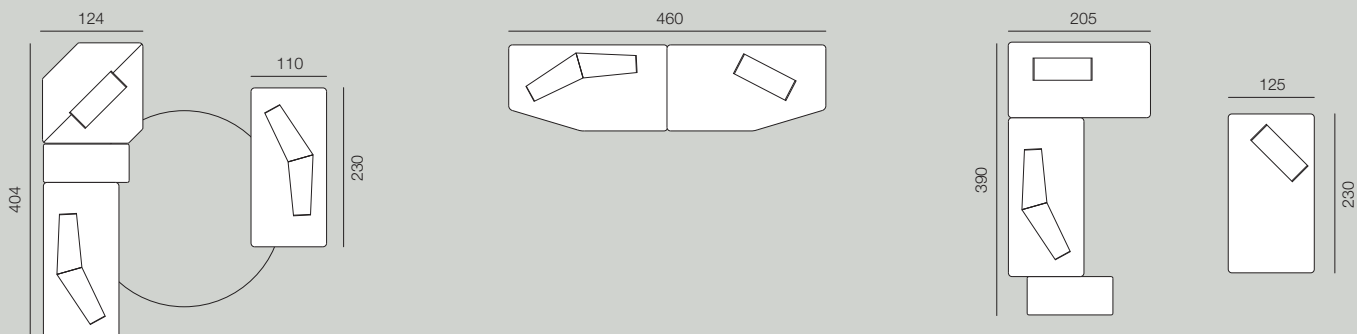

Pouf  
Pouf  
Poufs

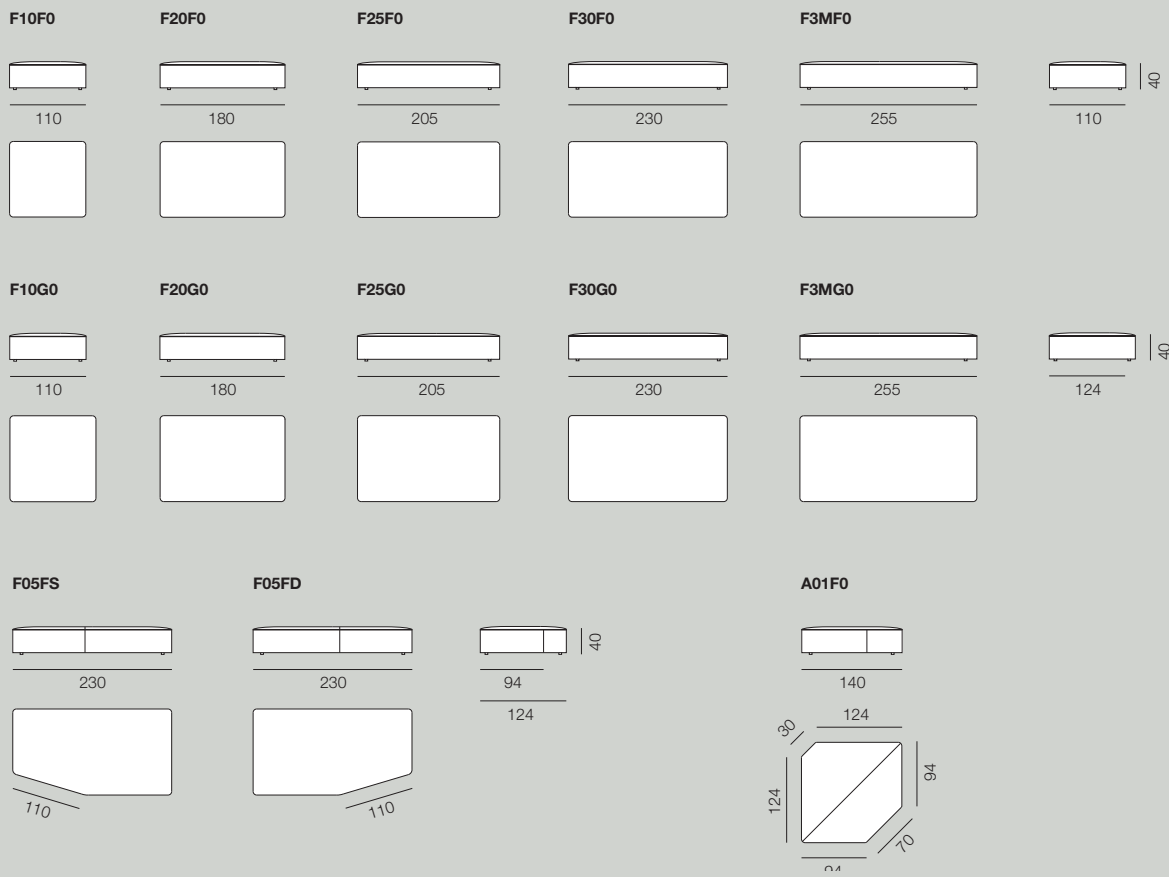

Pouf  
Pouf  
Poufs

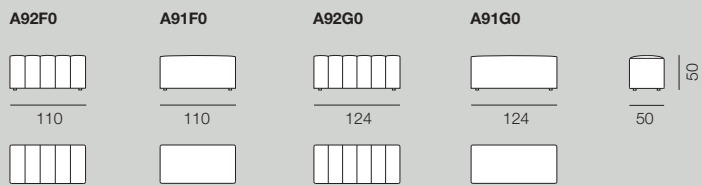

Schienale  
Backrest  
Dossiers

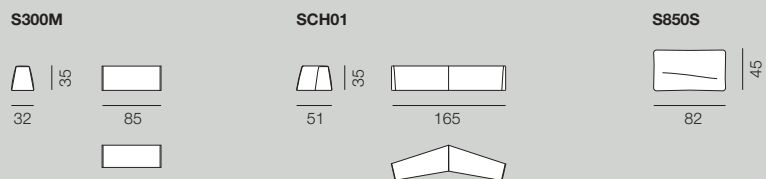

Esatto

E

S

a

tt

O











IT → **Esatto: tessuto Barbat 02**

EN → *Esatto: fabric Barbat 02*

FR → *Esatto: tissu Barbat 02*



IT → **Esatto: pelle Emotion 1504 Taupe**  
EN → *Esatto: leather Emotion 1504 Taupe*  
FR → *Esatto: cuir Emotion 1504 Taupe*













IT → **Esatto: tessuto Amadeus 01**

EN → *Esatto: fabric Amadeus 01*

FR → *Esatto: tissu Amadeus 01*



# Esatto



---

**Esempi di composizioni**  
**Examples of compositions**  
**Exemples de compositions**

---

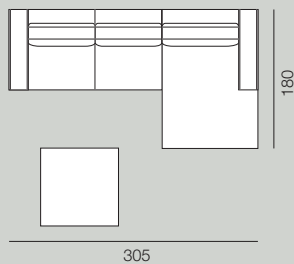
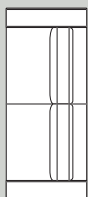
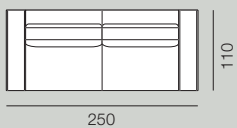

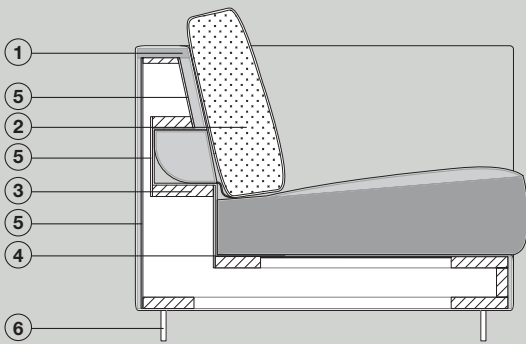

**1** / Poliuretano espanso a densità variabile  
**2** / Imbottitura in piuma e fibra poliestere cava avvolta in tela di cotone  
**3** / Legno massello e multistrato con parti in agglomerato  
**4** / Cinghie elastiche incrociate  
**5** / Pannello di masonite  
**6** / Metallo verniciato

**1** / Expanded polyurethane in variable density  
**2** / Padding in feather and polyester fibre wrapped up in cotton canvas  
**3** / Solid wood and multilayer frame with parts in plywood and particle board  
**4** / Elastic crossing belts  
**5** / Masonite panel  
**6** / Painted metal

**1** / Polyuréthane expansé à densité variable  
**2** / Rembourrage en plumes et fibres de polyester enveloppées dans une toile en coton  
**3** / Cadre en bois massif et multicouches avec pièces en contreplaqué et panneaux de particules  
**4** / Sangles élastiques entrecroisées  
**5** / Panneau de masonite  
**6** / Métal vernis

**Finiture metallo**  
**Metal finishes**  
**Finitions métalliques**



306



55



M310

---

**Divani  
Sofas  
Canapés**

---

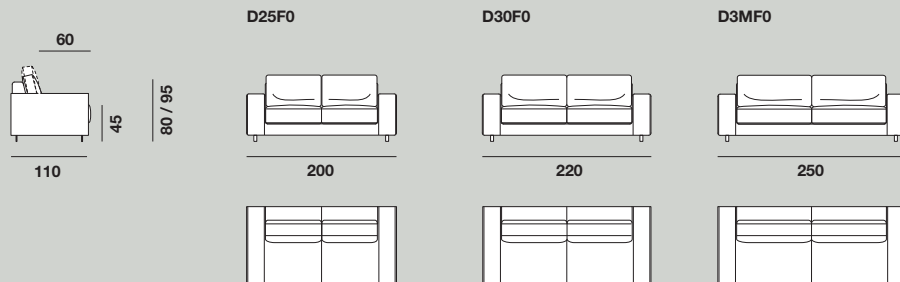



---

**Elementi centrali  
Central elements  
Chaufeuse et banquette**

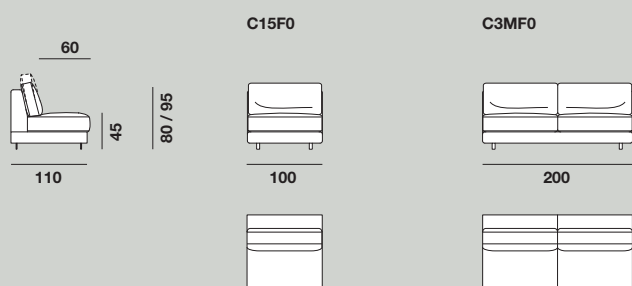
---

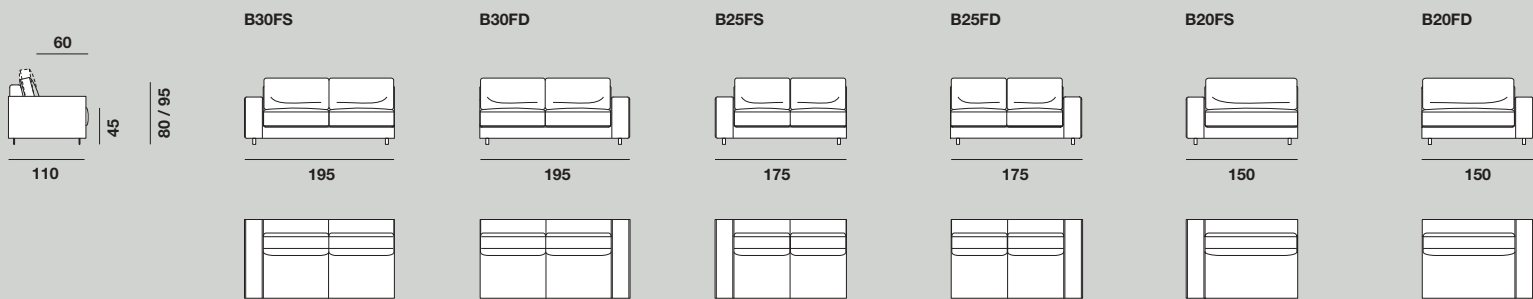

**Elementi terminali**  
**Terminal elements with one armrest**  
**Batards**



**Chaise longue**  
**Chaise longue**  
**Chaises longues**

**Pouf**  
**Pouf**  
**Poufs**

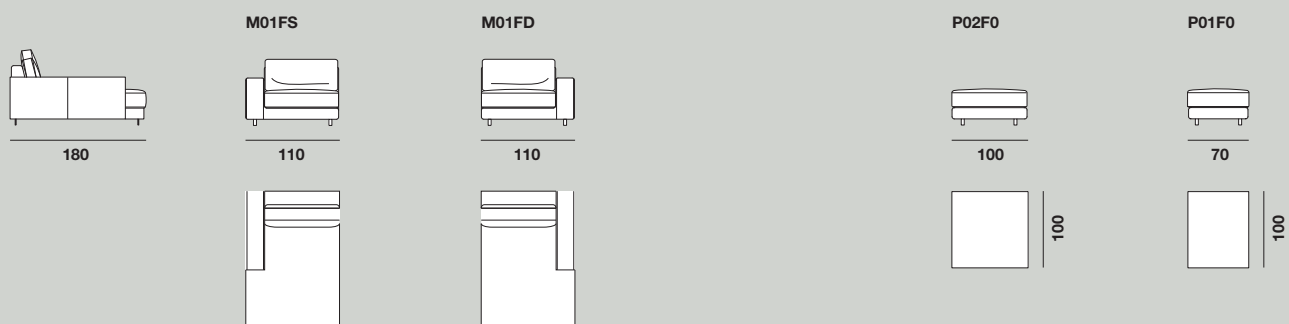

# Dumphy

design TOSHIYUKI YOSHINO

D

u

m

ph

y









IT → **Dumphy: tessuto Brezza 119**  
EN → *Dumphy: fabric Brezza 119*  
FR → *Dumphy: tissu Brezza 119*











IT → **Dumphy: tessuto Brezza 119 / pelle Seta 9025**  
EN → *Dumphy: fabric Brezza 119 / leather Seta 9025*  
FR → *Dumphy: tissu Brezza 119 / cuir Seta 9025*







IT → **Dumphy: tessuto Brezza 102**  
EN → *Dumphy: fabric Brezza 102*  
FR → *Dumphy: tissu Brezza 102*



IT → **Dumphy: tessuto Brezza 119**

EN → *Dumphy: fabric Brezza 119*

FR → *Dumphy: tissu Brezza 119*



IT → **Dumphy: tessuto Brezza 102**  
EN → *Dumphy: fabric Brezza 102*  
FR → *Dumphy: tissu Brezza 102*





IT → **Dumphy: tessuto Brezza 102**  
EN → *Dumphy: fabric Brezza 102*  
FR → *Dumphy: tissu Brezza 102*



# Dumphy



Esempi di composizioni  
Examples of compositions  
Exemples de compositions

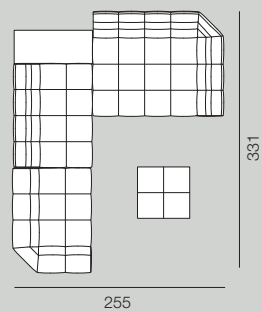
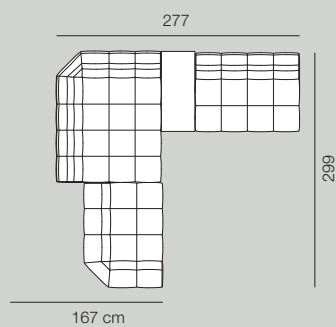
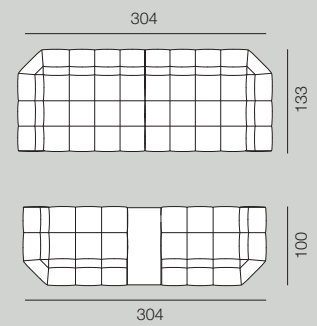
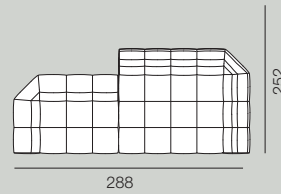
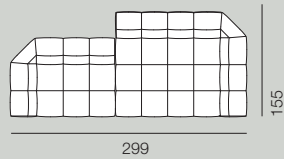
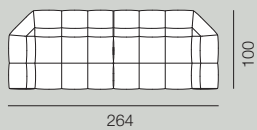

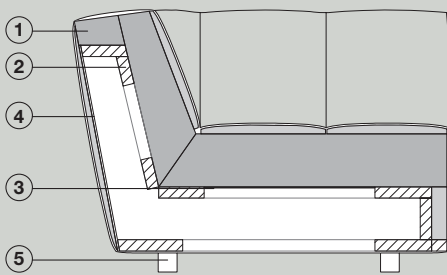

1 / Poliuretano espanso a densità variabile  
 2 / Legno massello e multistrato con parti in agglomerato  
 3 / Cinghie elastiche incrociate  
 4 / Pannello di masonite  
 5 / ABS antiscivolo

1 / Expanded polyurethane in variable density  
 2 / Solid wood and multilayer frame with parts in plywood and particle board  
 3 / Elastic crossing belts  
 4 / Masonite panel  
 5 / Anti-slip ABS

1 / Polyuréthane expansé à densité variable  
 2 / Cadre en bois massif et multicouches avec pièces en contreplaqué et panneaux de particules  
 3 / Sangles élastiques entrecroisées  
 4 / Panneau de masonite  
 5 / Pieds ABS antidérapants

**Finiture legno**  
**Veneer finishes**  
**Finitions bois**



Grigio

Dumphy Lounge

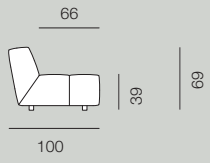

**C10F0**



101

**C15F0**

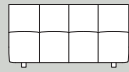

132

**B10FD**

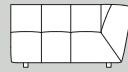

132

**B10FS**

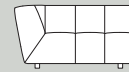

132

**C10G0**



101

**C15G0**

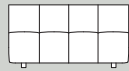

132

**B15GD**

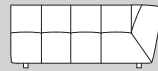

167

**B15GS**

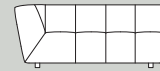

167

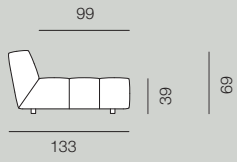

**M10F0**

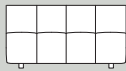

132

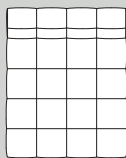
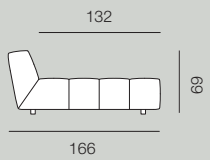



Dumphy Plus

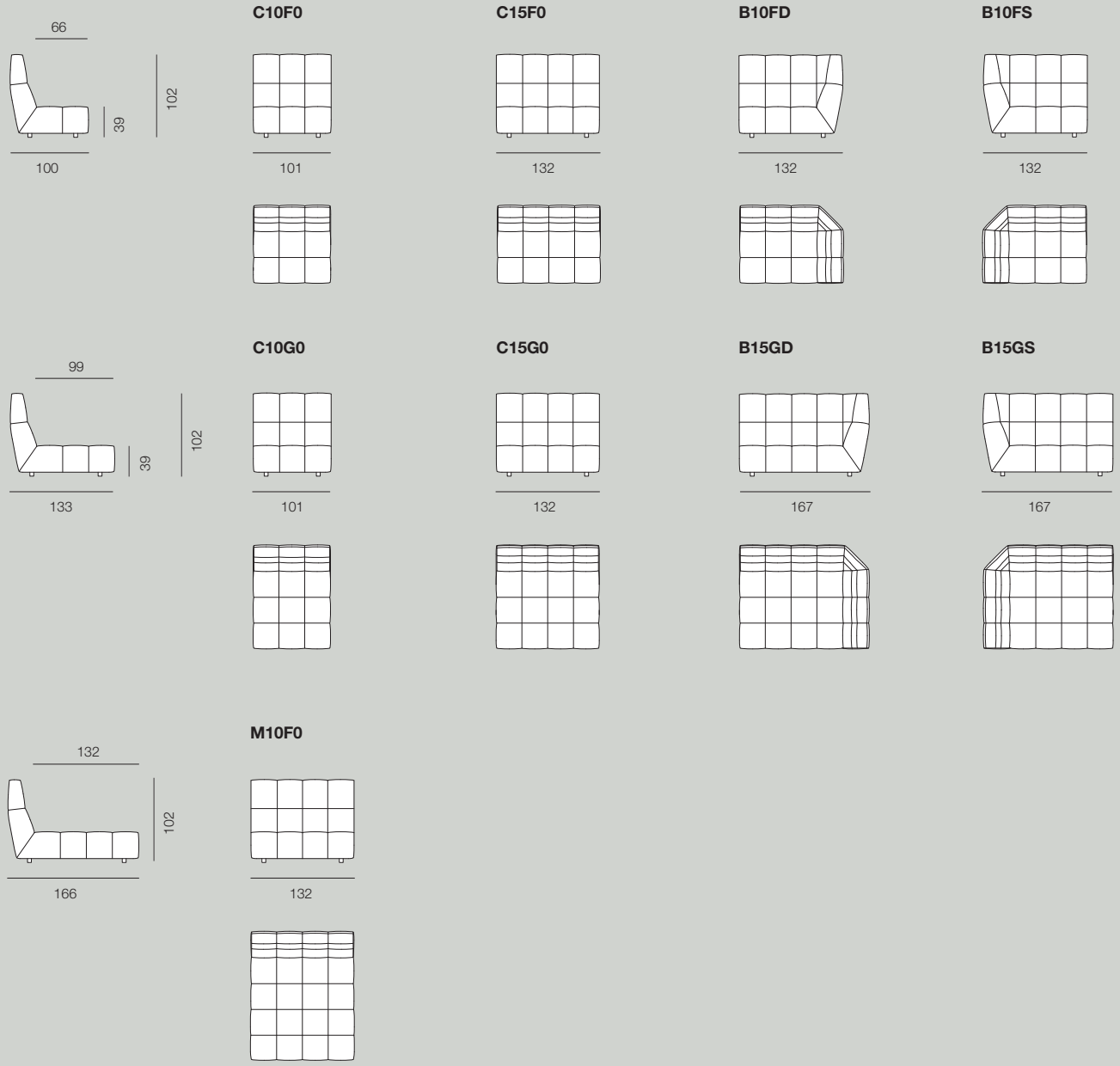

Pouf  
Pouf  
Poufs

Tavolini  
Side tables  
Tables basses

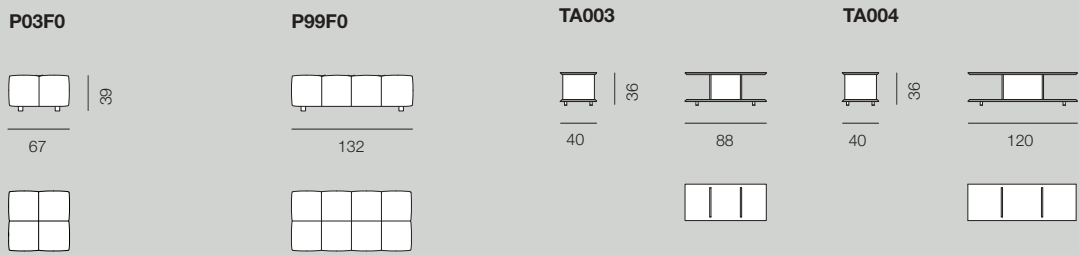

Q/bic

Q  
/  
b  
i  
c













IT → Q/Bic: tessuto Cool 600 / tessuto Cool 801  
EN → Q/Bic: fabric Cool 600 / fabric Cool 801  
FR → Q/Bic: tissu Cool 600 / tissu Cool 801

1



2



3



4









IT → **Q/Bic: tessuto Cool 600 / tessuto Cool 603**  
EN → *Q/Bic: fabric Cool 600 / fabric Cool 603*  
FR → *Q/Bic: tissu Cool 600 / tissu Cool 603*



# Q/bic

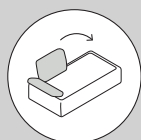

**Esempi di composizioni**  
**Examples of compositions**  
**Exemples de compositions**

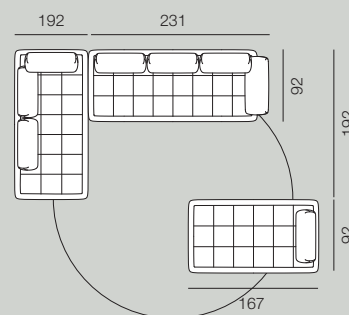
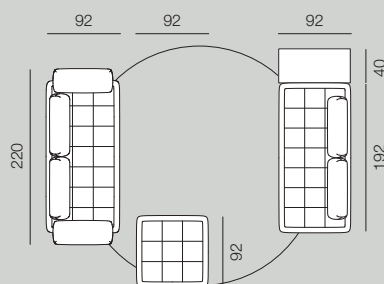
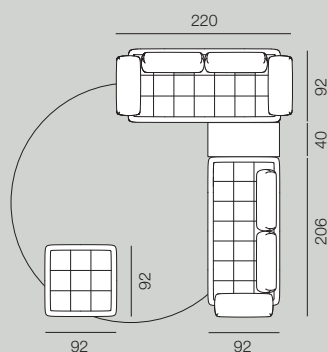

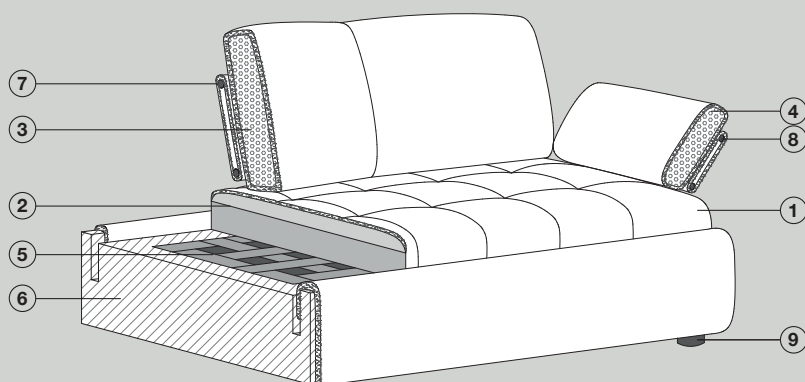

1 / Rivestimento  
 2 / Imbottitura seduta: poliuretano espanso HT 35 kg/m<sup>3</sup> ricoperto con resinato accoppiato  
 3 / Imbottitura schienale: piuma d'oca  
 4 / Imbottitura bracciolo: piuma d'oca  
 5 / Sistema di molleggio: cinghie elastiche incrociate  
 6 / Struttura portante: legno massello e multistrato con parti in agglomerato  
 7 / Struttura schienale: supporto in metallo  
 8 / Struttura bracciolo: supporto in metallo  
 9 / Piedi in ABS antiscivolo

1 / Sofa covering  
 2 / Seat padding: expanded polyurethane HT 35 kg/m<sup>3</sup> covered with coupled wadding resin  
 3 / Backrest padding: feather  
 4 / Armrest padding: feather  
 5 / Springing: suspension with elastic crossing belts  
 6 / Structure: solid wood and multilayer frame with parts in plywood and particle board  
 7 / Backrest structure: metal support  
 8 / Armrest structure: metal support  
 9 / Antislip ABS feet

1 / Revêtement  
 2 / Rembourrage assise: polyuréthane expansé HT 35 Kg/m<sup>3</sup> recouvert en résiné couplé  
 3 / Rembourrage dossier: plume d'oie  
 4 / Rembourrage accoudoir: plume d'oie  
 5 / Système de suspension: sangles élastiques entrecroisées  
 6 / Structure portante: bois massif et panneaux agglomérés ou multicouche  
 7 / Structure dossier: support en métal  
 8 / Structure accoudoir: support en métal  
 9 / Pieds ABS antidérapant

**Finiture metallo**  
**Metal finishes**  
**Finitions métalliques**



306



M312



55

**Divani  
Sofas  
Canapés**

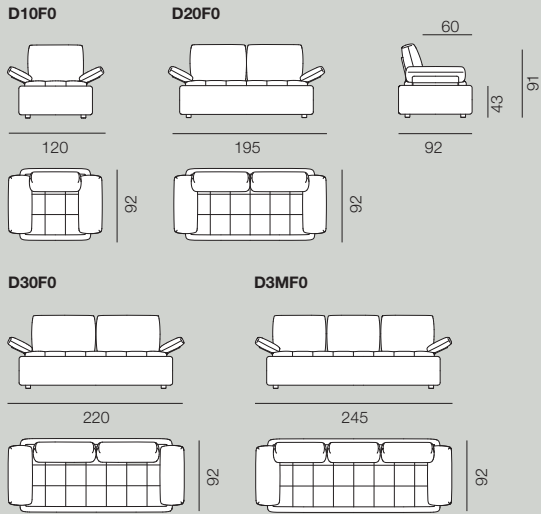

**Elementi centrali  
Central elements  
Banquettes**

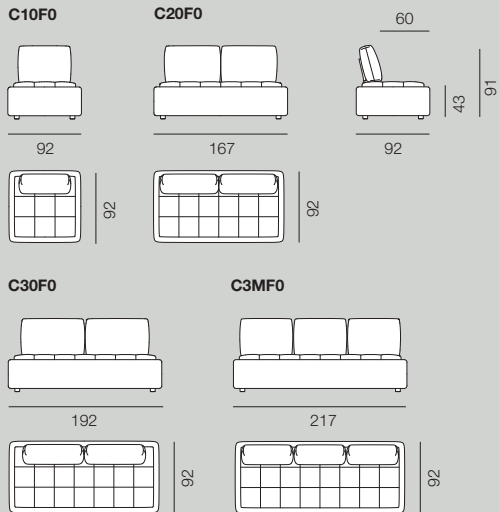

**Basi senza schienali  
Bases without backrests  
Banquettes sans dossiers**

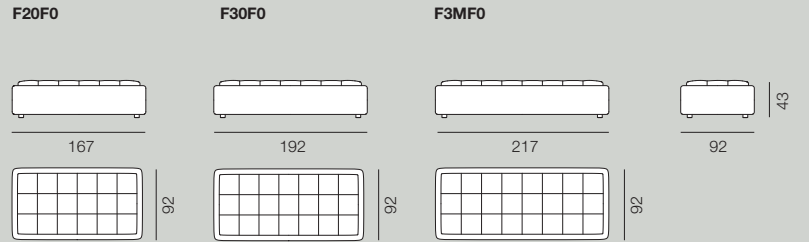

**Pouf  
Pouf  
Poufs**

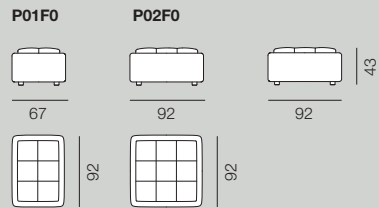

**Tavolo Antracite A414  
Anthracite Table A414  
Table Anthracite A414**

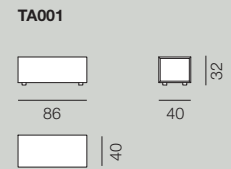

**Schienali  
Backrests  
Dossiers**

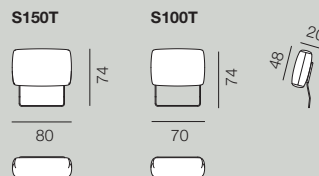

**Poggiatesta  
Headrest  
Appui-tête**

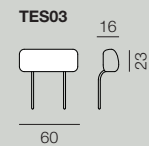

**Bracciolo  
Armrest  
Accoudoir**

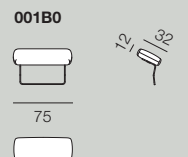

**Elementi terminali**  
Terminal elements  
Batards

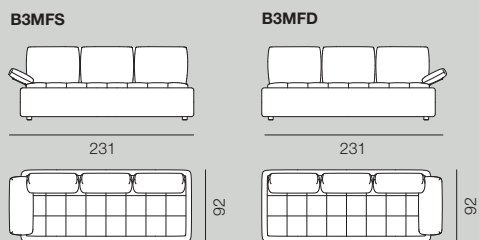
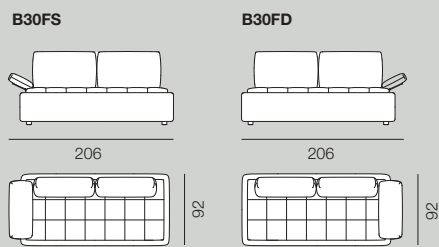
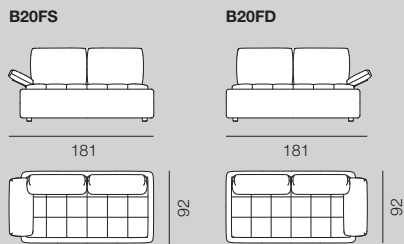
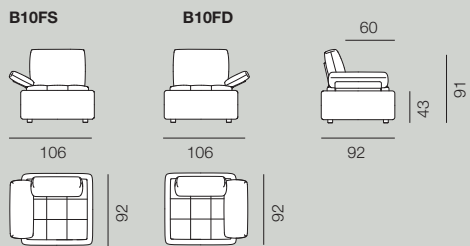

**Chaise longue**  
Chaise longue  
Chaises longues

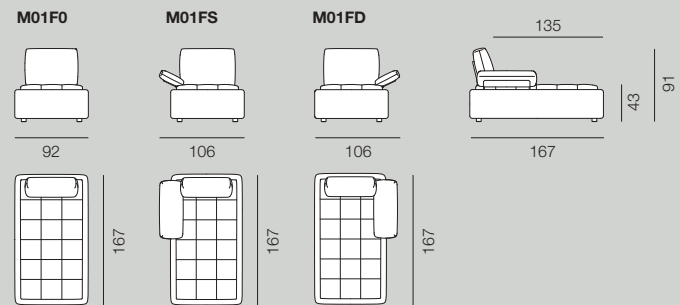

**Angolari**  
Corner elements  
Éléments d'angle

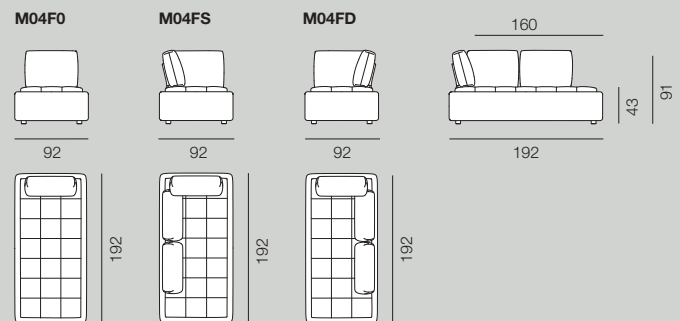

# Nexy Young & Flot

Ne.  
xi.  
Yo  
un  
g  
&  
Fl  
ot









IT → **Nexi Chic: tessuto Frisé 805 / tessuto Leida 48**

EN → *Nexi Chic: fabric Frisé 805 / fabric Leida 48*

FR → *Nexi Chic: tissu Frisé 805 / tissu Leida 48*

IT → **Flot: tessuto Frisé 305 / tessuto Frisé 814**

EN → *Flot: fabric Frisé 305 / fabric Frisé 814*

FR → *Flot: tissu Frisé 305 / tissu Frisé 814*



IT → **Nexi Chic: tessuto Frisé 805 / tessuto Leida 48**  
EN → *Nexi Chic: fabric Frisé 805 / fabric Leida 48*  
FR → *Nexi Chic: tissu Frisé 805 / tissu Leida 48*



# Nexi Young



**Esempi di composizioni**  
**Examples of compositions**  
**Exemples de compositions**

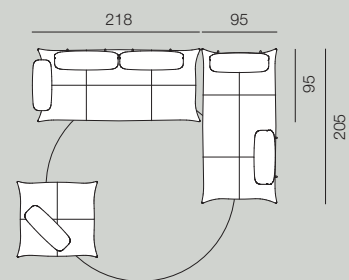
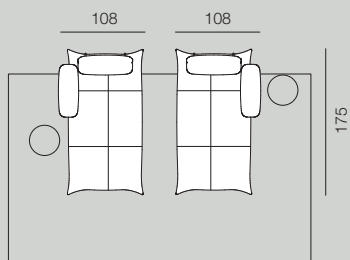
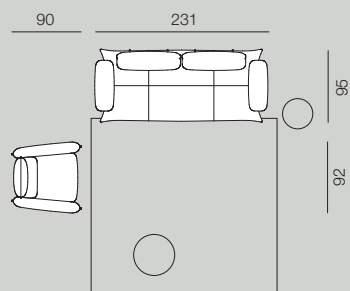

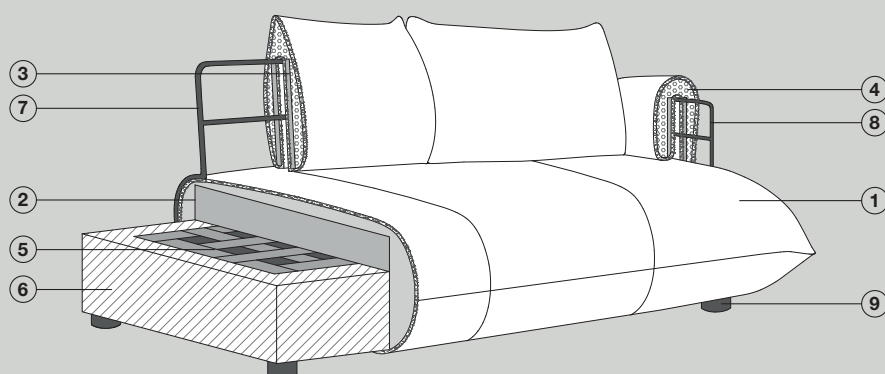
**1 / Rivestimento**

**2 / Imbottitura seduta:** poliuretano espanso HT 35 kg/m<sup>3</sup> ricoperto con resinato accoppiato

**3 / Imbottitura schienale:** poliuretano espanso e piuma d'oca

**4 / Imbottitura bracciolo:** poliuretano espanso e piuma d'oca

**5 / Sistema di molleggio:** cinghie elastiche incrociate

**6 / Struttura portante:** legno massello e multistrato con parti in agglomerato

**7 / Struttura schienale:** supporto in metallo

**8 / Struttura bracciolo:** supporto in metallo

**9 / Piedi in ABS** antiscivolo

**1 / Sofa covering**

**2 / Seat padding:** expanded polyurethane HT 35 kg/m<sup>3</sup> covered with coupled wadding resin

**3 / Backrest padding:** expanded polyurethane and feather

**4 / Armrest padding:** expanded polyurethane and feather

**5 / Springing:** suspension with elastic crossing belts

**6 / Structure:** solid wood and multilayer frame with parts in plywood and particle board

**7 / Backrest structure:** metal support

**8 / Armrest structure:** metal support

**9 / Antislip** ABS feet

**1 / Revêtement**

**2 / Rembourrage assise:** polyuréthane expansé HT 35 Kg/m<sup>3</sup> recouvert en résiné couplé

**3 / Rembourrage dossier:** polyuréthane expansé et plume d'oie

**4 / Rembourrage accoudoir:** polyuréthane expansé et plume d'oie

**5 / Système de suspension:** sangles élastiques entrecroisées

**6 / Structure portante:** bois massif et panneaux agglomérés ou multicouche

**7 / Structure dossier:** support en métal

**8 / Structure accoudoir:** support en métal

**9 / Pieds** ABS antidérapant

**Finiture metallo****Metal finishes****Finitions métalliques**

306



M312



55

**Divani  
Sofas  
Canapés**

**D20F0**

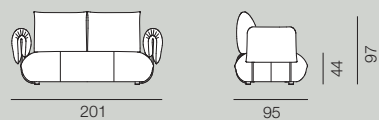

**D30F0**

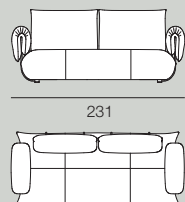

**D3MF0**

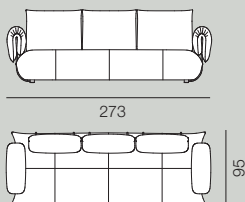

**Elementi centrali  
Central elements  
Banquettes**

**C10F0**

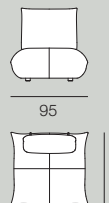

**C20F0**

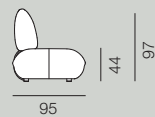
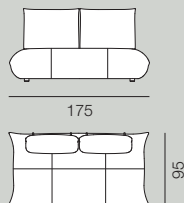

**C30F0**

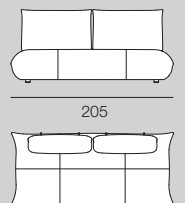

**C3MF0**

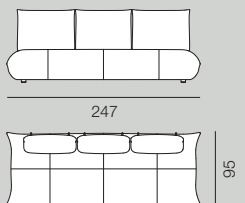

**Basi senza schienali  
Bases without backrests  
Banquettes sans dossiers**

**F20F0**

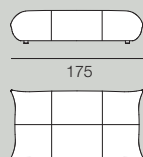

**F30F0**

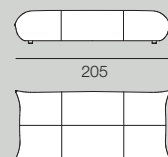

**F3MF0**

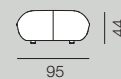
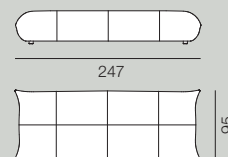

**Pouf  
Pouf  
Poufs**

**P01F0**



**P02F0**

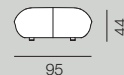
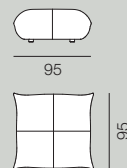

**Schienali  
Backrests  
Dossiers**

**S150T**

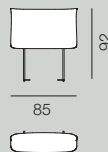

**S100T**

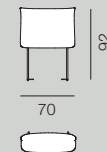

**Bracciolo  
Armrest  
Accoudoir**

**001B0**

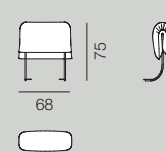



**Elementi terminali**  
**Terminal elements**  
**Batards**

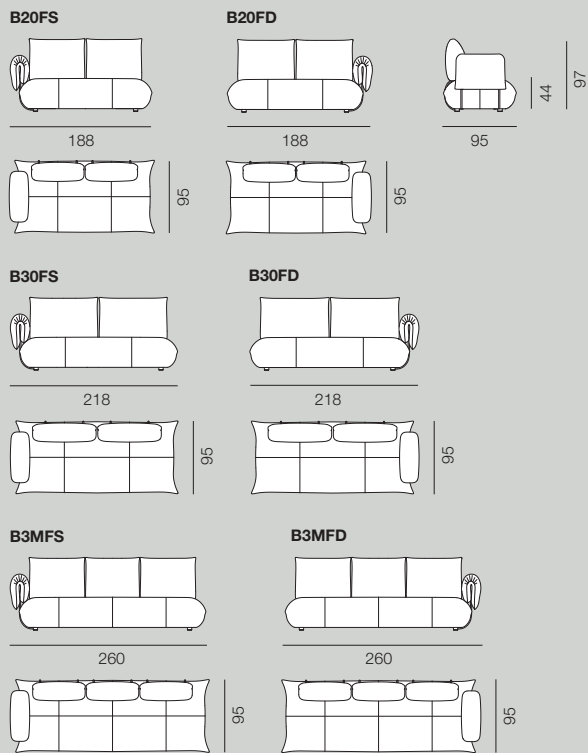

**Chaise longue**  
**Chaise longue**  
**Chaises longues**

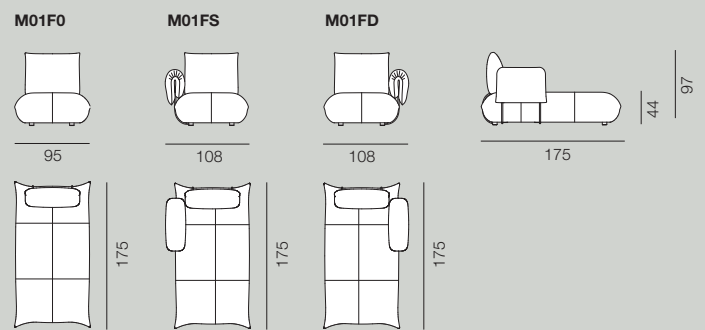

**Angolari**  
**Corner elements**  
**Éléments d'angle**

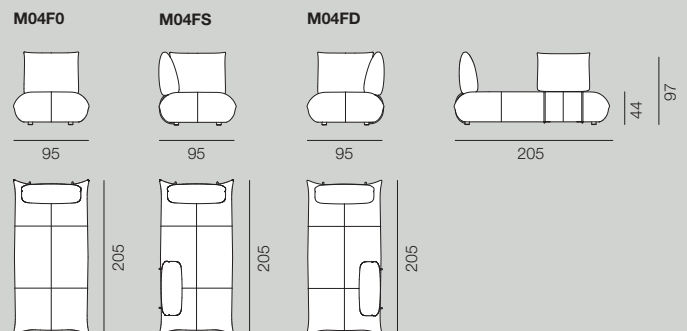

Flot

Flot





# Flot

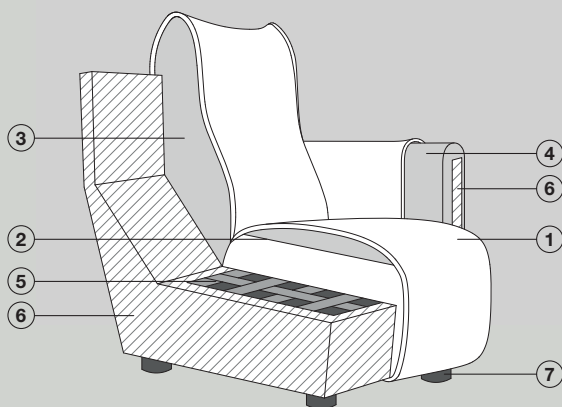

1 / Rivestimento  
 2 / Imbottitura seduta: poliuretano espanso 40 kg/m<sup>3</sup> ricoperto con resinato accoppiato  
 3 / Imbottitura schienale: poliuretano espanso ricoperto con resinato accoppiato  
 4 / Imbottitura bracciolo: poliuretano espanso ricoperto con resinato accoppiato  
 5 / Sistema di molleggio: cinghie elastiche incrociate  
 6 / Struttura portante: legno massello e multistrato con parti in agglomerato  
 7 / Piedi in ABS antiscivolo disponibile con basamento girevole

1 / Sofa covering  
 2 / Seat padding: expanded polyurethane 40 kg/m<sup>3</sup> covered with coupled wadding resin  
 3 / Backrest padding: expanded polyurethane covered with coupled wadding resin  
 4 / Armrest padding: expanded polyurethane covered with coupled wadding resin  
 5 / Springing: suspension with elastic crossing belts  
 6 / Structure: solid wood and multilayer frame with parts in plywood and particle board  
 7 / Antislip ABS feet available with swivel base

1 / Revêtement  
 2 / Rembourrage assise: polyuréthane expansé 40 Kg/m<sup>3</sup> recouvert en résiné couplé  
 3 / Rembourrage dossier: polyuréthane expansé recouvert en résiné couplé  
 4 / Rembourrage accoudoir: polyuréthane expansé recouvert en résiné couplé  
 5 / Système de suspension: sangles élastiques entrecroisées  
 6 / Structure portante: bois massif et panneaux agglomérés ou multicouche  
 7 / Pieds ABS antidérapant disponible avec base pivotante

## Poltrona Armchair Fauteuil

D10F0

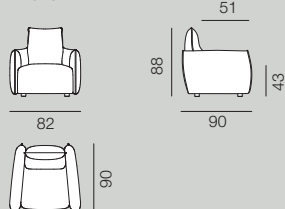

## Poltrona girevole Armchair with swivel base Fauteuil base pivotante

D10G0

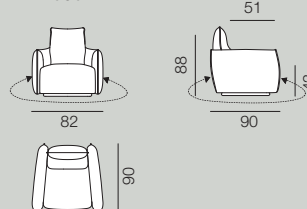





IT → Shore: tessuto Bazar 25 / tessuto Bazar 19

EN → Shore: fabric Bazar 25 / fabric Bazar 19

FR → Shore: tissu Bazar 25 / tissu Bazar 19



1



2









IT → **Shore: tessuto Bazar 25 / tessuto Bazar 19**  
EN → *Shore: fabric Bazar 25 / fabric Bazar 19*  
FR → *Shore: tissu Bazar 25 / tissu Bazar 19*



# Shore

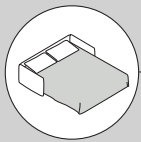

---

**Esempi di composizioni**  
**Examples of compositions**  
**Exemples de compositions**

---

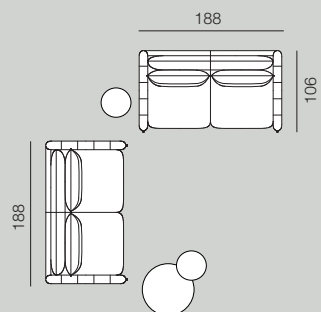

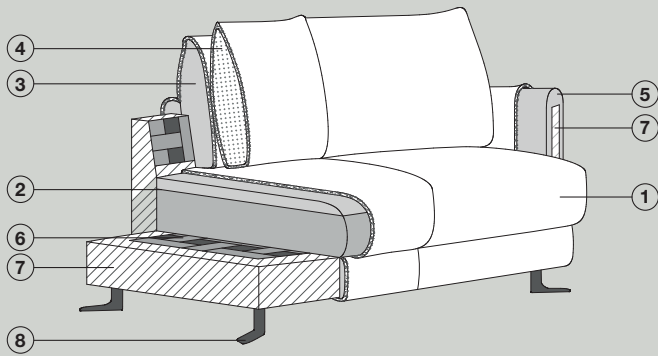

1 / Rivestimento  
 2 / Imbottitura seduta: poliuretano espanso HT 35 kg/m<sup>3</sup> ricoperto con resinato accoppiato  
 3 / Imbottitura schienale: poliuretano espanso ricoperto con resinato accoppiato  
 4 / Imbottitura cuscino schienale: fibra di poliestere sfioccato avvolta in tela in misto cotone  
 5 / Imbottitura bracciolo: poliuretano espanso ricoperto con resinato accoppiato  
 6 / Sistema di molleggio: cinghie elastiche incrociate nella versione fissa  
 7 / Struttura portante: legno massello e multistrato con parti in agglomerato  
 8 / Piedi in metallo

1 / Sofa covering  
 2 / Seat padding: expanded polyurethane HT 35 kg/m<sup>3</sup> covered with coupled wadding resin  
 3 / Backrest padding: expanded polyurethane covered with coupled wadding resin  
 4 / Backrest cushion padding: polyester fiber in cotton blend fabric  
 5 / Armrest padding: expanded polyurethane covered with coupled wadding resin  
 6 / Springing: suspension with elastic crossing belts in the fixed version  
 7 / Structure: solid wood and multilayer frame with parts in plywood and particle board  
 8 / Metal feet

1 / Revêtement  
 2 / Rembourrage assise: polyuréthane expansé HT 35 Kg/m<sup>3</sup> recouvert en résiné couplé  
 3 / Rembourrage dossier: polyuréthane expansé recouvert en résiné couplé  
 4 / Rembourrage coussin dossier: fibre de polyester en flocons enveloppée dans une toile en coton mixte  
 5 / Rembourrage accoudoir: polyuréthane expansé recouvert en résiné couplé  
 6 / Système de suspension: sangles élastiques entrecroisées en version fixe  
 7 / Structure portante: bois massif et panneaux agglomérés ou multicouche  
 8 / Pieds en métal

**Finiture metallo**  
**Metal finishes**  
**Finitions métalliques**



55

**Divani letto**  
**Sofas with bed**  
**Canapé-lit**

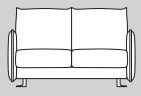
**\* D25L0**

168

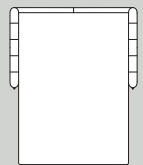

120

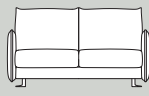
**\* D30L0**

188

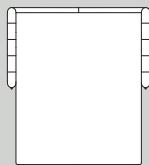

140

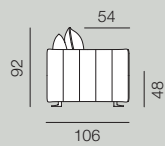

106

**Bracciolo**  
**Armrest**  
**Accoudoir**

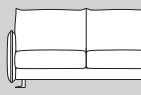

11

**\* D3ML0**

208

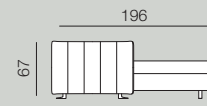

204

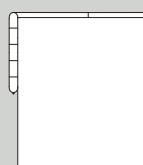

160

\* Versioni fisse senza rete NON DISPONIBILI  
 \* Fixed version without bed NOT AVAILABLE  
 \* Version fixe sans sommier NON DISPONIBLE





IT → **Virgo: tessuto Cinema 37 / tessuto Cool 713**  
EN → *Virgo: fabric Cinema 37 / fabric Cool 713*  
FR → *Virgo: tissu Cinema 37 / tissu Cool 713*



1



2









IT → **Virgo: tessuto Cinema 37 / tessuto Cool 713**  
EN → *Virgo: fabric Cinema 37 / fabric Cool 713*  
FR → *Virgo: tissu Cinema 37 / tissu Cool 713*



# Virgo

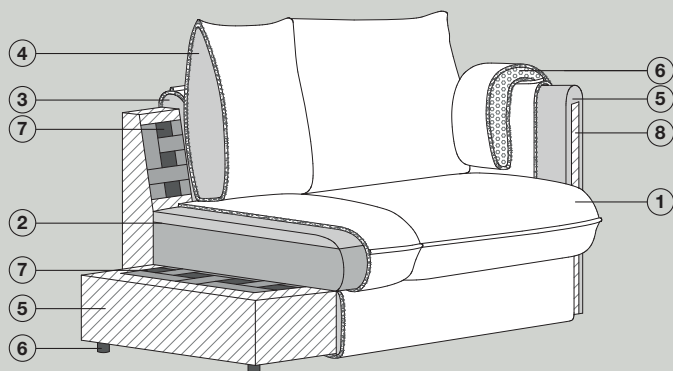
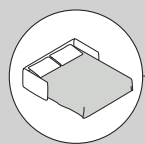

1 / Rivestimento

2 / Imbottitura seduta: poliuretano espanso HT 35 kg/m<sup>3</sup> ricoperto con resinato accoppiato

3 / Imbottitura schienale: poliuretano espanso ricoperto con resinato accoppiato

4 / Imbottitura cuscino schienale: poliuretano espanso a densità differenziata ricoperto con resinato accoppiato

5 / Imbottitura bracciolo: poliuretano espanso ricoperto con resinato accoppiato

6 / Imbottitura cuscino bracciolo: piuma d'oca

7 / Sistema di molleggio: cinghie elastiche incrociate

8 / Struttura portante: legno massello e multistrato con parti in agglomerato

9 / Piedi a spillo (non visibili)

1 / Sofa covering

2 / Seat padding: expanded polyurethane HT 35 kg/m<sup>3</sup> covered with coupled wadding resin

3 / Backrest padding: expanded polyurethane covered with coupled wadding resin

4 / Backrest cushion padding: expanded polyurethane in variable density covered with coupled wadding resin

5 / Armrest padding: expanded polyurethane covered with coupled wadding resin

6 / Backrest cushion padding: feather

7 / Springing: suspension with elastic crossing belts

8 / Structure: solid wood and multilayer frame with parts in plywood and particle board

9 / Cylindrical feet (not visible)

1 / Revêtement

2 / Rembourrage assise: polyuréthane expansé HT 35 Kg/m<sup>3</sup> recouvert en résiné couplé

3 / Rembourrage dossier: polyuréthane expansé recouvert en résiné couplé

4 / Rembourrage coussin dossier: polyuréthane expansé multi-densité recouvert en résiné couplé

5 / Rembourrage accoudoir: polyuréthane expansé recouvert en résiné couplé

6 / Rembourrage coussin accoudoir: plume d'oie

7 / Système de suspension: sangles élastiques entrecroisées

8 / Structure portante: bois massif et panneaux agglomérés ou multicouche

9 / Pieds cylindriques (non visibles)

**Divani  
Sofas  
Canapés**

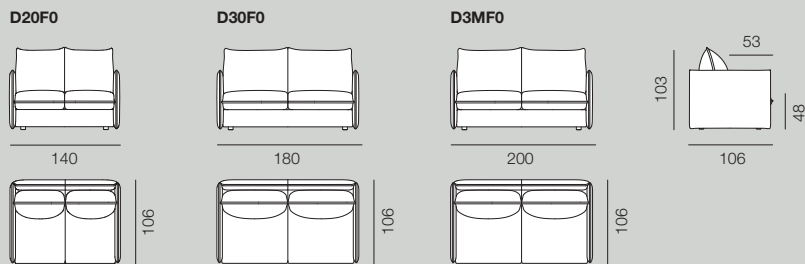

**Divani letto  
Sofas with bed  
Canapés-lit**

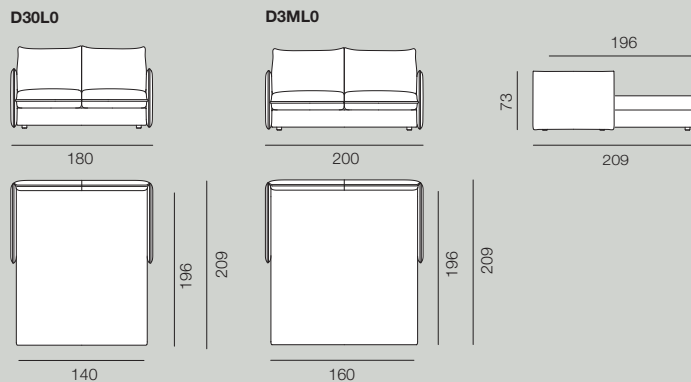

**Elementi terminali  
Terminal elements  
Batards**

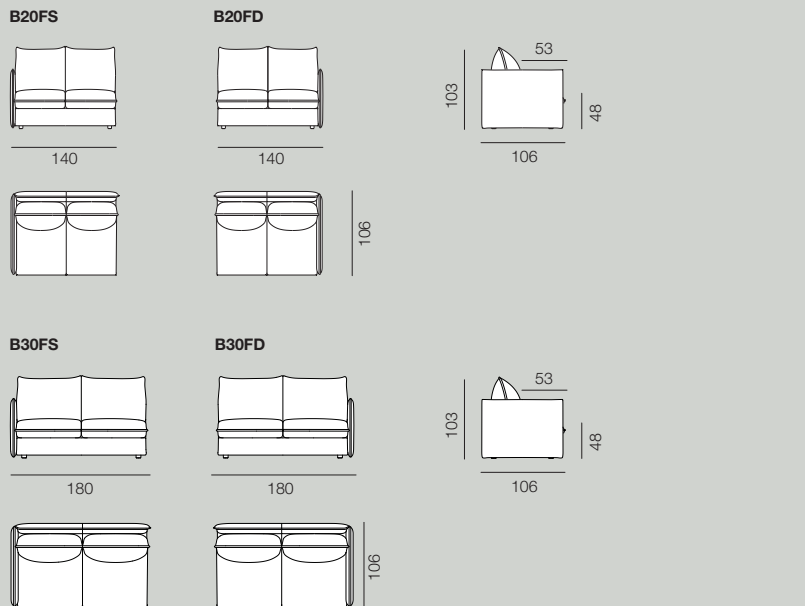

**Elementi terminali  
Terminal elements  
Batards-lit**

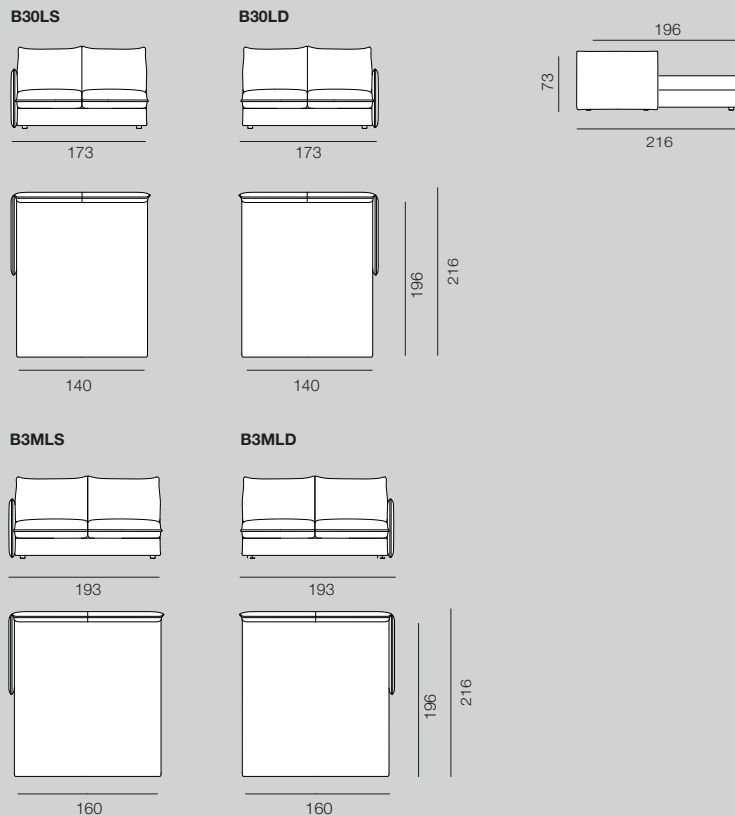

**Terminal elements**

**Bracciolo  
Armrest  
Accoudoir**



**Cuscino bracciolo  
Armrest cushion  
Coussin accoudoir**

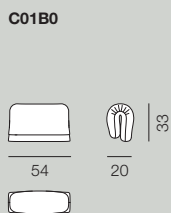

**Chaise longue contenitore dx/sx  
Chaise longues with case right/left  
Chaise longue droite/gauche avec coffre**

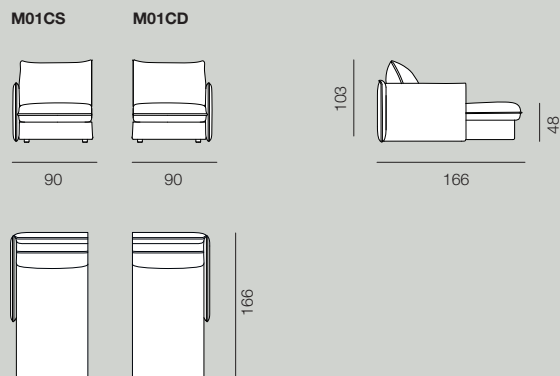



IT → **Finiture**

EN → **FINISHES**

FR → **FINITIONS**



# Materials

## Metalli Metals Métals

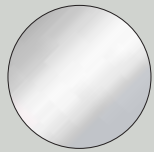

G093  
Cromo



306  
Laccato bianco opaco

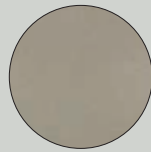

M312  
Laccato sabbia

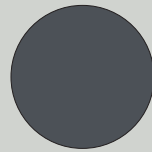

M310  
Laccato velvet antracite



TITANIO



55  
Laccato nero opaco

## Gros Grain



36  
Burro

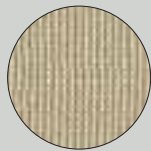

135  
Nuvola

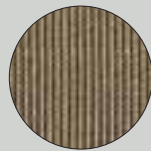

164  
Tortora

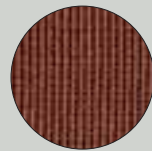

96  
Coccio

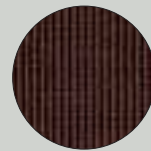

98  
Caramel

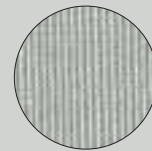

45  
Perla

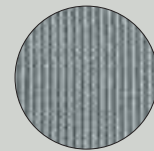

48  
Argento



42  
Acciaio

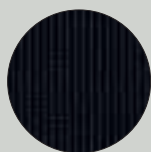

41  
Nero

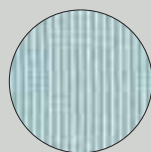

102  
Cielo

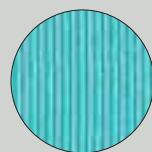

103  
Fonte

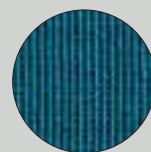

137  
Petrolio

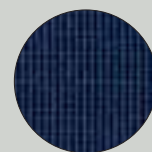

114  
Abisso

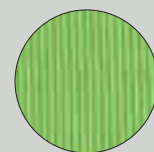

100  
Mela

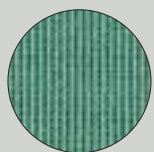

106  
Giada



132  
Bottiglia

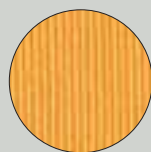

64  
Sole

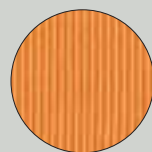

72  
Mandarino

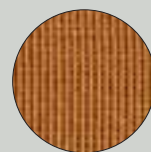

68  
Ambra

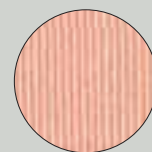

77  
Cipria

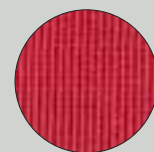

86  
Corallo

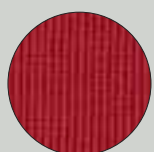

84  
Rosso

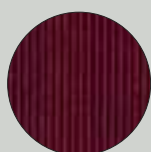

88  
Amaranto

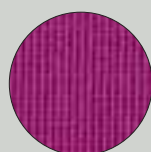

71  
Fuxia

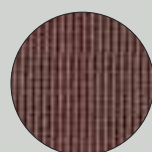

159  
Vino

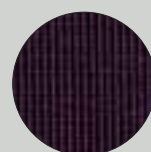

158  
Mirtillo



Colori per cucitura a contrasto  
 Color for stitching in contrast  
 Couleurs pour coutures contrastées



0002



1302

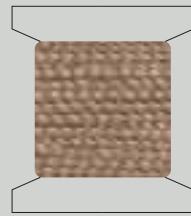

1770

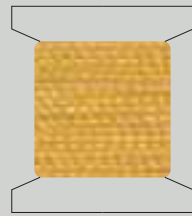

1892

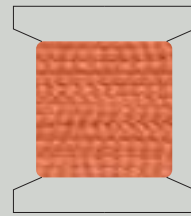

1129

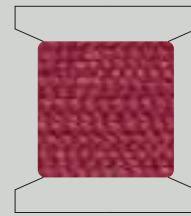

1055

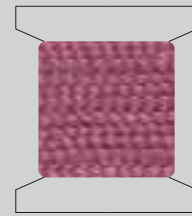

1888

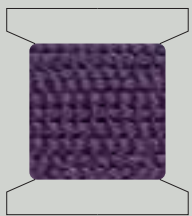

7015

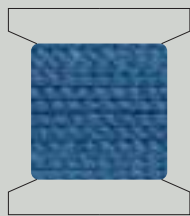

7300

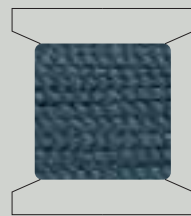

7799

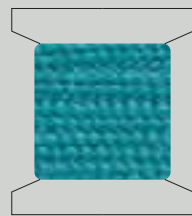

7722

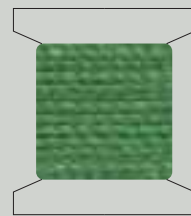

4224

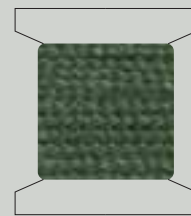

3627

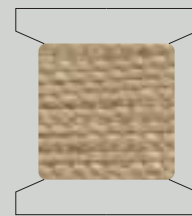

1349

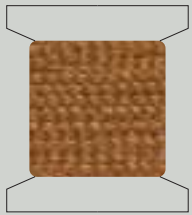

1248

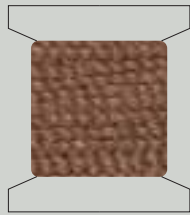

1813

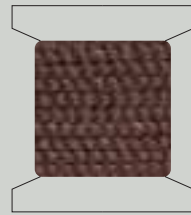

1222

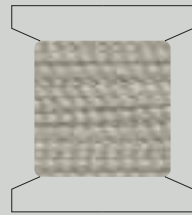

2560

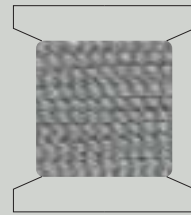

0015

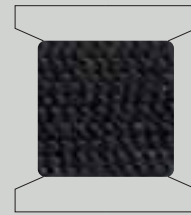

0003

# Legenda

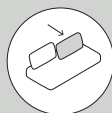

Schienale regolabile  
Adjustable backrest  
Dossier réglable

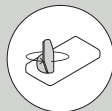

Schienale posizionabile liberamente  
Removable backrest freely placeable  
Dossier amovible

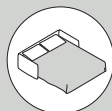

Divano letto  
Sofa with bed  
Canapé-lit



Basamento girevole  
Swivel base  
Base pivotante

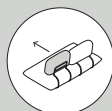

Cuscino schienale regolabile  
Adjustable backrest cushion  
Coussin de dossier réglable

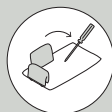

Schiene e braccioli posizionabili liberamente lungo il perimetro del divano con l'ausilio di un cacciavite  
Backrests and armrests can be freely positioned along the perimeter of the sofa with the aid of a screwdriver  
Dossiers et accoudoirs amovibles positionables sur toute la surface du canapé avec l'aide d'un tournevis

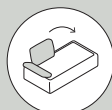

Schiene e braccioli posizionabili liberamente lungo il perimetro del divano  
Backrests and armrests can be freely positioned along the perimeter of the sofa  
Dossiers et accoudoirs amovibles positionables librement sur toute la surface du canapé

**Art direction** Genny Canton Studio  
**Photos** Paolo Contratti  
**Styling** Genny Canton Studio  
**Digital images** Genny Canton Studio  
**Separation** Studio Emmequadro  
**Printing** Grafiche Antiga



stampato  
con il sole

**AERRE ITALIA®**  
Family Business. since 1975

**A.R srl**  
Via Nicola Sacco, 33  
47122 Forlì (FC) - Italy  
Tel. +39 0543 481529  
Fax +39 0543 481537  
www.aerreitalia.com  
info@erreitalia.com

Le immagini, le finiture e le specifiche tecniche rappresentate sono da ritenersi puramente indicative. Possono essere apportate delle modifiche, se ritenute opportune, per migliorare in qualunque momento e senza alcun obbligo di preavviso. Si declina ogni responsabilità per danni causati dall'uso non corretto dei prodotti e per eventuali indicazioni inesatte o errori di stampa contenuti nel presente catalogo.

The photos, finishes and specifications shown are to be considered only as examples. Changes can be made at any time without any prior notice if needed. We do not accept responsibility for damage caused by improper use of the product and for any incorrect information or misprints contained in this catalogue.



**AERRE ITALIA®**  
Family Business, since 1975

# AAA Atelier



[www.aerreitalia.com](http://www.aerreitalia.com)