



# JOYFULL

sofas & armchairs

**AERRE ITALIA**  
Family Business, since 1975



**AERRE ITALIA®**  
Family Business, since 1975



Con le proprie creazioni Aerre Italia, design by Andrea Arena crea un nuovo stile dell'abitare: un "design da vivere, da indossare e respirare". Grazie ad un gioco di armonici rimandi tra emozioni estetiche, tattili e funzionali, Aerre Italia coinvolge tutti i sensi consentendo di godere spazi personali in cui trova spazio un'esperienza giornaliera di "comfort" nella quale celebrare il ritrovato contatto con se stessi.

With their own creations Aerre Italia, design by Andrea Arena creates a new style of living: a "design to live, to wear and breathe". Thanks to a game of harmonious references between aesthetic, tactile and functional emotions, Aerre Italia involves all the senses allowing you to enjoy personal spaces in which to find a daily experience of "comfort" and celebrate the rediscovered contact with oneself.

A travers les propres créations Aerre Italia, design by Andrea Arena crée un nouveau style de vie : un « design à vivre, à porter et à respirer ». Grâce à un jeu de références harmoniques entre émotions esthétiques, tactiles et fonctionnelles, Aerre Italia fait appel à tous les sens pour profiter des espaces personnels dans lesquels il trouve sa place, une expérience quotidienne de « Confort » pour célébrer le contact retrouvé avec soi-même.



ANDREA  
ARENA  
COLLEC  
\_TION



Genuinamente “Made in Italy” e realizzati con grande attenzione all’ambiente e all’utilizzatore, i prodotti Aerre Italia incarnano una nuova sensibilità nell’arredare, attenta all’eleganza e al fascino degli oggetti come al loro contenuto etico.

Genuinely “Made in Italy” and created with great care to the environment and people, Aerre Italia’s products embody a new sensitivity in furnishing, attentive to the elegance and charm of objects as well as their ethical content.



Véritablement “Made in Italy” et faits avec beaucoup d’attention envers l’environnement et l’utilisateur, les produits Aerre Italia incarnent une nouvelle sensibilité dans l’ameublement, attentifs à l’élégance et au charme des objets autant qu’à leur contenu éthique.

**\_MADE  
IN ITALY  
\_SENSIBILITÀ  
E FASCINO  
NELL'ARREDARE  
\_SENSITIVITY  
AND CHARM IN  
FURNISHING  
\_ DE LA  
SENSIBILITÉ ET  
DU CHARME DANS  
L'AMEUBLEMENT**



Aerre Italia crede che innovare significhi soddisfare sogni e anticipare bisogni: non solo inventare nuove soluzioni stilistiche o progettuali per l'interior design e per il benessere, ma anche rispettare l'ambiente, con nuove tecnologie, nuovi processi produttivi, nuovi materiali.

Aerre Italia believes that innovating means satisfying dreams and anticipating needs: not only invent new stylistic solutions for the interior design and for the well-being, but also respect to the environment, with new technologies, new production processes, new materials.

Pour Aerre Italia, innover signifie réaliser des rêves et anticiper des besoins : ce n'est pas seulement inventer de nouvelles solutions stylistiques ou de projets d'intérieur et pour le bien-être, mais c'est aussi le respect l'environnement, avec de nouvelles technologies, de nouveaux procédés de production, de nouveaux matériaux.



**\_SODDISFARE  
I SOGNI  
ANTICIPANDO  
I BISOGNI  
\_SATISFY  
DREAMS  
ANTICIPATING  
NEEDS  
\_SATISFAIRE  
LES RÊVES  
EN ANTICIPANT  
LES BESOINS**



I progetti Aerre Italia nascono dalla libertà creativa di Andrea Arena e dal suo tratto sempre originale, con una passione per gli oggetti che si liberano dalla funzione codificata e prescritta per reinventarsi a nuovi usi: prodotti empatici, amichevoli, godibili. Oggetti che migliorano la vita delle persone.

Aerre Italia projects are born from Andrea Arena creative freedom and its always original trait, with a passion for objects that free themselves from the encoded function to be reinvented to new uses: empathic, friendly products, enjoyable. Objects that improve people's lives.

Les projets Aerre Italia sont nés de la liberté créative d'Andrea Arena et de sa vision toujours originale, avec la passion pour les objets qui se démarquent des formes conventionnelles et prescrites pour se réinventer au travers de nouvelles fonctions : des produits empathiques, conviviaux et agréables. Autrement dit, des objets qui améliorent le quotidien.

\_UN  
NUOVO  
STILE DA  
ABITARE  
\_A NEW  
STYLE  
OF  
LIVING  
\_UN  
NOUVEAU  
STYLE À  
VIVRE

Soap  
Comfy

14  
Yellow



24  
Gemini



32  
Libra



46  
Gardenia



Fluffy  
Comfy

96  
Albatros

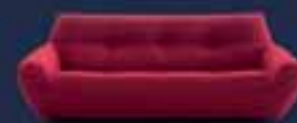

Modular  
Comfy

138  
Ibiza



148  
Gipsy



156  
Deneris



Sofa  
\_bed

182  
Smoothie



192  
Nappy



Easy  
\_chairs

238  
Celine





**56**  
Wallet



**66**  
Cosy



**74**  
Libes



**82**  
Dumble



**108**  
Jinga



**118**  
Sambo



**126**  
Yume



**174**  
Caribe



**202**  
Mango



**212**  
Dorico



**220**  
Amandine



**230**  
Texas



**244**  
Gea



**250**  
Dixi



**258**  
Alex



14  
Yellow



24  
Gemini



32  
Libra



# SOAP COMFY

**46**  
Gardenia



**56**  
Wallet



**66**  
Cosy



**74**  
Libes



**82**  
Dumble



Un tocco estetico personale. Un'intensità di ricerca e creazione volta a trasformare l'ordinario in straordinario, le forme e i materiali in emozioni.

A personal aesthetic touch. An intensity of research and creation aimed to transform ordinary to extraordinary, shapes and materials in emotions.

Une touche esthétique personnelle. Une intensité de recherche et de création visant à transformer l'ordinaire en extraordinaire, les formes et les matières en émotions.





# YELLOW

designed by Andrea Arena

Leggerezza e matericità, pieni e vuoti: un ricercato gioco di opposizioni crea un ritmo visivo dal forte appeal. Yellow disegna la leggerezza con la sua caratteristica struttura metallica. Una presenza originale e distintiva dove i solidi vengono stemperati dallo slancio dei piedini dalle linee stilose.

Lightness and materiality, solid and voids: a refined game of oppositions creates a visual rhythm with a strong appeal. Yellow draws lightness with its characteristic metal structure. One original and distinctive presence where the solids are tempered by the momentum of the feet with stylish lines.

Légèreté et matericité, volumes et vides : un jeu d'oppositions recherchées qui crée un rythme visuel attractif. Le Yellow représente la légèreté avec sa structure métallique caractéristique. Une présence originale et typique où la matière est adoucie par les lignes stylées de la structure.

— 1 Yellow:

tessuto Frida col.03 / tessuto Frida col.03 / metallo nero 55  
fabric Frida col.03 / fabric Frida col.03 / metal nero 55  
tissu Frida col.03 / tissu Frida col.03 / métal nero 55

— 2 Celine:

tessuto Frida col.03 / tessuto Frida col.03 / metallo nero 55  
fabric Frida col.03 / fabric Frida col.03 / metal nero 55  
tissu Frida col.03 / tissu Frida col.03 / métal nero 55











— 1 Yellow:  
tessuto Frida col.03 / tessuto Frida col.03 / metallo nero 55  
fabric Frida col.03 / fabric Frida col.03 / metal nero 55  
tissu Frida col.03 / tissu Frida col.03 / métal nero 55





# YELLOW



## Finiture metallo Metal finishes Finitions métalliques

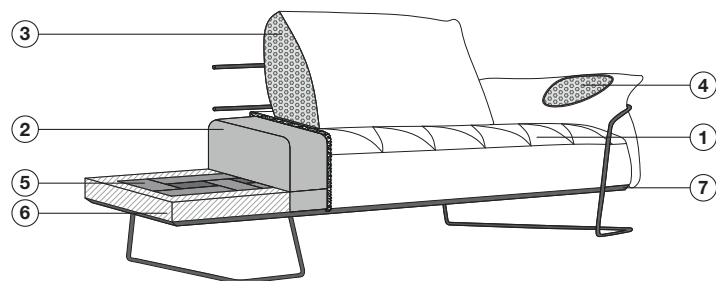
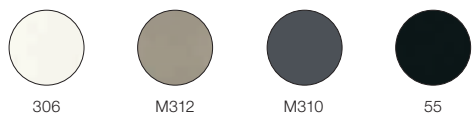

1 / Rivestimento  
2 / Imbottitura seduta: poliuretano espanso HT 35 kg/m<sup>3</sup> ricoperto con resinato accoppiato  
3 / Imbottitura schienale: piuma d'oca  
4 / Imbottitura bracciolo: piuma d'oca  
5 / Sistema di molleggio: cinghie elastiche incrociate  
6 / Struttura portante: metallo, legno massello e multistrato con parti in agglomerato  
7 / Struttura metallica

1 / Sofa covering  
2 / Seat padding: expanded polyurethane HT 35 kg/m<sup>3</sup> covered with coupled wadding resin  
3 / Backrest padding: feather  
4 / Armrest padding: feather  
5 / Springing: suspension with elastic crossing belts  
6 / Structure: metal, solid wood and multilayer frame with parts in plywood and particle board  
7 / Metal structure

1 / Revêtement  
2 / Rembourrage assise: polyuréthane expansé HT 35 Kg/m<sup>3</sup> recouvert en résiné couplé  
3 / Rembourrage dossier: plume d'oie  
4 / Rembourrage accoudoir: plume d'oie  
5 / Système de suspension: sangles élastiques entrecroisées  
6 / Structure portante: métal, bois massif et panneaux agglomérés ou multicouche  
7 / Structure en métal

**Poltrona  
Armchair  
Fauteuil**

**D10F0**

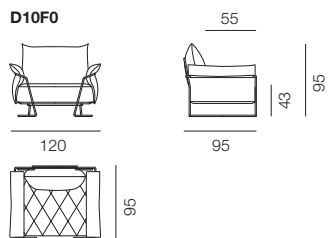

**Pouf  
Pouf  
Pouf**

**P01F0**

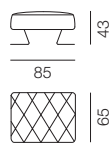

**Poggiareni  
Lumbar support  
Cale reins**

**R8001**



**Divani  
Sofas  
Canapés**

**D20F0**

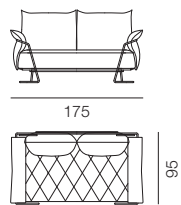

**D25F0**

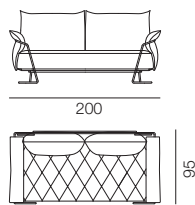

**D30F0**

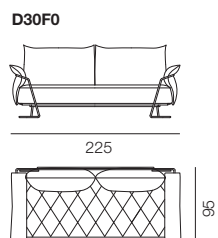

**Poggiatesta  
Headrest  
Appuie-tête**

**TES03**

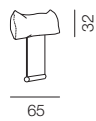







# GEMINI

designed by Andrea Arena

Un'eleganza informale e una morbidezza chic vestono gli spazi di creatività dando vita a un'atmosfera di carattere e ad ambienti decisi, pensati per raccontare storie e momenti. Un aspetto in divenire che permette di giocare con i volumi trasformando le potenzialità del design e del colore in piacevoli momenti di vita.

Informal elegance and stylish softness add a creative touch to settings with an atmosphere full of character, perfect for telling stories and creating memories. This aspect allows you to play with volumes and transform design and colour into pleasant moments in life.

Une élégance informelle et une souplesse chic habillent les espaces de créativité et ainsi donnent vie à une atmosphère de caractère et à des environnements bien définis, pensés pour raconter des histoires et des moments. Un aspect en devenir qui permet de jouer avec les volumes en transformant les potentialités du design et du coloris choisi en d'agréables moments de vie.

— **1 Gemini:**  
tessuto Cinema col.49 / tessuto Frise col.305  
fabric Cinema col.49 / fabric Frise col.305  
tissu Cinema col.49 / tissu Frise col.305

— **2 Gemini:**  
tessuto Frise col.305  
fabric Frise col.305  
tissu Frise col.305

— **3 Gemini:**  
tessuto Amadeus col.07  
fabric Amadeus col.07  
tissu Amadeus col.07

— **4 Gemini:**  
tessuto Amadeus col.07 / tessuto Sinfonia col.07  
fabric Sinfonia col.07 / fabric Sinfonia col.07  
tissu Sinfonia col.07 / tissu Sinfonia col.07

— **5 Gemini:**  
tessuto Sinfonia col.07  
fabric Sinfonia col.07  
tissu Sinfonia col.07





4

5





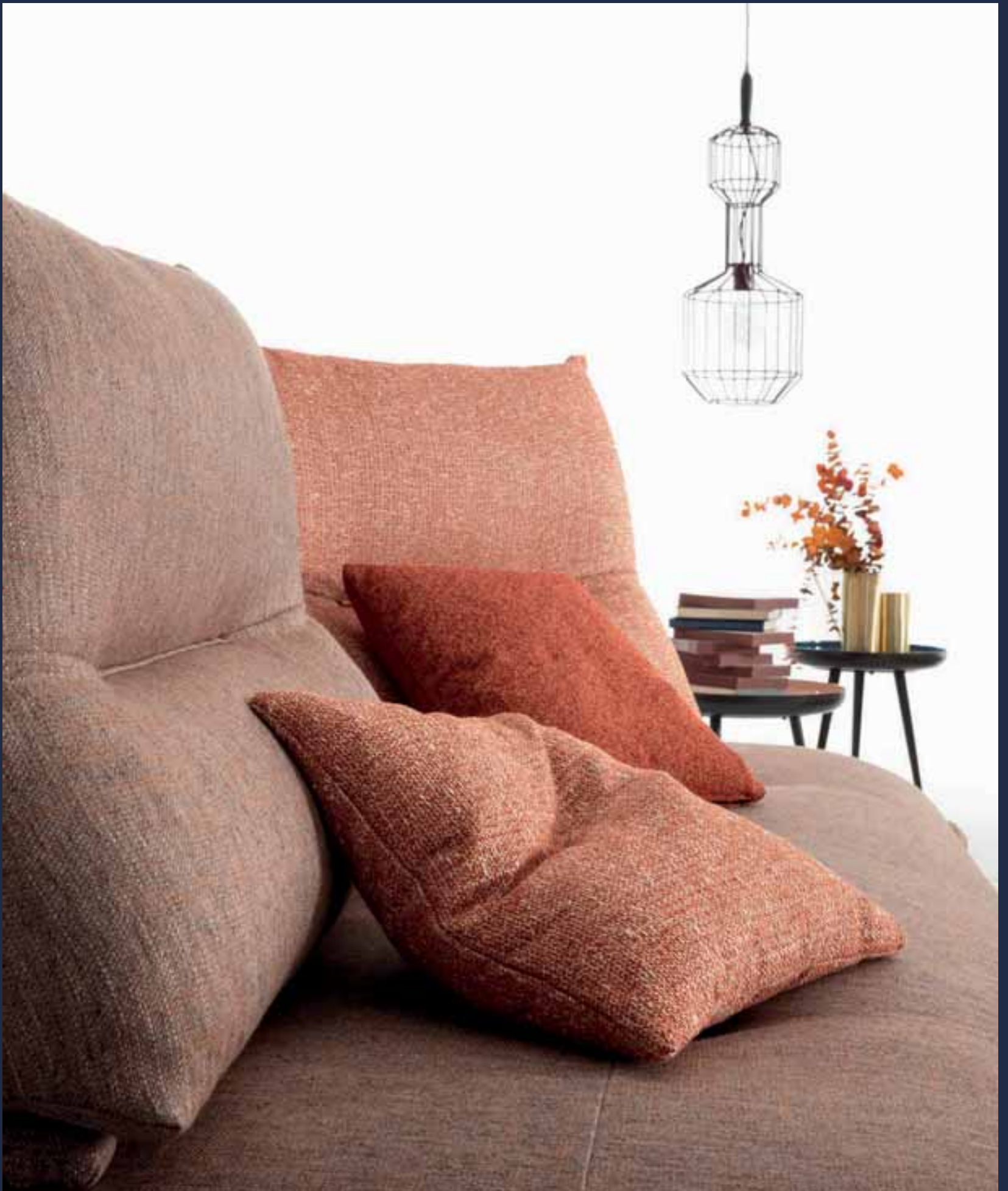

# GEMINI

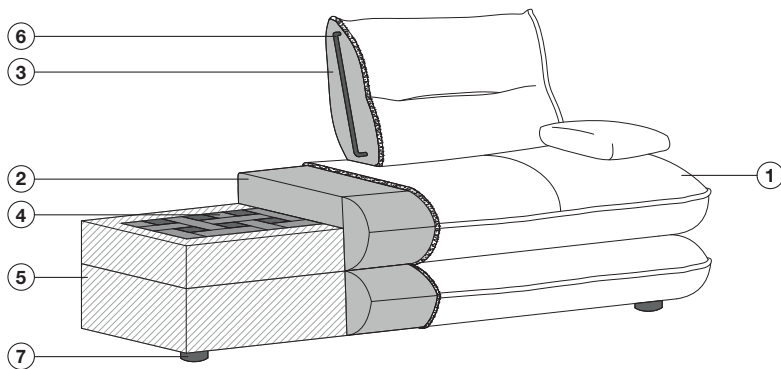

- 1 / Rivestimento
- 2 / Imbottitura seduta: poliuretano espanso HT 35 kg/m<sup>3</sup> ricoperto con resinato accoppiato
- 3 / Imbottitura schienale: poliuretano espanso a densità differenziata
- 4 / Sistema di molleggio: cinghie elastiche incrociate
- 5 / Struttura portante: legno massello e multistrato con parti in agglomerato
- 6 / Struttura schienale: scheletro in metallo
- 7 / Piedi in ABS antiscivolo

- 1 / Sofa covering
- 2 / Seat padding: expanded polyurethane HT 35 kg/m<sup>3</sup> covered with coupled wadding resin
- 3 / Backrest padding: expanded polyurethane in variable density
- 4 / Springing: suspension with elastic crossing belts
- 5 / Structure: solid wood and multilayer frame with parts in plywood and particle board
- 6 / Backrest structure: metal frame
- 7 / Antislip ABS feet

- 1 / Revêtement
- 2 / Rembourrage assise: polyuréthane expansé HT 35 Kg/m<sup>3</sup> recouvert en résiné couplé
- 3 / Rembourrage dossier: polyuréthane expansé multi-densité
- 4 / Système de suspension: sangles élastiques entrecroisées
- 5 / Structure portante: bois massif et panneaux agglomérés ou multicouche
- 6 / Structure dossier: support en métal
- 7 / Pieds ABS antidérapant



**Divani  
Sofas  
Canapés**

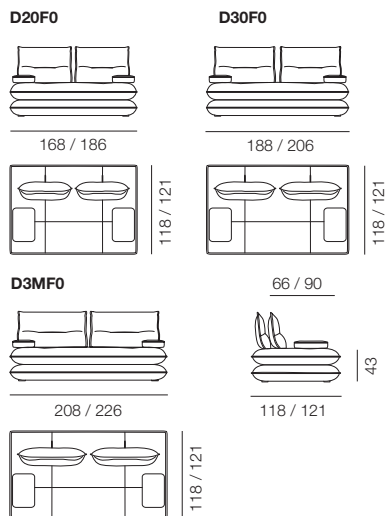

**Elementi centrali  
Central elements  
Banquettes**

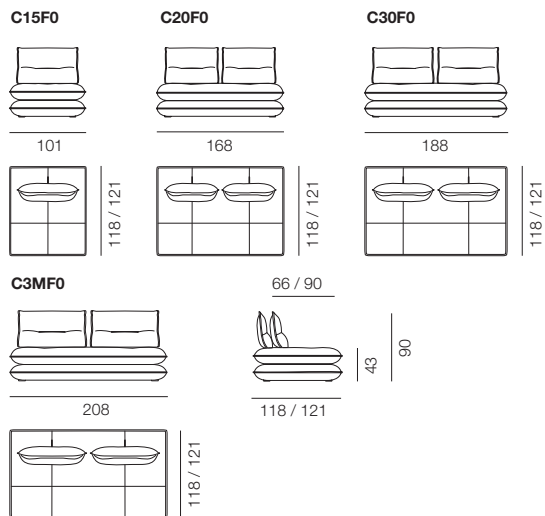

**Elementi terminali  
Terminal elements  
Batards**

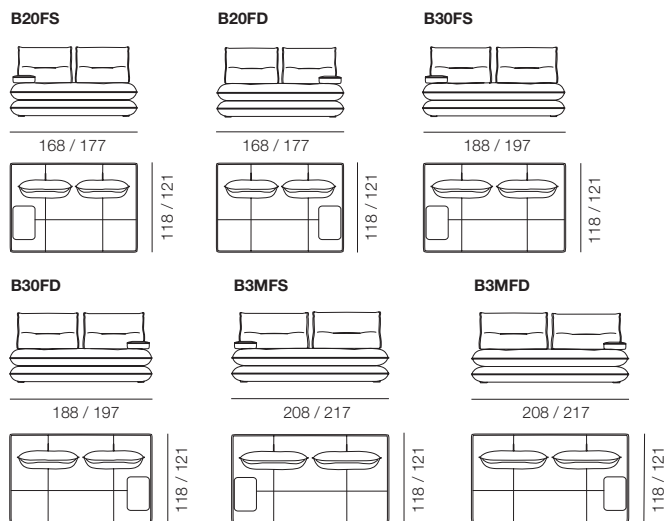

**Basi senza schienali  
Bases without backrests  
Banquettes sans dossiers**

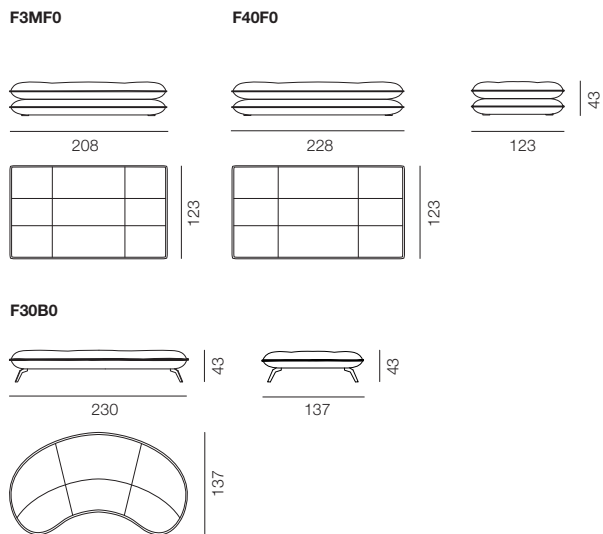

**Chaise longue  
Chaise longue  
Chaises longues**

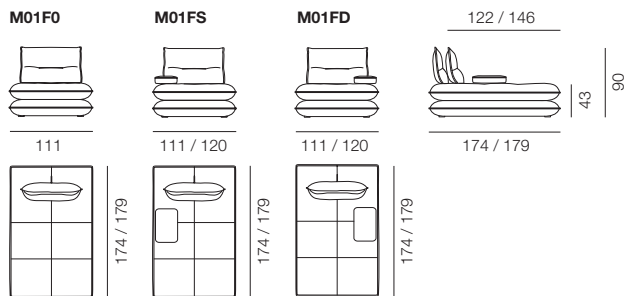

**Pouf  
Pouf  
Poufs**

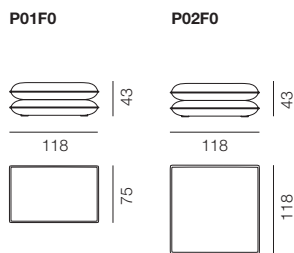

**Schienali liberi  
Removable backrests  
Dossiers amovibles**

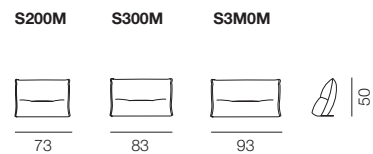



# LIBRA

designed by Andrea Arena

Una seduta extra-confortevole e un design moderno e particolare : è il divano Libra , protagonista della collezione Joyfull. Può infatti adattarsi a qualunque genere di spazio, con la sua seduta profonda sarà la vostra costante tentazione a fermarvi, a sedervi, a coricarvi e a godere della sua suadente comodità.

An extra-comfortable seat and a modern and particular design: it is the Libra sofa, the protagonist of the Joyfull collection. In fact, it can adapt to any kind of space, and with its deep seat it will be your constant temptation to stop, sit down, lie down and enjoy its persuasive comfort.

Un siège extra-confortable et un design moderne et particulier : c'est le canapé Libra, protagoniste de la collection Joyfull. En effet, il peut s'adapter à n'importe quel type d'espace, avec son assise profonde, le Libra sera votre tentation constante de vous arrêter, de vous asseoir, de vous allonger et de profiter de son confort persuasif.

— 1 Libra:

pelle cat.800 Seta 9025 razza / Piede Vito Titanio  
leather cat.800 Seta 9025 razza / Titanium Vito foot  
cuir cat.800 Seta 9025 razza / Pied Vito titanium

— 2 Libra:

pelle cat.800 Seta 9015 carrara / Piede Vito Titanio  
leather cat.800 Seta 9015 carrara / Titanium Vito foot  
cuir cat.800 Seta 9015 carrara / Pied Vito titanium

— 3 Libra:

pelle cat.800 Seta 9002 solidago /  
pelle cat.800 Seta 9015 carrara / Piede Vito Titanio  
leather cat.800 Seta 9002 solidago /  
leather cat.800 Seta 9015 carrara / Titanium Vito foot  
cuir cat.800 Seta 9002 solidago /  
cuir cat.800 Seta 9015 carrara / Pied Vito titanium





— 1 Libra:

pelle cat.800 Seta 9015 carrara / Piede Vito Titanio  
leather cat.800 Seta 9015 carrara / Titanium Vito foot  
cuir cat.800 Seta 9015 carrara / Pied Vito titanium

— 2 Libra:

tessuto Bazar col.22 / Piede Vito Titanio  
fabric Bazar col.22 / Titanium Vito foot  
tissu Bazar col.22 / Pied Vito titanium

— 3 Libra:

tessuto Bazar col.21 / Piede Vito Titanio  
fabric Bazar col.21 / Titanium Vito foot  
tissu Bazar col.21 / Pied Vito titanium

— 4 Libra:

pelle cat.800 Seta 9002 solidago /  
pelle cat.800 Seta 9015 carrara / Piede Vito Titanio  
leather cat.800 Seta 9002 solidago /  
leather cat.800 Seta 9015 carrara / Titanium Vito foot  
cuir cat.800 Seta 9002 solidago /  
cuir cat.800 Seta 9015 carrara / Pied Vito titanium











— **1 Libra:**  
tessuto Frida col.09 / Piede Jazz Titanio  
fabric Frida col.09 / Titanium Jazz foot  
tissu Frida col.09 / Pied Jazz titanium

— **2 Libra:**  
pelle cat.800 Seta 9015 carrara / Piede Jazz Titanio  
leather cat.800 Seta 9015 carrara / Titanium Jazz foot  
cuir cat.800 Seta 9015 carrara / Pied Jazz titanium

— **3 Dixi:**  
tessuto Frida col.06  
fabric Frida col.06  
tissu Frida col.06











— 1 Libra:

tessuto Frida col.09 / Piede Jazz Titanio  
fabric Frida col.09 / Titanium Jazz foot  
tissu Frida col.09 / Pied Jazz titanium

— 2 Libra:

pelle cat.800 Seta 9015 carrara / Piede Jazz Titanio  
leather cat.800 Seta 9015 carrara / Titanium Jazz foot  
cuir cat.800 Seta 9015 carrara / Pied Jazz titanium

— 3 Dixi:

tessuto Frida col.06  
fabric Frida col.06  
tissu Frida col.06



# LIBRA

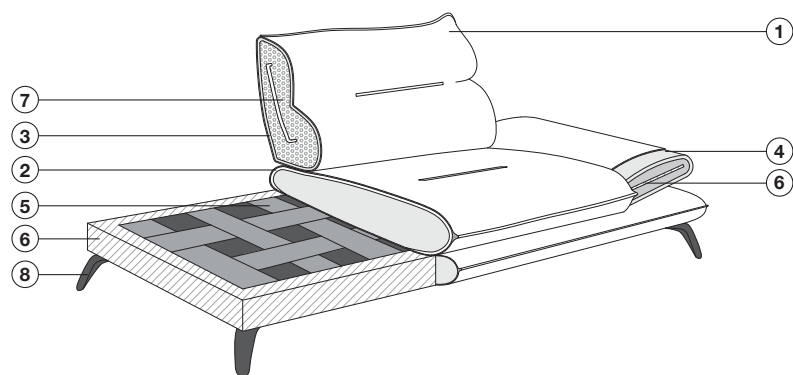

- 1 / Rivestimento
- 2 / Imbottitura seduta: poliuretano espanso HT 35 kg/m<sup>3</sup> ricoperto con resinato accoppiato
- 3 / Imbottitura schienale: poliuretano espanso SUPER SOFT ricoperto con resinato accoppiato
- 4 / Imbottitura bracciolo: poliuretano espanso ricoperto con resinato accoppiato
- 5 / Sistema di molleggio: cinghie elastiche incrociate
- 6 / Struttura portante: legno massello e multistrato con parti in agglomerato
- 7 / Struttura schienale: scheletro in metallo
- 8 / Piedi in metallo

- 1 / Sofa covering
- 2 / Seat padding: expanded polyurethane HT 35kg/m<sup>3</sup> covered with coupled wadding resin
- 3 / Backrest padding: expanded polyurethane SUPER SOFT covered with coupled wadding resin
- 4 / Armrest padding: expanded polyurethane covered with coupled wadding resin
- 5 / Springing: suspension with elastic crossing belts
- 6 / Structure: solid wood and multilayer frame with parts in plywood and particle board
- 7 / Backrest structure: metal frame
- 8 / Metal feet

## Finiture metallo Metal finishes Finitions métalliques



TITANIO

- 1 / Revêtement
- 2 / Rembourrage assise: polyuréthane expansé HT 35 Kg/m<sup>3</sup> recouvert en résiné couplé
- 3 / Rembourrage dossier: polyuréthane expansé SUPER SOFT recouvert en résiné couplé
- 4 / Rembourrage accoudoir: polyuréthane expansé recouvert en résiné couplé
- 5 / Système de suspension: sangles élastiques entrecroisées
- 6 / Structure portante: bois massif et panneaux agglomérés ou multicouche
- 7 / Structure dossier: support en métal
- 8 / Pieds en métal

**Centrale 1 posto**  
Central element 1 seater  
Chauffeuse 1 place

**C10F0**

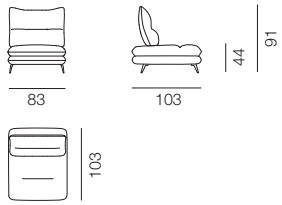

**Centrale 1 posto trapezio**  
Central element 1 seater trapezoid  
Chauffeuse trapèze 1 place

**C10T0**

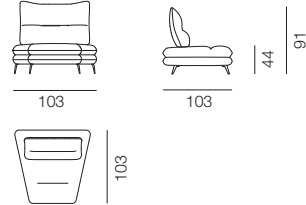

**Centrale 1 posto grande**  
Central element 1 seater big  
Chauffeuse 1 place grand

**C15F0**

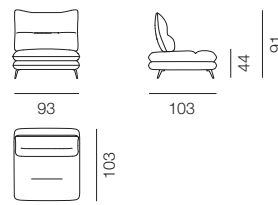

**Centrale 2 posti**  
Central element 2 seaters  
Banquette 2 places

**C20F0**

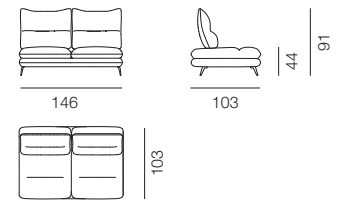

**Terminale 2 posti dx/sx**  
Terminal element 2 seaters right/left  
Batard 2 places droit/gauche

**B20FS**

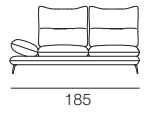

**B20FD**

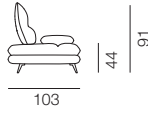
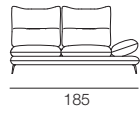

**Centrale 3 posti**  
Central element 3 seaters  
Banquette 3 places

**C30F0**

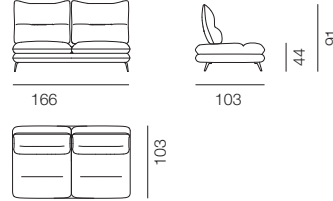

**Terminale 3 posti dx/sx**  
Terminal element 3 seater right/left  
Batard 3 places droit/gauche

**B30FS**

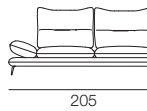

**B30FD**

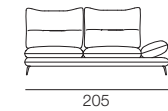

**Divano 2 posti**  
Sofa 2 seaters  
Canapé 2 places

**D20F0**

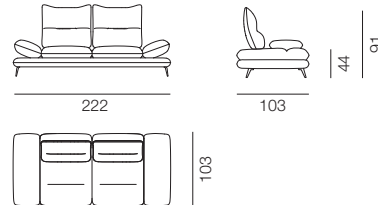

**Chaise longue**  
Chaise longue  
Chaise longue

**M01F0**

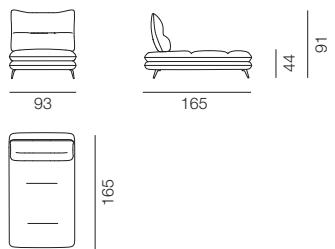

**Angolo**  
Corner  
Élément d'angle

**A01F0**

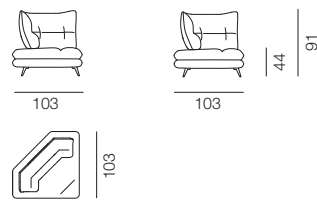

**Divano 3 posti**  
Sofa 3 seaters  
Canapé 3 places

**D30F0**

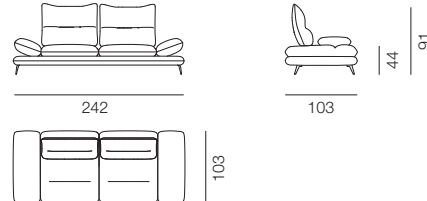

**Angolare dx/sx**  
Right/left corner element  
Elements d'angle droit/gauche

**M04FS**



**M04FD**

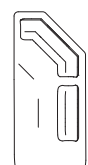
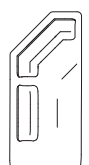

**Pouf quadrato**  
Squared pouf  
Pouf carré

**P02F0**

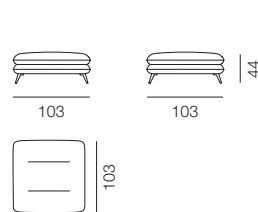

**Bracciolo**  
Armrest  
Accoudoir

**001B0**





# GARDENIA

designed by Andrea Arena

Minimalista ed informale, dedicato a chi ama la semplicità delle forme, ma allo stesso tempo ricerca un gusto "moderno", fatto di alta qualità combinata ad uno stile spigliato e lineare.

Minimalist and informal, dedicated to those who love the simplicity of shapes, but at the same time pursues a "modern" taste, made of high quality combined with a sharp and linear style.

Minimaliste et informel, dédié à ceux qui aiment la simplicité des formes, mais recherchent en même temps un goût « moderne », fait de haute qualité combiné à un style net et linéaire.



— **1 Gardenia:**  
tessuto Cinema col.57  
fabric Cinema col.57  
tissu Cinema col.57

— **2 Gardenia:**  
pelle cat.800 Seta 9019 ottanio  
leather cat.800 Seta 9019 ottanio  
cuir cat.800 Seta 9019 ottanio

— **3 Gardenia:**  
tessuto Cinema col.57  
fabric Cinema col.57  
tissu Cinema col.57

— **4 Dixi:**  
tessuto Frida col.06  
fabric Frida col.06  
tissu Frida col.06





2

3



— **1 Gardenia:**  
tessuto Cinema col.57  
fabric Cinema col.57  
tissu Cinema col.57

— **2 Gardenia:**  
pelle cat.800 Seta 9019 ottanio  
leather cat.800 Seta 9019 ottanio  
cuir cat.800 Seta 9019 ottanio

— **3 Gardenia:**  
tessuto Cinema col.57  
fabric Cinema col.57  
tissu Cinema col.57











# GARDENIA

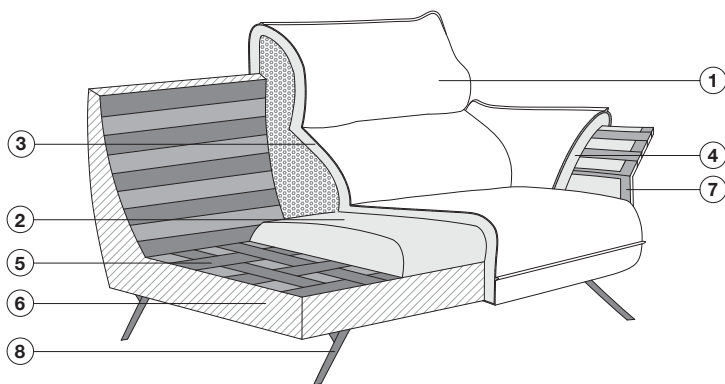

## Finiture metallo Metal finishes Finitions métalliques



55

1 / Rivestimento  
2 / Imbottitura seduta: poliuretano espanso HT 35 kg/m<sup>3</sup> ricoperto con poliuretano espanso SUPER SOFT  
3 / Imbottitura schienale: poliuretano espanso SUPER SOFT ricoperto con resinato accoppiato  
4 / Imbottitura bracciolo: poliuretano espanso ricoperto con resinato accoppiato  
5 / Sistema di molleggio: cinghie elastiche incrociate  
6 / Struttura portante: legno massello e multistrato con parti in agglomerato  
7 / Struttura bracciolo: metallo  
8 / Piedi in metallo

1 / Sofa covering  
2 / Seat padding: expanded polyurethane HT 35 kg/m<sup>3</sup> covered with resin wadding  
3 / Backrest padding: expanded polyurethane 22 kg/m<sup>3</sup> SUPER SOFT covered with resin wadding  
4 / Armrest padding: expanded polyurethane covered with coupled wadding resin  
5 / Springing: suspension with elastic crossing belts  
6 / Structure: solid wood and multilayer frame with parts in plywood and particle board  
7 / Armrest structure: metal  
8 / Metal feet

1 / Revêtement  
2 / Rembourrage assise: polyuréthane expansé HT 35 Kg/m<sup>3</sup> recouvert en polyuréthane expansé SUPER SOFT  
3 / Rembourrage dossier: polyuréthane expansé SUPER SOFT recouvert en résiné couplé  
4 / Rembourrage accoudoir: polyuréthane expansé recouvert en résiné couplé  
5 / Système de suspension: sangles élastiques entrecroisées  
6 / Structure portante: bois massif et panneaux agglomérés ou multicouche  
7 / Structure accoudoir: métal  
8 / Pieds en métal

**Divano 2 posti dx/sx**  
**Sofa 2 seaters right/left**  
**Batard 2 places droit/gauche**

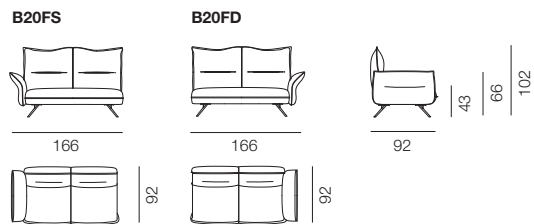

**Divano 3 posti maxi**  
**Sofa 3 seaters maxi**  
**Canapé 3 places maxi**

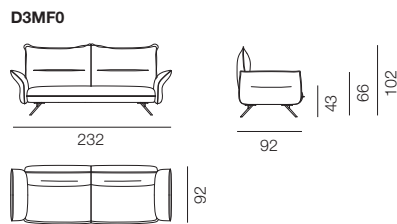

**Divano 3 posti dx/sx**  
**Sofa 3 seaters right/left**  
**Batard 3 places droit/gauche**

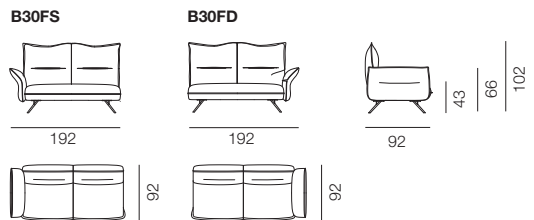

**Chaise longue**  
**Chaise longue**  
**Chaise longue**

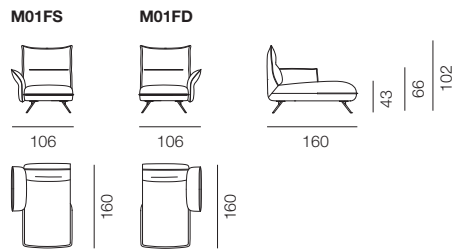

**Divano 3 posti maxi dx/sx**  
**Sofa 3 seaters maxi right/left**  
**Batard 3 places maxi droit/gauche**

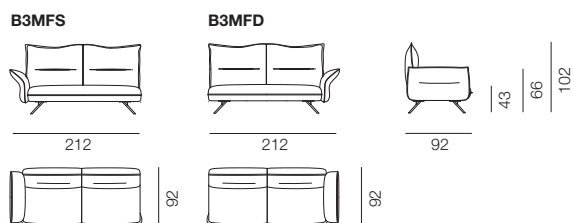

**Pouf rettangolare**  
**Rectangular pouf**  
**Pouf rectangulaire**

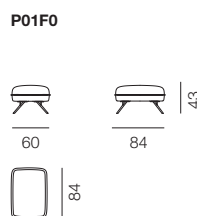

**Divano 2 posti**  
**Sofa 2 seaters**  
**Canapé 2 places**

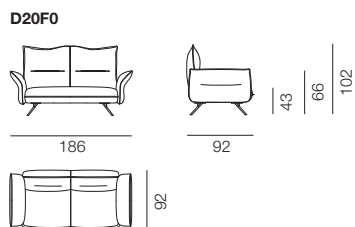

**Pouf quadrato**  
**Squared pouf**  
**Pouf carré**

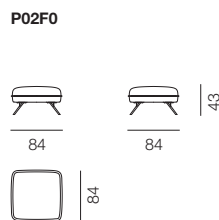

**Divano 3 posti**  
**Sofa 3 seaters**  
**Canapé 3 places**

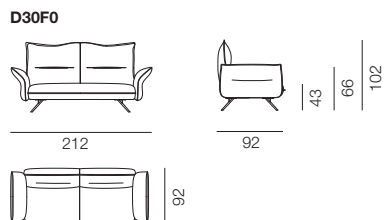



# WALLET

designed by Andrea Arena

Un divano che si modella sui desideri, per offrire personali interpretazioni di stile. L'architettura morbida apre i braccioli come ali, per lasciare i pensieri liberi di volare verso mondi rilassanti. Un design senza tempo in una duplice declinazione, per esplorare le molteplici dimensioni del comfort.

This sofa meets every desire to express your style. Its armrests open like wings to let your thoughts fly towards relaxing worlds. The two versions of its timeless design allow you to explore every dimension of comfort.

Un canapé qui prend forme en fonction des désirs de chacun afin d'offrir des interprétations personnelles de style. L'architecture souple ouvre les accoudoirs comme des ailes et ainsi laisse libre cours aux pensées de s'envoler vers des mondes plus relaxants. Un design hors du temps en une double déclinaison pour explorer les multiples dimensions du confort.



— 1 Wallet:

tessuto Cool col.600 / fettuccia cool.605 / metallo M310 antracite  
fabric Cool col.600 / piping cool.605 / Anthracite metal M310  
tissu Cool col.600 / passepoil cool.605 / métal M310 Anthracite

— 2 Wallet:

tessuto Cool col.600 / fettuccia cool.605 / metallo M310 antracite  
fabric Cool col.600 / piping cool.605 / Anthracite metal M310  
tissu Cool col.600 / passepoil W.605 / métal M310 Anthracite



1













— 1 Wallet:

tessuto Cool col.901 - fettuccia Leida col.63

fabric Cool col.901 - piping Leida col.63

tissu Cool col.901 - passepoil Leida col.63

①







# WALLET

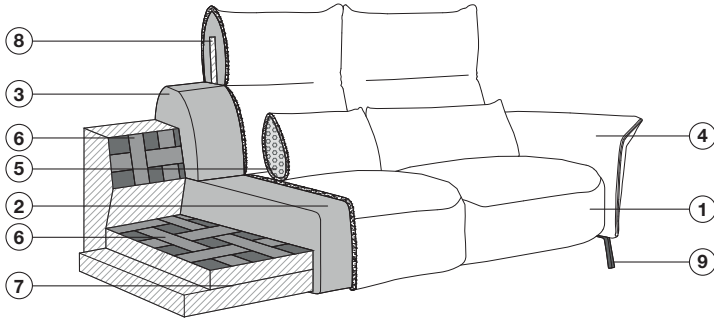
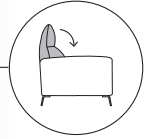

## Finiture metallo Metal finishes Finitions métalliques

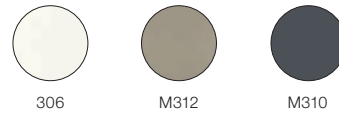

- 1 / Rivestimento
- 2 / Imbottitura seduta: poliuretano espanso HT 35 kg/m<sup>3</sup> ricoperto con resinato accoppiato
- 3 / Imbottitura schienale: poliuretano espanso a densità differenziata
- 4 / Imbottitura bracciolo: poliuretano espanso 30 kg/m<sup>3</sup>
- 5 / Imbottitura poggiatesta: piuma d'oca
- 6 / Sistema di molleggio: cinghie elastiche incrociate
- 7 / Struttura portante: legno massello e multistrato con parti in agglomerato
- 8 / Poggiatesta: scheletro in legno, imbottitura in poliuretano espanso
- 9 / Piedi in metallo

- 1 / Sofa covering
- 2 / Seat padding: expanded polyurethane HT 35 kg/m<sup>3</sup> covered with coupled wadding resin
- 3 / Backrest padding: expanded polyurethane in variable density
- 4 / Armrest padding: expanded polyurethane 30 kg/m<sup>3</sup>
- 5 / Loinrest padding: feather
- 6 / Springing: suspension with elastic crossing belts
- 7 / Structure: solid wood and multilayer frame with parts in plywood and particle board
- 8 / Headrest: wood frame and expanded polyurethane
- 9 / Metal feet

- 1 / Revêtement
- 2 / Rembourrage assise: polyuréthane expansé HT 35 Kg/m<sup>3</sup> recouvert en résiné couplé
- 3 / Rembourrage dossier: polyuréthane expansé multi-densité
- 4 / Rembourrage accoudoir: polyuréthane expansé 30 Kg/m<sup>3</sup>
- 5 / Rembourrage cale rein: plume d'oie
- 6 / Système de suspension: sangles élastiques entrecroisées
- 7 / Structure portante: bois massif et panneaux agglomérés ou multicouche
- 8 / Appuie-tête: structure en bois et rembourrage en polyuréthane expansé
- 9 / Pieds en métal

## Poltrona Armchair Fauteuil

D10F0

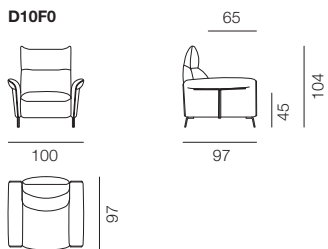

## Poltrona relax Recliner armchair Fauteuil relax

D10E0

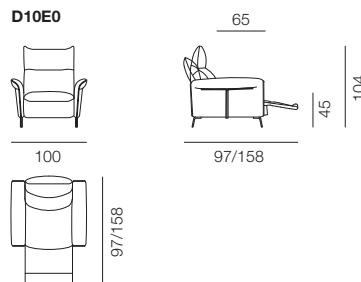

## Poggiatesta Lumbar support pillows Cale reins

S200P



S300P

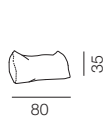

## Divani Sofas Canapés

D20F0

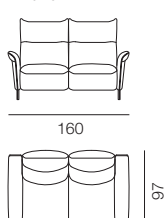

D30F0

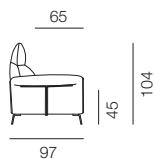
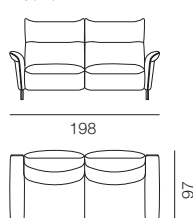

## Divani relax Recliner sofas Canapés relax

D20E2

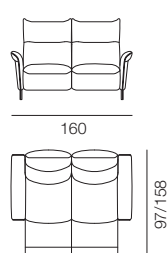

D30E2

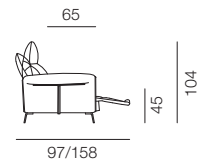
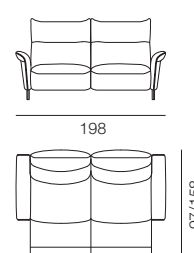



# COSY

designed by Andrea Arena

Cosy, linee moderne ma non estreme. Si integra facilmente con diversi stili di arredamento, da quello più lineare e minimal ad uno stile leggermente più classico.

Cosy, modern but not extreme lines. It easily integrates with different styles of furniture, from the most linear and minimal to a slightly more classic style.

Cosy, lignes modernes mais pas extrêmes. Il s'intègre facilement à différents styles de meubles, du plus linéaire et minimal à un style légèrement plus classique.



— 1 Cosy:

tessuto Cinema col.06 / pelle cat.800 Seta  
9211 Shadow / metallo m310 antracite  
fabric Cinema col.06 / leather cat.800 Seta  
9211 Shadow / Anthracite metal M310  
tissu Cinema col.06 / cuir cat.800 Seta  
9211 Shadow / métal M310 Anthracite

— 2 Cosy:

tessuto Petra col.21 / pelle cat.800 Seta  
9211 Shadow / metallo m310 antracite  
fabric Petra col.21 / leather cat.800 Seta  
9211 Shadow / Anthracite metal M310  
tissu Petra col.21 / cuir cat.800 Seta 9211  
Shadow / métal M310 Anthracite



2







# COSY

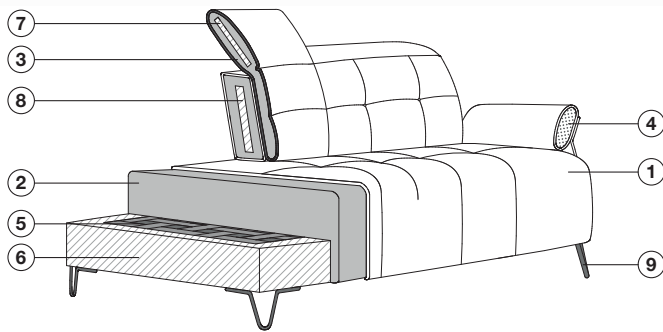

- 1 / Rivestimento
- 2 / Imbottitura seduta: poliuretano espanso HT 35 kg/m3 ricoperto con resinato accoppiato
- 3 / Imbottitura schienale: poliuretano espanso ricoperto con resinato accoppiato
- 4 / Imbottitura bracciolo: fibra di poliestere sfioccato e particelle di poliuretano espanso
- 5 / Sistema di molleggio: cinghie elastiche incrociate
- 6 / Struttura portante: legno massello e multistrato con parti in agglomerato
- 7 / Poggiatesta: scheletro in legno e imbottitura in poliuretano espanso
- 8 / Struttura schienale: scheletro in legno, imbottitura in poliuretano espanso
- 9 / Piedi in metallo

- 1 / Sofa covering
- 2 / Seat padding: expanded polyurethane HT 35 kg/m3 covered with coupled wadding resin
- 3 / Backrest padding: expanded polyurethane covered with coupled wadding resin
- 4 / Armrest padding: polyester fiber and expanded polyurethane particles
- 5 / Springing: suspension with elastic crossing belts
- 6 / Structure: solid wood and multilayer frame with parts in plywood and particle board
- 7 / Headrest: wood frame and expanded polyurethane
- 8 / Backrest structure: wood frame and expanded polyurethane
- 9 / Metal feet

## Finiture metallo Metal finishes Finitions métalliques

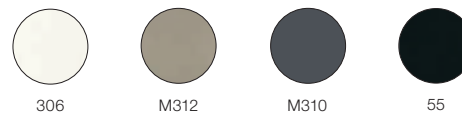

- 1 / Revêtement
- 2 / Rembourrage assise: polyuréthane expansé HT 35 Kg/m3 recouvert en résiné couplé
- 3 / Rembourrage dossier: polyuréthane expansé recouvert en résiné couplé
- 4 / Rembourrage accoudoir: fibre de polyester en flocons et particules de polyuréthane expansé
- 5 / Système de suspension: sangles élastiques entrecroisées
- 6 / Structure portante: bois massif et panneaux agglomérés ou multicouche
- 7 / Appuie-tête: structure en bois et rembourrage en polyuréthane expansé
- 8 / Structure dossier: Carcasse en bois et rembourrage en polyuréthane expansé
- 9 / Pieds en métal



**Divani  
Sofas  
Canapés**

**D20F0**

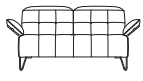

176

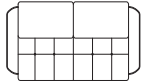

104/130

**D30F0**

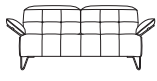

196

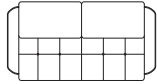

104/130

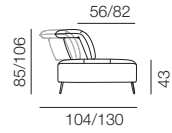

**D3MF0**

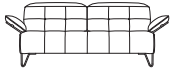

216

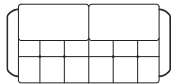

104/130

**Elementi terminali  
Terminal elements  
Batards**

**B20FS**

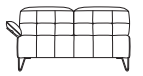

161

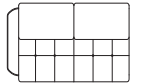

104/130

**B20FD**

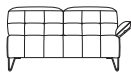

161

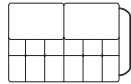

104/130

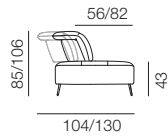

**B30FS**

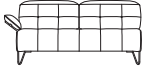

181

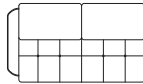

104/130

**B30FD**

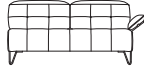

181

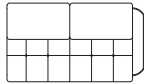

104/130

**B3MFS**

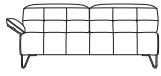

201

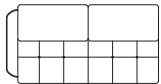

104/130

**B3MFD**

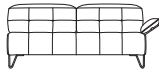

201

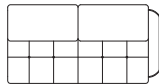

104/130

**Pouf  
Pouf  
Poufs**

**P01F0**



52



104

**P02F0**



104



104

**Chaise longue  
Chaise longue  
Chaises longues**

**M01F0**



93

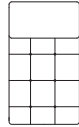

162/188

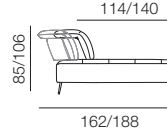

**M01FS**



108

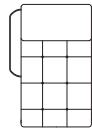

162/188

**M01FD**



108

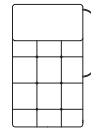

162/188

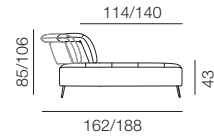

**Elementi centrali  
Central elements  
Banquettes**

**C20F0**

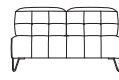

146

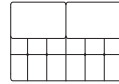

104/130

**C30F0**

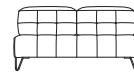

166

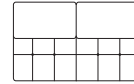

104/130

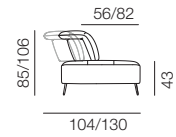

**C3MF0**

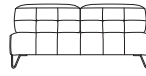

186

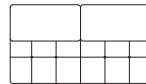

104/130



# LIBES

designed by Andrea Arena

Nato per accogliere e proteggere, Libes è il segno distintivo di una contemporaneità raffinata. La solidità dei volumi, studiati per regalare massimo piacere nel relax, come nella convivialità, si stempera nella base metallica creando un perfetto equilibrio di proporzioni.

Libes was designed for cosiness and protection. It's the distinctive expression of contemporary elegance. Its solid volumes ensure maximum pleasure in moments of relaxation and conviviality while the metal base creates the perfect balance between proportions.

Conçu pour accueillir et protéger, le Libes est le symbole distinctif d'une contemporanéité raffinée. La solidité des volumes, étudiés pour offrir un maximum de plaisir dans le relax, comme dans la convivialité, s'atténue à la base métallique ce qui crée ainsi un équilibre parfait de proportions.

— 1 Libes:  
pelle cat.800 Seta 9050 Alga / tessuto  
Sinfonia col.06  
leather cat.800 Seta 9050 Alga / fabric  
Sinfonia col.06  
cuir cat.800 Seta 9050 Alga / tissu  
Sinfonia col.06













**Finiture metallo**  
**Metal finishes**  
**Finitions métalliques**

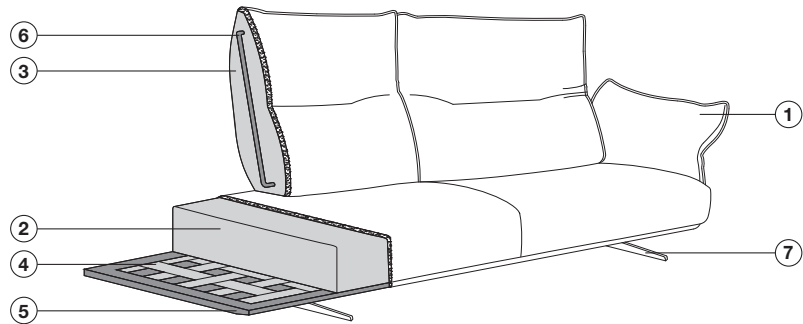
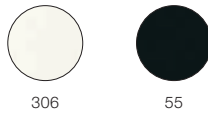

- 1 / Rivestimento
- 2 / Imbottitura seduta: poliuretano espanso HT 35 kg/m<sup>3</sup> ricoperto con resinato accoppiato
- 3 / Imbottitura schienale: poliuretano espanso
- 4 / Sistema di molleggio: cinghie elastiche incrociate
- 5 / Struttura portante: telaio in metallo
- 6 / Struttura schienale: scheletro in metallo
- 7 / Piedi in metallo

- 1 / Sofa covering
- 2 / Seat padding: expanded polyurethane HT 35 kg/m<sup>3</sup> covered with coupled wadding resin
- 3 / Backrest padding: expanded polyurethane
- 4 / Springing: suspension with elastic crossing belts
- 5 / Structure: metal frame
- 6 / Backrest structure: metal frame
- 7 / Metal feet

- 1 / Revêtement
- 2 / Rembourrage assise: polyuréthane expansé HT 35 Kg/m<sup>3</sup> recouvert en résiné couplé
- 3 / Rembourrage dossier: polyuréthane expansé
- 4 / Système de suspension: sangles élastiques entrecroisées
- 5 / Structure portante: cadre en métal
- 6 / Structure dossier: support en métal
- 7 / Pieds en métal



**Divani  
Sofas  
Canapés**

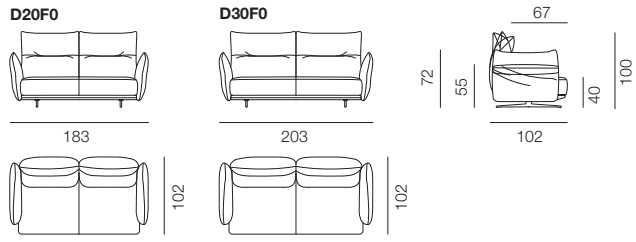

**Chaise longue  
Chaise longue  
Chaise longue**

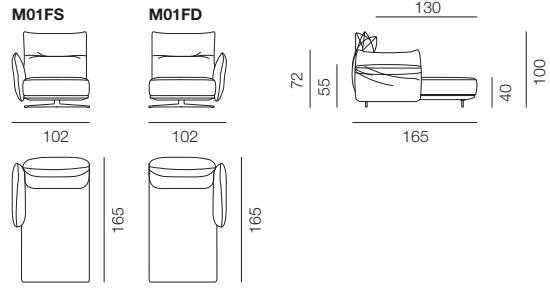

**Elementi terminali  
Terminal elements  
Batards**

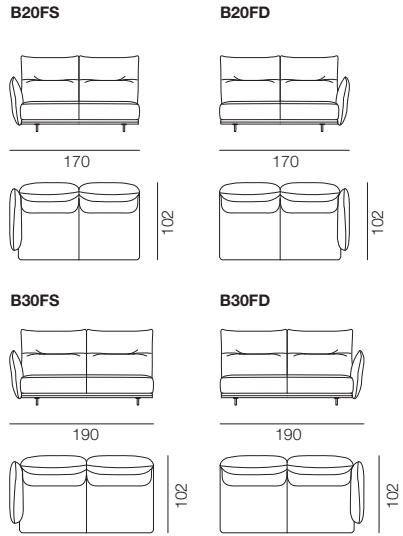

**Angolari  
Corner elements  
Eléments d'angle**

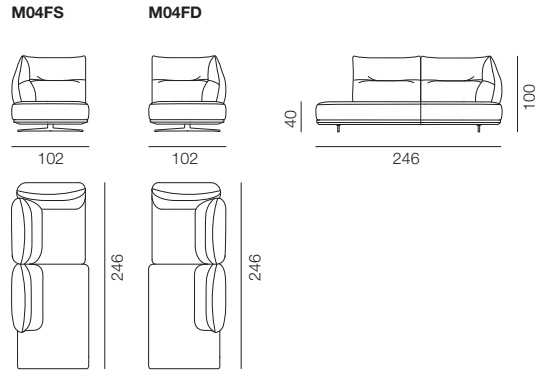

**Pouf  
Pouf  
Pouf**

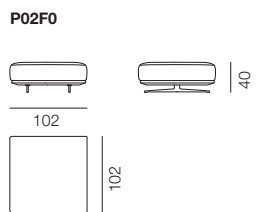





# DUMBLE

designed by Andrea Arena

Ospitale, trasformista, flessibile, Dumble con la sua concezione modulare, solletica la libertà compositiva.

Ogni dettaglio parla di stile e raffinatezza: il profilo bandella, il piede alto metallico, il design a singolo cuscinone suggeriscono leggerezza regalando un morbido approdo nel panorama del relax. La versione con il caratteristico design a "fagiolo" accende reminiscenze decò, impreziosendo di nuova fruibilità e nuova bellezza i ricordi di un tempo passato.

Hospitable, versatile and flexible, Dumble is the modular sofa that unleashes your creativity. Every detail oozes style and elegance. Its edge stitching, high metal feet, and single-cushion design turn it into a soft and relaxing haven. The version with the distinctive "bean" design hints at art deco features, giving new life to memories of the past.

Accueillant, transformiste, flexible, avec sa conception modulaire, le Dumble invite à la liberté de composition. Chaque détail parle de style et de finesse : la silhouette à bande, le haut pied métallique, le design du coussin unique rappellent la légèreté en offrant une approche en douceur dans le monde du relax. La version avec la forme caractéristique du « haricot » réveille des souvenirs déco, et enrichit d'une nouvelle facilité d'utilisation et d'une nouvelle beauté les souvenirs d'un temps passé.

— 1 Dumble:  
tessuto Frise col.401 / metallo g093 cromo  
fabric Frise col.401 / metal g093 chrome  
tissu Frise col.401 / métal g093 chromé













— 1 Dumble:  
tessuto Frise col.401 / tessuto Frise col.805 /  
metallo g093 cromo  
fabric Frise col.002 / fabric Frise col.805 /  
metal g093 chrome  
tissu Frise col.002 / tissu Frise col.805 /  
métal g093 chrome











# DUMBLE



**Finiture metallo**  
**Metal finishes**  
**Finitions métalliques**

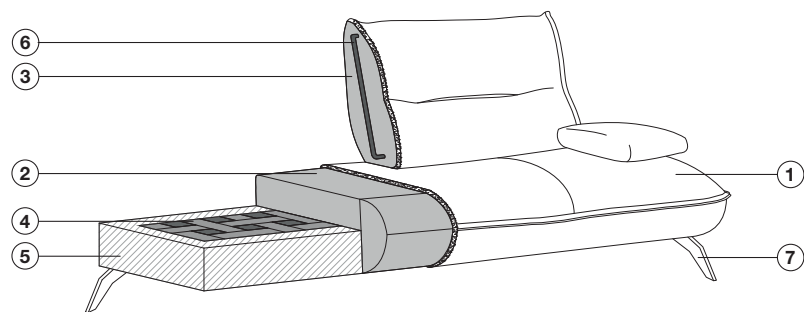
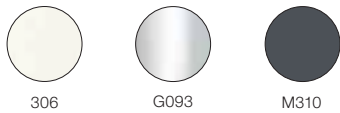

- 1 / Rivestimento
- 2 / Imbottitura seduta: poliuretano espanso HT 35 kg/m<sup>3</sup> ricoperto con resinato accoppiato
- 3 / Imbottitura schienale: poliuretano espanso a densità differenziata
- 4 / Sistema di molleggio: cinghie elastiche incrociate
- 5 / Struttura portante: legno massello e multistrato con parti in agglomerato
- 6 / Struttura schienale: scheletro in metallo
- 7 / Piedi in metallo

- 1 / Sofa covering
- 2 / Seat padding: expanded polyurethane HT 35 kg/m<sup>3</sup> covered with coupled wadding resin
- 3 / Backrest padding: expanded polyurethane in variable density
- 4 / Springing: suspension with elastic crossing belts
- 5 / Structure: solid wood and multilayer frame with parts in plywood and particle board
- 6 / Backrest structure: metal frame
- 7 / Metal feet

- 1 / Revêtement
- 2 / Rembourrage assise: polyuréthane expansé HT 35 Kg/m<sup>3</sup> recouvert en résiné couplé
- 3 / Rembourrage dossiers: polyuréthane expansé multi-densité
- 4 / Système de suspension: sangles élastiques entrecroisées
- 5 / Structure portante: bois massif et panneaux agglomérés ou multicouche
- 6 / Structure dossier: support métal
- 7 / Pieds en métal





**Divani  
Sofas  
Canapés**

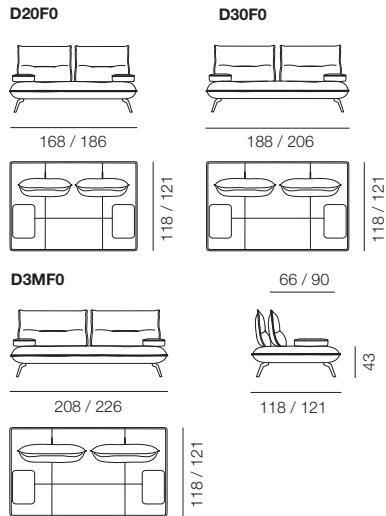

**Elementi centrali  
Central elements  
Chauffeuse et banquettes**

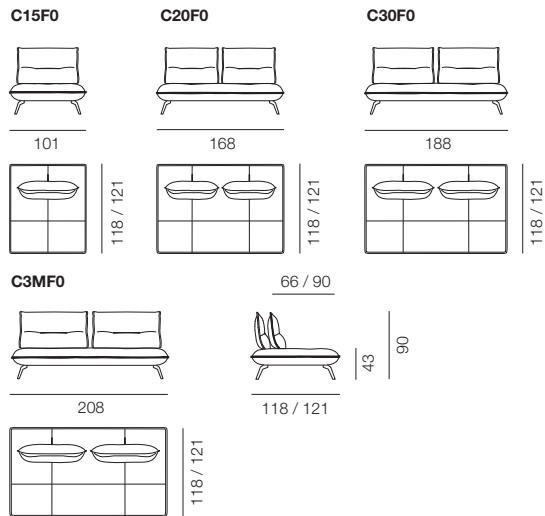

**Elementi terminali  
Terminal elements  
Batards**

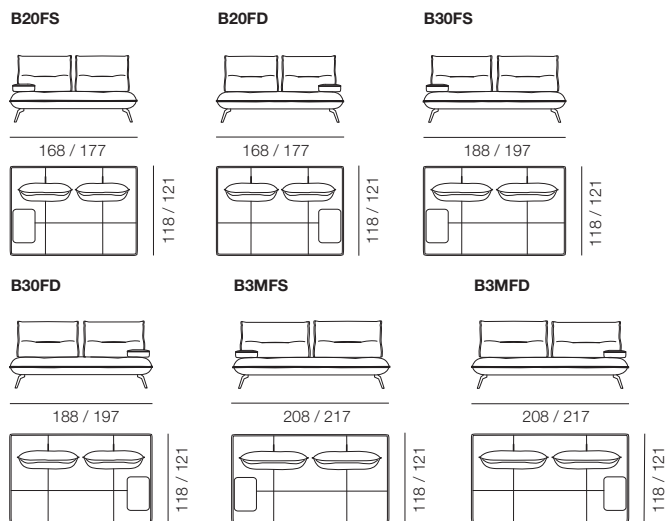

**Basi senza schienali  
Bases without backrests  
Banquettes sans dossiers**

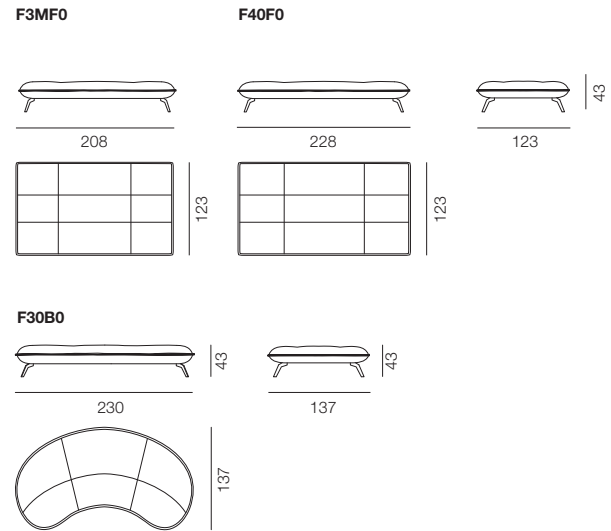

**Chaise longue  
Chaise longue  
Chaises longues**

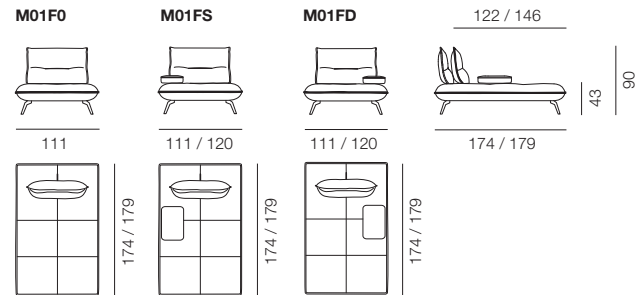

**Pouf  
Pouf  
Poufs**

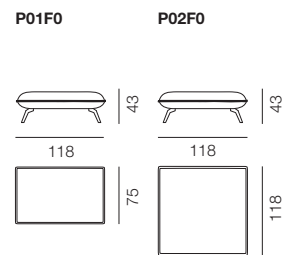

**Schienali liberi  
Removable backrests  
Dossiers amovibles**

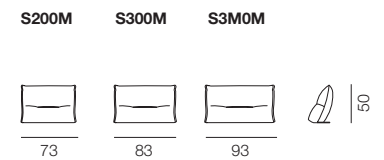



# FLUFFY COMFY

96  
Albatros



108  
Jinga



118  
Sambo



126  
Yume



Forme arrotondate ed avvolgenti per un nuovo livello di comodità.  
Reinterpretare le forme vestendole di materia e colore.

Rounded and enveloping shapes for a new level of comfort.  
Reinterpreting shapes by dressing them in material and color.

Des formes arrondies et enveloppantes pour un nouveau  
niveau de confort. Réinterpréter les formes en les habillant  
de matière et de couleur.



# ALBATROS

designed by Andrea Arena

Le linee del divano Albatros sono dotate di un'inconfondibile personalità. Destinato ad assumere un ruolo da protagonista all'interno di qualsiasi spazio, conferisce all'ambiente uno stile originale, moderno e sofisticato.

Albatros sofa's lines have an unmistakable personality. Intended to take on a leading role in any space, it gives to the environment an original, modern and sophisticated style.

Albatros est un canapé avec une personnalité incomparable et est certainement destiné à jouer un rôle de premier plan dans n'importe quel espace – dans votre salon ou dans des espaces publics - auquel il donne un style original et une note décorative moderne et sophistiquée



— **1 Albatros:**  
tessuto Fervor col.14 / fettuccia GrosGrain col 86 corallo  
fabric Fervor col.14 / piping GrosGrain col 86 corallo  
tissu Fervor col.14 / passepoil GrosGrain col 86 corallo

— **2 Albatros:**  
tessuto Fervor col.03 / fettuccia GrosGrain col 72 mandarino  
fabric Fervor col.03 / piping GrosGrain col 72 mandarino  
tissu Fervor col.03 / passepoil GrosGrain col 72 mandarino



①











— 1 Albatros:

tessuto Frise col.101 / fettuccia GrosGrain col.36 burro  
fabric Frise col.101 / piping GrosGrain col.36 burro  
tissu Frise col.101 / passepoil GrosGrain col.36 burro

— 2 Albatros:

tessuto Fervor col.03 / fettuccia GrosGrain col 72 mandarino  
fabric Fervor col.03 / piping GrosGrain col 72 mandarino  
tissu Fervor col.03 / passepoil GrosGrain col 72 mandarino











# ALBATROS

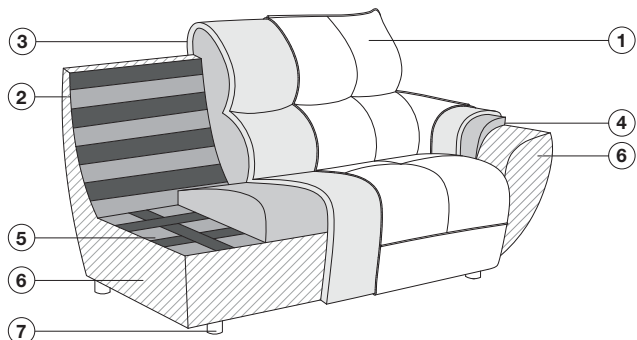

1 / Rivestimento

2 / Imbottitura seduta: poliuretano espanso HT 35 kg/m<sup>3</sup> ricoperto con poliuretano espanso SUPER SOFT

3 / Imbottitura schienale: poliuretano espanso ricoperto con poliuretano espanso SUPER SOFT

4 / Imbottitura bracciolo: poliuretano espanso 30 kg/m<sup>3</sup> ricoperto poliuretano espanso SUPER SOFT

5 / Sistema di molleggio: cinghie elastiche incrociate

6 / Struttura portante: legno massello e multistrato con parti in agglomerato

7 / Piedi in ABS

1 / Sofa covering

2 / Seat padding: expanded polyurethane HT 35 Kg/m<sup>3</sup> covered with expanded polyurethane SUPER SOFT

3 / Backrest padding: expanded polyurethane in variable density

4 / Backrest padding: expanded polyurethane in variable density

5 / Springing: suspension with elastic crossing belts

6 / Structure: solid wood and multilayer frame with parts in plywood and particle board

7 / ABS feet

1 / Revêtement

2 / Rembourrage assise: polyuréthane expansé HT 35 Kg/m<sup>3</sup> recouvert en polyuréthane expansé SUPER SOFT

3 / Rembourrage dossier: polyuréthane expansé recouvert en polyuréthane expansé SUPER SOFT

4 / Rembourrage accoudoir: polyuréthane expansé 30 kg/m<sup>3</sup> recouvert en polyuréthane expansé SUPER SOFT

5 / Système de suspension: sangles élastiques entrecroisées

6 / Structure portante: bois massif et panneaux agglomérés ou multicouche

7 / Pieds ABS

**Angolo  
Corner  
Angle**

**A01F0**

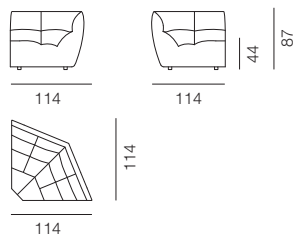

**Divano 2 posti  
Sofa 2 seaters  
Canapé 2 places**

**P01F0**

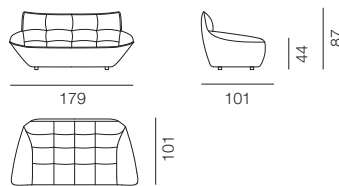

**Terminale 2 posti dx/sx  
Terminal elements 2 seaters right/left  
Batard 2 places droit/gauche**

**B20FS**

**B20FD**

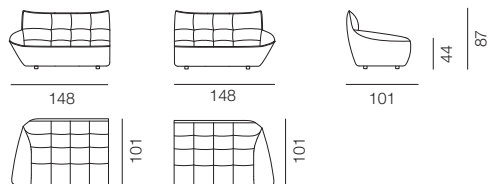

**Divano 3 posti  
Sofa 3 seaters  
Canapé 3 places**

**D30F0**

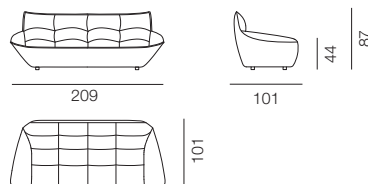

**Terminale 3 posti dx/sx  
Terminal elements 3 seaters right/left  
Batard 3 places droit/gauche**

**B30FS**

**B30FD**

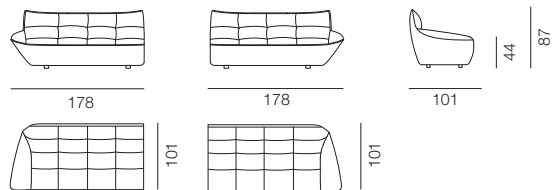

**Divano 3 posti maxi  
Sofa 3 seaters maxi  
Canapé 3 places maxi**

**D3MF0**

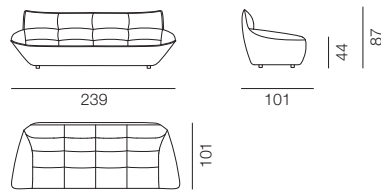

**Terminale 3 posti maxi dx/sx  
Terminal elements 3 seaters maxi right/left  
Batard 3 places maxi droit/gauche**

**B30FS**

**B30FD**

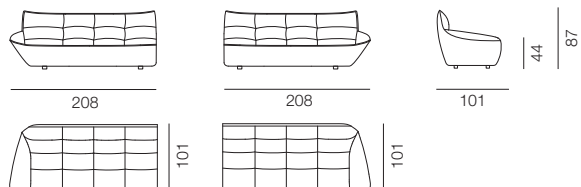

**Poltrona  
Armchair  
Fauteuil**

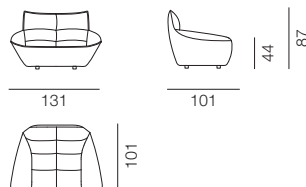





# JINGA

designed by Andrea Arena

Jinga, comodo e versatile, casual ma soprattutto funzionale, “fluttua” nella stanza portando in una dimensione di comfort e relax. Caratterizzato da uno spirito vintage e casual è la giusta soluzione sia per ambienti domestici che per spazi pubblici.

Jinga, comfortable and versatile, casual but above all functional, “floats” in the room bringing in a dimension of comfort and relaxation. Characterized by a vintage and casual spirit, it is the right solution for both domestic and public spaces.

Confortable et polyvalent, décontracté mais surtout fonctionnel, le Jinga « flotte » dans la pièce apportant une nouvelle dimension de confort et de détente. Caractérisé par un esprit vintage et décontracté, c’est la solution idéale pour les espaces domestiques et publics.

— **1 Jinga:**  
tessuto Bijou col.408  
fabric Bijou col.408  
tissu Bijou col.408

— **2 Jinga:**  
tessuto Bijou col.304  
fabric Bijou col.304  
tissu Bijou col.304

— **3 Jinga:**  
tessuto Bijou col.600  
fabric Bijou col.600  
tissu Bijou col.600

— **4 Jinga:**  
tessuto Bijou col.001  
fabric Bijou col.001  
tissu Bijou col.001

— **5 Gea:**  
tessuto Leida col.49 / tessuto Frise col.402  
fabric Leida col.49 / fabric Frise col.402  
tissu Leida col.49 / tissu Frise col.402















— **1 Jinga:**  
tessuto Bijou col.705  
fabric Bijou col.705  
tissu Bijou col.705

— **2 Jinga:**  
tessuto Bijou col.304  
fabric Bijou col.304  
tissu Bijou col.304

— **3 Jinga:**  
tessuto Bijou col.001  
fabric Bijou col.001  
tissu Bijou col.001



# JINGA

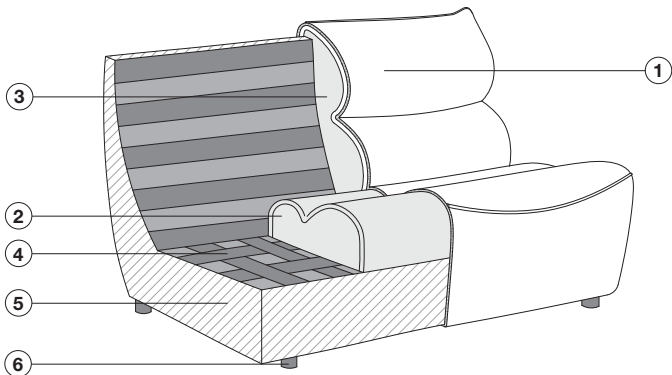
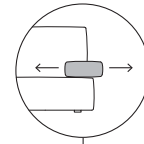

**1 / Rivestimento**  
**2 / Imbottitura seduta:** poliuretano espanso HT 35 kg/m<sup>3</sup> ricoperto con resinato accoppiato  
**3 / Imbottitura schienale:** poliuretano espanso ricoperto con resinato accoppiato  
**4 / Sistema di molleggio:** cinghie elastiche incrociate  
**5 / Struttura portante:** legno massello e multistrato con parti in agglomerato  
**6 / Piedi in ABS** antiscivolo

**1 / Sofa covering**  
**2 / Seat padding:** expanded polyurethane HT 35 kg/m<sup>3</sup> covered with coupled wadding resin  
**3 / Backrest padding:** expanded polyurethane covered with coupled wadding resin  
**4 / Springing:** suspension with elastic crossing belts  
**5 / Structure:** solid wood and multilayer frame with parts in plywood and particle board  
**6 / Antislip ABS feet**

**1 / Revêtement**  
**2 / Rembourrage assise:** polyuréthane expansé HT 35 Kg/m<sup>3</sup> recouvert en résiné couplé  
**3 / Rembourrage dossier:** polyuréthane expansé recouvert en résiné couplé  
**4 / Système de suspension:** sangles élastiques entrecroisées  
**5 / Structure portante:** bois massif et panneaux agglomérés ou multicouche  
**6 / Pieds ABS** antidérapant



**Angolo  
Corner  
Angle**

**A01F0**

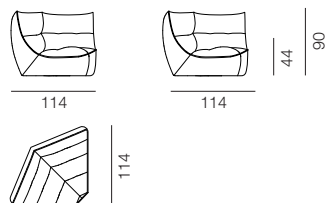

**Centrale 1 posto  
Central 1 seater  
Chauffeuse 1 place**

**C10F0**

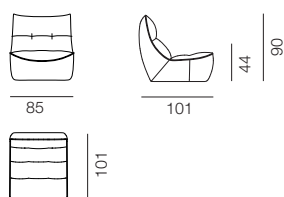

**Centrale 3 posti  
Central 3 seaters  
Banquette 3 places**

**C30F0**

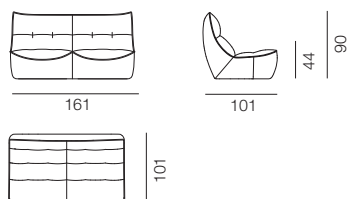

**Chaise longue  
Chaise longue  
Chaise longue**

**M01F0**

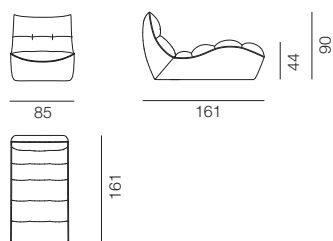

**Pouf trapezio  
Trapeze pouf  
Pouf trapèze**

**P08F0**

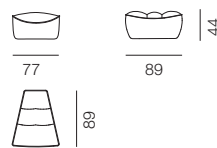

**Pouf rettangolare  
Rectangular pouf  
Pouf rectangulaire**

**P01F0**

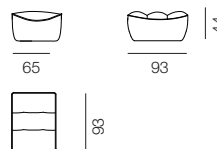

**Pouf quadrato  
Squared pouf  
Pouf carré**

**P02F0**

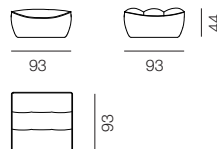

**Bracciolo  
Armrest  
Accoudoir**

**001B0**

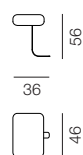





# SAMBO

designed by Andrea Arena

Modulare, per esplorare ogni possibilità; profondo e avvolgente, per diventare rifugio accogliente; componibile all'infinito, per delineare le forme della convivialità. Sambo è stato studiato per suggerire il calore di un'esclusiva alcova domestica. Ogni dettaglio rivela un'anima raffinata: l'angolo posteriore a trapezio, la morbidezza dei cuscini, il comfort delle sedute e il profilo della struttura definiscono affascinanti geometrie di vita.

A sofa that explores infinite possibilities: deep and cosy to provide warm shelter and modular to create infinite configurations and adapt to all the forms of conviviality. Sambo is designed to express the warmth of an exclusive domestic haven. Every detail reveals a sophisticated touch. Its trapezoidal backrest, soft cushions, comfortable seats, and the structure profile outline fascinating shapes.

Moduler, pour explorer chaque possibilité ; profond et envoûtant, il devient un refuge accueillant ; modulable à l'infini, pour mettre en évidence les formes de la convivialité. Le modèle Sambo a été étudié pour suggérer la chaleur que seule une alcôve domestique peut avoir. Chaque détail révèle une âme raffinée : l'angle postérieur à trapèze, la souplesse des coussins, le confort des assises et le profil de la structure définissent des géométries de vie fascinantes.

— **1 Sambo:**  
tessuto Frise col.610 / fettuccia Frise col.400/401  
fabric Frise col.610 / piping Frise col.400/401  
tissu Frise col.610 / passepoil Frise col.400/401

— **2 Celine:**  
tessuto Leida col.49 / fettuccia Leida col.14  
fabric Leida col.49 / piping Leida col.14  
tissu Leida col.49 / passepoil Leida col.14











# SAMBO

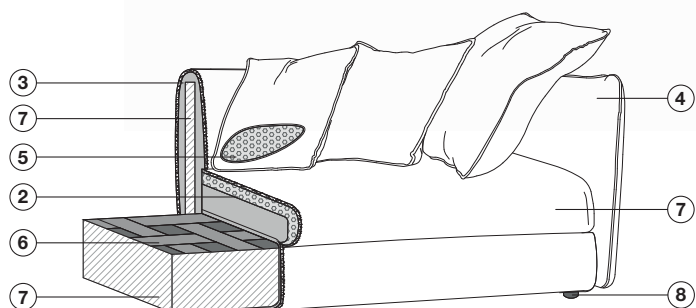

- 1 / Rivestimento
- 2 / Imbottitura seduta: poliuretano espanso e piuma d'oca
- 3 / Imbottitura schienale: poliuretano espanso
- 4 / Imbottitura bracciolo: poliuretano espanso 30 kg/m<sup>3</sup>
- 5 / Imbottitura cuscini: piuma d'oca
- 6 / Sistema di molleggio: cinghie elastiche incrociate
- 7 / Struttura portante: legno massello e multistrato con parti in agglomerato
- 8 / Piedi in ABS antiscivolo

- 1 / Sofa covering
- 2 / Seat padding: expanded polyurethane and feather
- 3 / Backrest padding: expanded polyurethane
- 4 / Armrest padding: expanded polyurethane 30 kg/m<sup>3</sup>
- 5 / Pillow padding: feather
- 6 / Springing: suspension with elastic crossing belts
- 7 / Structure: solid wood and multilayer frame with parts in plywood and particle board
- 8 / Antislip ABS feet

- 1 / Revêtement
- 2 / Rembourrage assise: polyuréthane expansé et plume d'oie
- 3 / Rembourrage dossier: polyuréthane expansé
- 4 / Rembourrage accoudoir: polyuréthane expansé 30 kg/m<sup>3</sup>
- 5 / Rembourrage coussins: plume d'oie
- 6 / Système de suspension: sangles élastiques entrecroisées
- 7 / Structure portante: bois massif et panneaux agglomérés ou multicouche
- 8 / Pieds ABS antidérapant

**Divani  
Sofas  
Canapés**

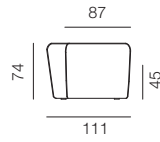
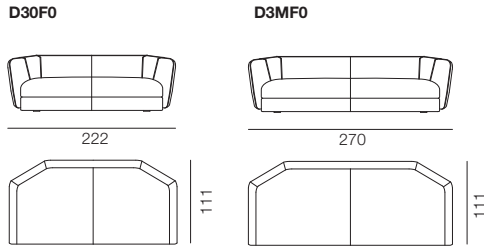

**Angolo  
Corner  
Angle**

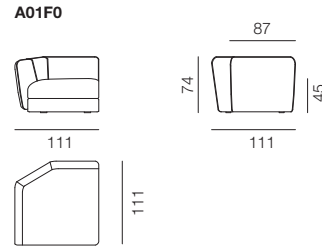

**Elemento centrale  
Central element  
Chauffeuse**

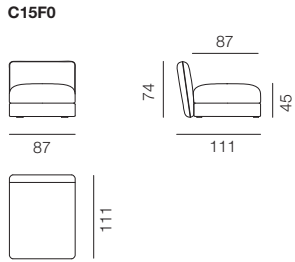

**Pouf  
Pouf  
Poufs**

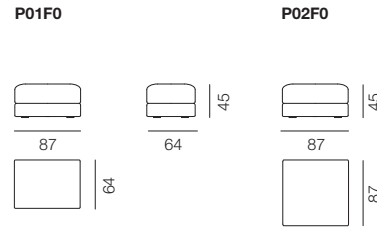

**Elementi terminali  
Terminal elements  
Batards**

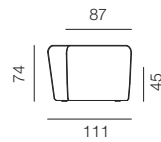
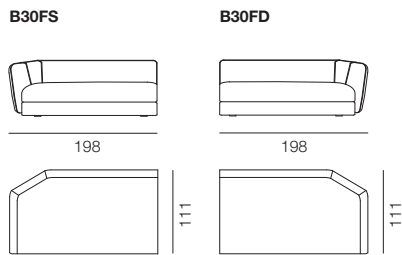

**Chaise longue  
Chaise longue  
Chaise longue**

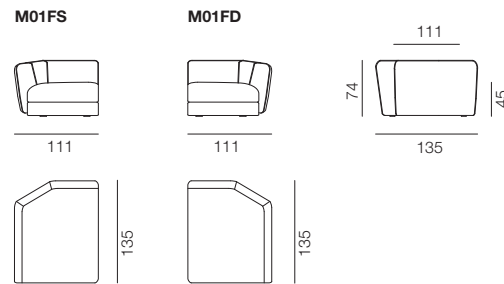

**Cuscini decorativi  
Decorative pillows  
Coussins déco**

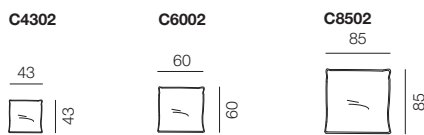

**Schienali  
Backrests  
Dossiers**

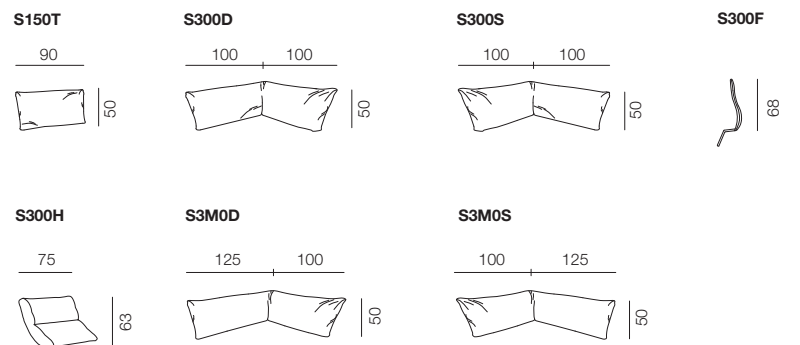



# YUME

designed by Andrea Arena

Yume è composto da un sistema di moduli di diverse dimensioni, tra loro combinabili per dar vita a molteplici configurazioni. Soffici cuscini che definiscono lo schienale, lasciando così all'utilizzatore libertà di interpretazione in base alle proprie esigenze.

Yume is composed of a system of modules of different sizes, which can be combined to create multiple configurations. Soft cushions that define the backrest, thus leaving the user freedom of interpretation according to their needs.

Yume est composé d'un système de modules de différentes tailles, qui peuvent être combinés pour créer plusieurs configurations. Coussins moelleux qui définissent le dossier, laissant ainsi à l'utilisateur une liberté d'interprétation en fonction des propres besoins.



— 1 Yume:  
tessuto Fervor col.11 / tessuto Bazar col.17  
fabric Fervor col.11 / fabric Bazar col.17  
tissu Fervor col.11 / tissu Bazar col.17















— 1 Yume:  
tessuto Fervor col.01 / tessuto Bazar col.11  
fabric Fervor col.01 / fabric Bazar col.11  
tissu Fervor col.01 / tissu Bazar col.11



# YUME

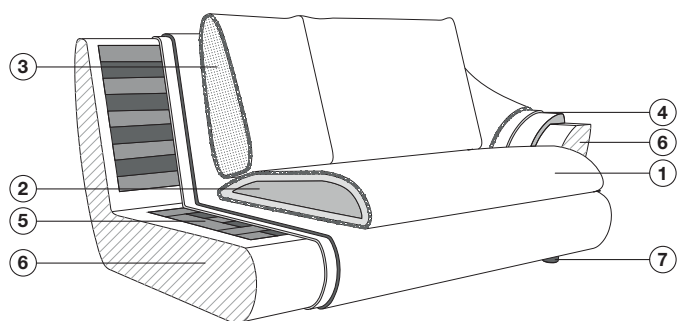

**1 / Rivestimento**  
**2 / Imbottitura seduta:** poliuretano espanso HT 35 kg/m<sup>3</sup> ricoperto con resinato accoppiato  
**3 / Imbottitura schienale:** poliuretano espanso a densità differenziata  
**4 / Sistema di molleggio:** cinghie elastiche incrociate  
**5 / Struttura portante:** legno massello e multistrato con parti in agglomerato  
**6 / Struttura schienale:** scheletro in metallo  
**7 / Piedi in ABS** antiscivolo

**1 / Sofa covering**  
**2 / Seat padding:** expanded polyurethane HT 35 kg/m<sup>3</sup> covered with coupled wadding resin  
**3 / Backrest padding:** expanded polyurethane in variable density  
**4 / Springing:** suspension with elastic crossing belts  
**5 / Structure:** solid wood and multilayer frame with parts in plywood and particle board  
**6 / Backrest structure:** metal frame  
**7 / Antislip ABS feet**

**1 / Revêtement**  
**2 / Rembourrage assise:** polyuréthane expansé HT 35 Kg/m<sup>3</sup> recouvert en résiné couplé  
**3 / Rembourrage dossier:** polyuréthane expansé multi-densité  
**4 / Système de suspension:** sangles élastiques entrecroisées  
**5 / Structure portante:** bois massif et panneaux agglomérés ou multicouche  
**6 / Structure dossier:** support en métal  
**7 / Pieds ABS** antidérapant

**Divani  
Sofas  
Canapés**

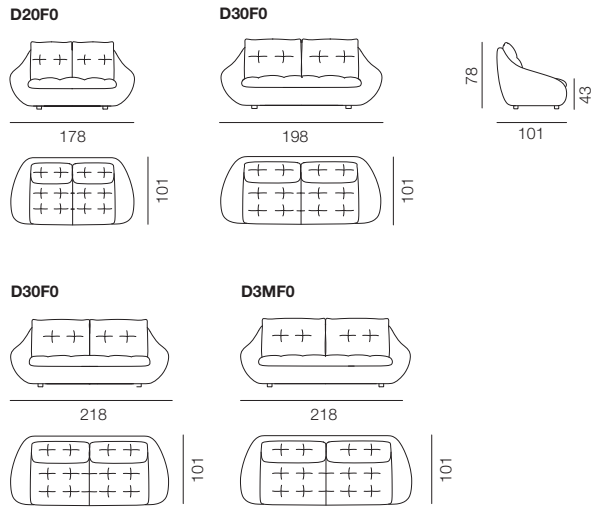

**Elementi terminali  
Terminal elements  
Batards**

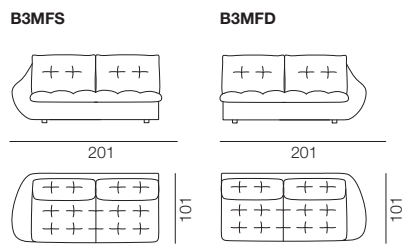
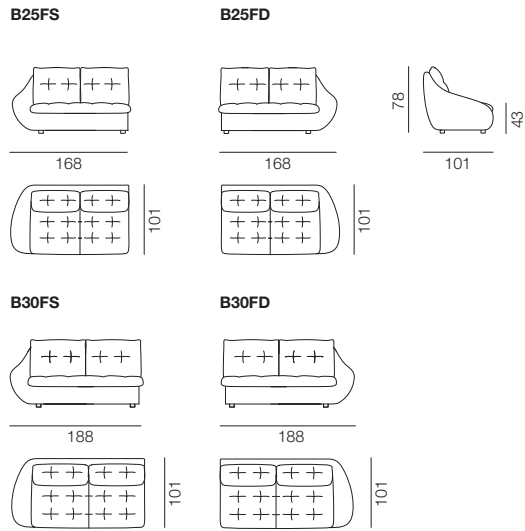

**Pouf  
Pouf  
Poufs**

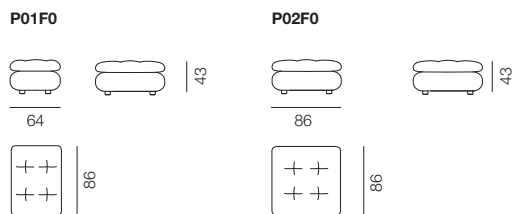

**Chaise longue  
Chaise longue  
Chaise longue**

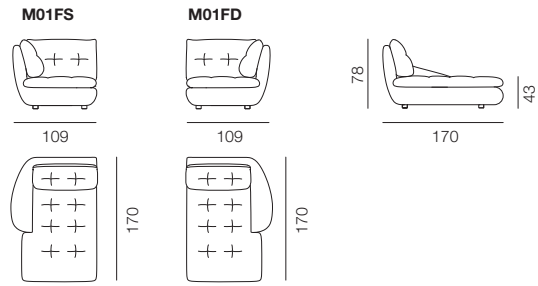

**Angolo  
Corner  
Angle**

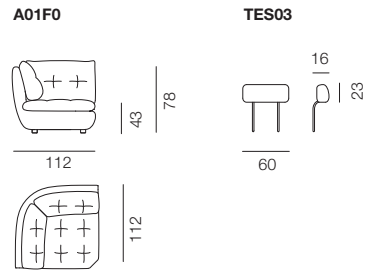

**Poggiatesta  
Headrest  
Appui-tête**

**Angolare  
Corner element  
Eléments d'angle**

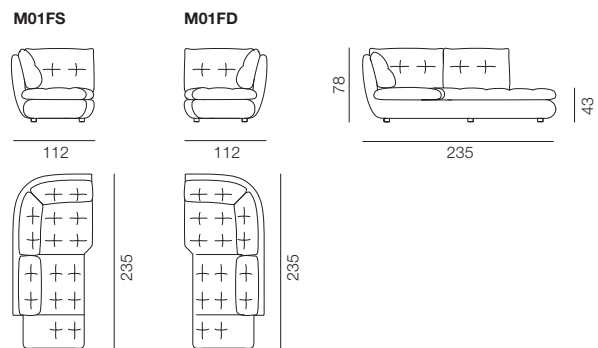



# MODULAR COMFY

138

Ibiza



148

Gipsy



156

Deneris



174

Caribe



Il nuovo progetto componibile di Andrea Arena per un living contemporaneo, personale, accogliente. Una collezione di imbottiti dove rilassarsi, leggere, stare insieme. Moduli singoli, ad angolo, chaise longue e pouf che disegnano soluzioni ogni volta diverse.

The new modular project by Andrea Arena for a contemporary, personal and welcoming living room. A collection of upholstered furniture where you can relax, read, be together. Single modules, corner, chaise longue and pouf that design different solutions every time.

Le nouveau projet modulable d'Andrea Arena pour une ambiance contemporaine, personnelle, accueillante. Une collection de canapés où vous pourrez vous détendre, lire, être ensemble. Modules individuels, modules d'angle, chaises longues et poufs qui créent des combinaisons différentes à chaque fois.





# IBIZA

designed by Andrea Arena

Un sistema di divani rifinita con cuscini extra-large. Un gioco di forme di ispirazione vintage. Ibiza crea un'atmosfera nostalgica e uno stile di grande tendenza. Un vero e proprio pezzo di design. I cuscini e la profondità extra massimizzano il comfort. Caratterizzata dalla cucitura questa famiglia di divani viene proposta nei nuovi speciali uno su tutti, l'effetto velluto.

A sofa system finished with extra-large cushions. A game of vintage-inspired forms. Ibiza creates a nostalgic atmosphere and a very trend style. A real "piece" of design. The cushions and extra depth maximize comfort. Characterized by the seam this family of sofas is proposed in the new special one above all, the velvet effect.

Un système de canapé fini avec des coussins extra-larges. Un jeu de formes d'inspiration vintage. Ibiza crée une atmosphère nostalgique et un style très tendance. Une véritable "pièce" de design. Les coussins et la profondeur supplémentaires maximisent le confort. Caractérisé par la couture cette famille de canapés est proposée dans le nouveau spécial avant tout, l'effet velours.



— 1 Ibiza:

tessuto Creola col.706 / tessuto Leida col.37  
fabric Creola col.706 / fabric Leida col.37  
tissu Creola col.706 / tissu Leida col.37

— 2 Ibiza:

tessuto Leida col.66 / tessuto Creola col.606  
fabric Leida col.66 / fabric Creola col.606  
tissu Leida col.66 / tissu Creola col.606

— 3 Ibiza:

tessuto Creola col.701 / tessuto Leida col.57  
fabric Creola col.701 / fabric Leida col.57  
tissu Creola col.701 / tissu Leida col.57

— 4 Ibiza:

tessuto Leida col.37 / tessuto Creola col.706  
fabric Leida col.37 / fabric Creola col.706  
tissu Leida col.37 / tissu Creola col.706

— 5 Ibiza:

tessuto Creola col.610 / tessuto Leida col.08  
fabric Creola col.610 / fabric Leida col.08  
tissu Creola col.610 / tissu Leida col.08

— 6 Ibiza:

tessuto Leida col.08 / tessuto Creola col.610  
fabric Leida col.08 / fabric Creola col.610  
tissu Leida col.08 / tissu Creola col.610

— 7 Ibiza:

tessuto Creola col.606 / tessuto Leida col.66  
fabric Creola col.606 / fabric Leida col.66  
tissu Creola col.606 / tissu Leida col.66









— **1 Ibiza:**  
tessuto Creola col.701 / tessuto Leida col.57  
fabric Creola col.701 / fabric Leida col.57  
tissu Creola col.701 / tissu Leida col.57

— **2 Ibiza:**  
tessuto Leida col.66 / tessuto Creola col.606  
fabric Leida col.66 / fabric Creola col.606  
tissu Leida col.66 / tissu Creola col.606

— **3 Ibiza:**  
tessuto Creola col.610 / tessuto Leida col.08  
fabric Creola col.610 / fabric Leida col.08  
tissu Creola col.610 / tissu Leida col.08

— **4 Ibiza:**  
tessuto Creola col.606 / tessuto Leida col.66  
fabric Creola col.606 / fabric Leida col.66  
tissu Creola col.606 / tissu Leida col.66

— **5 Celine:**  
tessuto Frida col.07 / fettuccia Grosgrain col 88  
amaranto / metallo M310 antracite  
fabric Frida col.07 / piping Grosgrain col 88  
amaranto / Anthracite metal M310  
tissu Frida col.07 / passepoil Grosgrain col 88  
amaranto / métal M310 Anthracite

5



4



1





# IBIZA

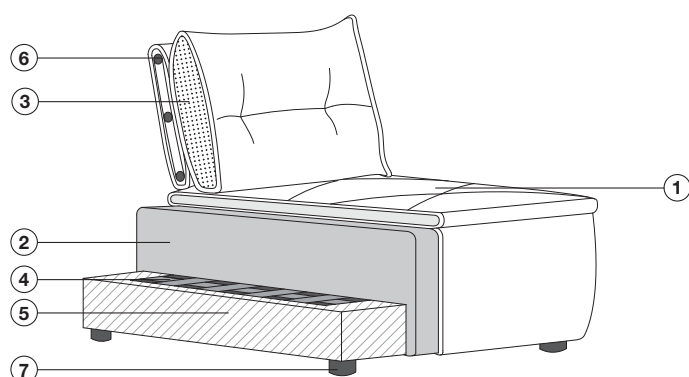

- 1 / Rivestimento
- 2 / Imbottitura seduta: poliuretano espanso HT 35 kg/m<sup>3</sup> ricoperto con resinato accoppiato
- 3 / Imbottitura schienale: fibra di poliestere sfioccato e particelle di poliuretano espanso
- 4 / Sistema di molleggio: cinghie elastiche incrociate
- 5 / Struttura portante: legno massello e multistrato con parti in agglomerato
- 6 / Struttura schienale: metallo
- 7 / Piedi in ABS antiscivolo

- 1 / Sofa covering
- 2 / Seat padding: expanded polyurethane HT 35 kg/m<sup>3</sup> covered with coupled wadding resin
- 3 / Backrest padding: polyester fiber and expanded polyurethane particles
- 4 / Springing: suspension with elastic crossing belts
- 5 / Structure: solid wood and multilayer frame with parts in plywood and particle board
- 6 / Backrest structure: metal
- 7 / Antislip ABS feet

- 1 / Revêtement
- 2 / Rembourrage assise: polyuréthane expansé HT 35 Kg/m<sup>3</sup> recouvert en résiné couplé
- 3 / Rembourrage dossier: fibre de polyester en flocons et particules de polyuréthane expansé
- 4 / Système de suspension: sangles élastiques entrecroisées
- 5 / Structure portante: bois massif et panneaux agglomérés ou multicouche
- 6 / Structure dossier: métal
- 7 / Pieds ABS antidérapant

**Centrale 1 posto**  
**Central element 1 seater**  
**Chauffeuse 1 place**

C10F0

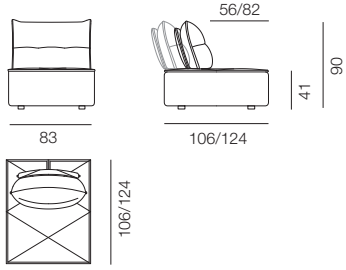

**Centrale 1 posto grande**  
**Central element 1 seater big**  
**Chauffeuse 1 place grande**

C15F0

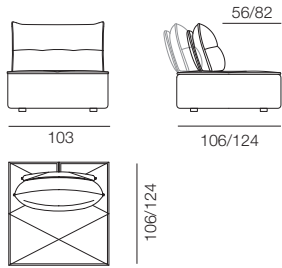

**Centrale 2 posti**  
**Central element 2 seaters**  
**Banquette 2 places**

C20F0

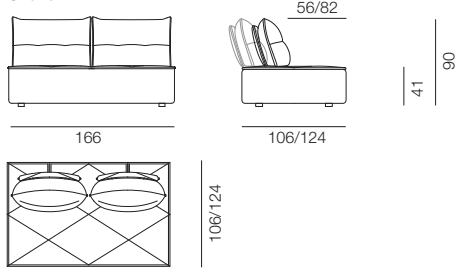

**Chaise longue**  
**Chaise longue**  
**Chaise longue**

M01F0

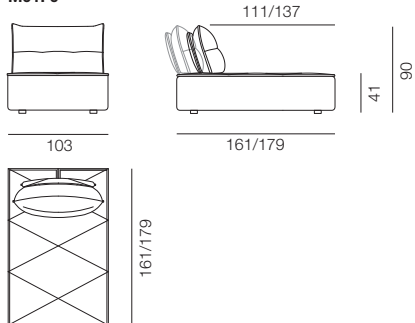

**Pouf rettangolare**  
**Rectangular pouf**  
**Pouf rectangulaire**

P01F0

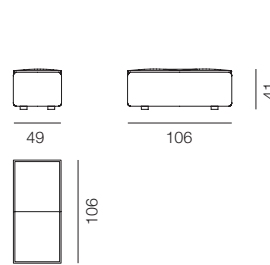

**Schienale libero 3 posti**  
**Free backrest 3 places**  
**Dossier amovible 3 places**

S300M

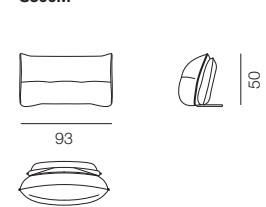

**Pouf quadrato**  
**Squared pouf**  
**Pouf carré**

P02F0

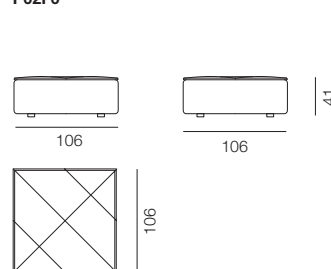

**Poggiatesta**  
**Headrest**  
**Appui-tête**

TES03

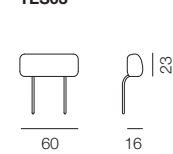





# GIPSY

designed by Andrea Arena

Viaggiare, senza spostarsi. Gipsy evoca atmosfere e profumi di seducenti angoli di mondo. Blocchi modulari combinabili per cromie affini o contrastanti danno vita a uno stuzzicante gioco di possibilità. Volumi complementari replicabili all'infinito, per atterrare ogni giorno nella propria isola di intimo relax domestico.

Imagine to set off for a journey without having to move from home. Gipsy brings to mind the atmosphere and fragrances of fascinating corners of the world. Its modules with matching or contrasting colours open the doors to infinite possibilities. Complementary volumes can be replicated infinite times to travel to a distant island of intimate relaxation.

Voyager, sans se déplacer. Le Gipsy évoque des atmosphères et des parfums provenant de séduisants angles du monde. Des blocs modulaires combinables par couleurs similaires ou contrastées donnent vie à un jeu émoustillant de possibilités. Volumes complémentaires indéfiniment répliquables pour se poser chaque jour dans la propre île de relax et d'intimité personnelle.







— 1 Gipsy:

tessuto Leida col.3060 / tessuto Rosella col.05  
fabric Leida col.3060 / fabric Rosella col.05  
tissu Leida col.3060 / tissu Rosella col.05

— 2 Gipsy:

tessuto Leida col.38 / tessuto Felicità col.04  
fabric Leida col.38 / fabric Felicità col.04  
tissu Leida col.38 / tissu Felicità col.04

— 4 Gipsy:

tessuto Leida col.66 / tessuto Leida col.38  
fabric Leida col.66 / fabric Leida col.38  
tissu Leida col.66 / tissu Leida col.38

— 3 Gipsy:

tessuto Leida col.79 / tessuto Leida col.3060  
fabric Leida col.79 / fabric Leida col.3060  
tissu Leida col.79 / tissu Leida col.3060

— 5 Gipsy:

tessuto Leida col.38 / tessuto Leida col.03  
fabric Leida col.38 / fabric Leida col.03  
tissu Leida col.38 / tissu Leida col.03

— 6 Gipsy:

tessuto Leida col.3060 / tessuto Leida col.79  
fabric Leida col.3060 / fabric Leida col.79  
tissu Leida col.3060 / tissu Leida col.79

— 7 Gipsy:

tessuto Rosella col.06 / tessuto Leida col.79  
fabric Rosella col.06 / fabric Leida col.79  
tissu Rosella col.06 / tissu Leida col.79

— 8 Gipsy:

tessuto Leida col.38 / tessuto Leida col.66  
fabric Leida col.38 / fabric Leida col.66  
tissu Leida col.38 / tissu Leida col.66







# GIPSY

• AERRE ITALIA •  
DYNAMIC SOFA

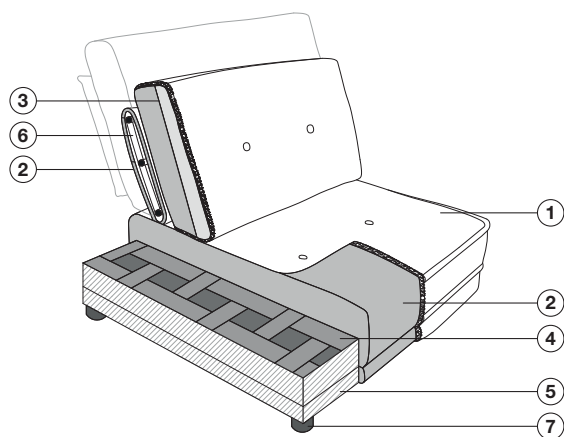
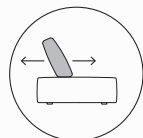

- 1 / Rivestimento
- 2 / Imbottitura seduta: poliuretano HT 35 Kg/m<sup>3</sup> ricoperto con resinato accoppiato
- 3 / Imbottitura schienale: poliuretano espanso a densità differenziata
- 4 / Sistema di molleggio: cinghie elastiche incrociate
- 5 / Struttura portante: legno massello e multistrato con parti in agglomerato
- 6 / Struttura schienale: metallo
- 7 / Piedi in ABS antiscivolo

- 1 / Sofa covering
- 2 / Seat padding: expanded polyurethane HT 35 kg/m<sup>3</sup> covered with coupled wadding resin
- 3 / Backrest padding: expanded polyurethane in variable density
- 4 / Springing: suspension with elastic crossing belts
- 5 / Structure: solid wood and multilayer frame with parts in plywood and particle board
- 6 / Backrest structure: metal
- 7 / Antislip ABS feet

- 1 / Revêtement
- 2 / Rembourrage assise: polyuréthane expansé HT 35 Kg/m<sup>3</sup> recouvert en résiné couplé
- 3 / Rembourrage dossier: polyuréthane expansé multi-densité
- 4 / Système de suspension: sangles élastiques entrecroisées
- 5 / Structure portante: bois massif et panneaux agglomérés ou multicouche
- 6 / Structure dossier: métal
- 7 / Pieds ABS antidérapant



**Elementi centrali**  
**Central elements**  
**Chauffeuses et banquette**

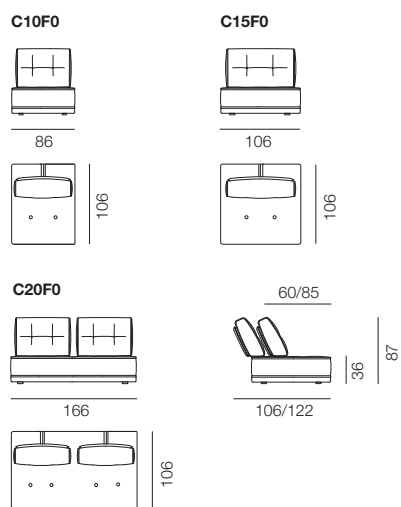

**Pouf**  
**Pouf**  
**Poufs**

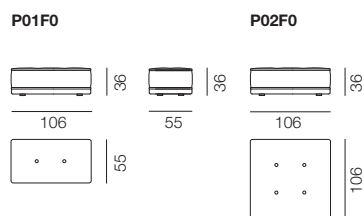

GIPSY

**Chaise longue**  
**Chaise longue**  
**Chaise longue**

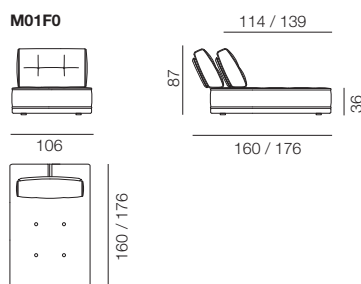

**Schienali liberi**  
**Removable backrests**  
**Dossiers amovibles**



**Poggiatesta**  
**Headrest**  
**Appuie-tête**

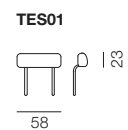



# DENERIS

designed by Andrea Arena

Un divano che cambia, per uno spazio living mai uguale a se stesso. Linee capaci di adattarsi a umori, momenti, stagioni, seguendo l'andamento della vita. Massima libertà compositiva, dove le sedute possono essere spostate e combinate e gli schienali posizionati a piacere per dare forma alla propria idea di comodità.

A changing sofa for a living room that is never the same. Its lines adapt to moods, seasons, and moments in life. Its modularity unleashes your creativity. You can move the seats around and combine them with the backrest positioned wherever you want to express your idea of comfort.

Un canapé qui change, pour un espace living jamais identique à lui-même. Lignes qui s'adaptent aux humeurs, aux moments, aux saisons, en suivant le cours de la vie. Liberté maximale de modularité, où les assises peuvent être déplacées et combinées, et où les dossiers peuvent être positionnés librement pour donner forme à des idées personnelles de confort.



— 1 Deneris free:

tessuto Ciccio col.351 / pelle cat.800 Seta 9211  
Shadow / metallo m310 antracite  
fabric Ciccio col.351 / leather cat.800 Seta 9211  
Shadow / Anthracite metal M310  
tissu Ciccio col.351 / cuir cat.800 Seta 9211  
Shadow / métal M310 Anthracite

— 2 Celine:

tessuto Leida col.57 / Leida col.53 / metallo M310 antracite  
fabric Leida col.57 / Leida col.53 / Anthracite metal M310  
tissu Leida col.57 / Leida col.53 / métal M310 Anthracite

1

2











— 1 Deneris free:

tessuto Morris col.03 / pelle cat.800 Seta 9022 Minerale / metallo 55 nero  
fabric Morris col.03 / leather cat.800 Seta 9022 Minerale / metal 55 black  
tissu Morris col.03 / cuir cat.800 Seta 9022 Minerale / métal 55 noi

— 2 Schienale trapezio libero / Removable trapeze backrest /  
Dossier trapèze amovible

tessuto Ray col.03 / Pixel pelle cat.800 Seta 9022 Minerale / metallo 55 nero  
fabric Ray col.03 / Pixel leather cat.800 Seta 9022 Minerale / metal 55 black  
tissu Ray col.03 / Pixel cuir cat.800 Seta 9022 Minerale / métal 55 noir

— 3 Deneris free:

pelle cat.800 Seta 9022 Minerale / metallo 55 nero  
leather cat.800 Seta 9022 Minerale / metal 55 black  
cuir cat.800 Seta 9022 Minerale / métal 55 noir















— **1 Deneris plus:**  
tessuto Leida col.49 / Piede Emerald M310 antracite  
fabric Leida col.49 / Anthracite Emerald feet M310  
tissu Leida col.49 / Pied Emerald M310 antracite

— **2 Deneris plus:**  
Tessuto leida col. 49 / Piede Roma M310 anthracite  
Fabric Leida col. 49 / Anthracite Roma M310 feet  
Tissu Leida col. 49 / Pied Roma M310 anthracite





— **1 Deneris plus:**  
pelle cat.800 Seta 9039 pavone / metallo 306 bianco  
leather cat.800 Seta 9039 pavone / metal 306 white  
cuir cat.800 Seta 9039 pavone / métal 306 blanc

— **2 Deneris plus:**  
pelle cat.800 Seta 9301 dash / metallo 306 bianco  
leather cat.800 Seta 9301 dash / metal 306 white  
cuir cat.800 Seta 9301 dash / métal 306 blanc









# DENERIS FREE

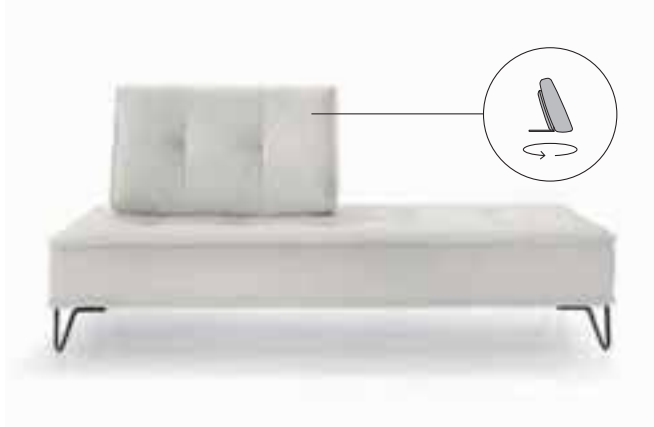

**Finiture metallo piede Emerald**  
**Emerald feet metal finishes**  
**Finitions métalliques pied Emerald**

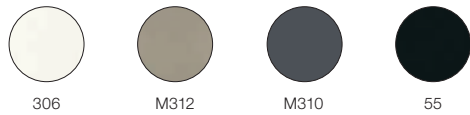

**Finiture metallo piede Roma**  
**Emerald feet metal finishes**  
**Finitions métalliques pied Emerald**

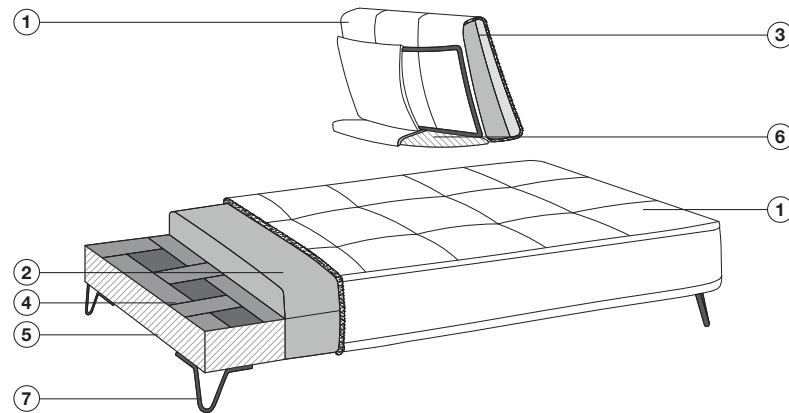
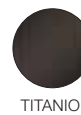

- 1 / Rivestimento
- 2 / Imbottitura seduta: poliuretano espanso HT 35 kg/m<sup>3</sup> ricoperto con resinato accoppiato
- 3 / Imbottitura schienale: poliuretano espanso a densità differenziata
- 4 / Sistema di molleggio: cinghie elastiche incrociate
- 5 / Struttura portante: legno massello e multistrato con parti in agglomerato
- 6 / Struttura schienale: base in multistrato e scheletro in metallo
- 7 / Piedi in metallo

- 1 / Sofa covering
- 2 / Seat padding: expanded polyurethane HT 35 kg/m<sup>3</sup> covered with coupled wadding resin
- 3 / Backrest padding: expanded polyurethane in variable density
- 4 / Springing: suspension with elastic crossing belts
- 5 / Structure: solid wood and multilayer frame with parts in plywood and particle board
- 6 / Backrest structure: multilayer base and metal frame
- 7 / Metal feet

- 1 / Revêtement
- 2 / Rembourrage assise: polyuréthane expansé HT 35 Kg/m<sup>3</sup> recouvert en résiné couplé
- 3 / Rembourrage dossiers: polyuréthane expansé multi-densité
- 4 / Système de suspension: sangles élastiques entrecroisées
- 5 / Structure portante: bois massif et panneaux agglomérés ou multicouche
- 6 / Structure dossiers: panneaux multicouche et structure en métal
- 7 / Pieds en métal

**Elementi centrali**  
**Central elements**  
**Banquettes**

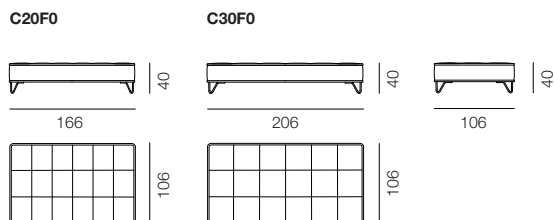

**Pouf**  
**Pouf**  
**Poufs**

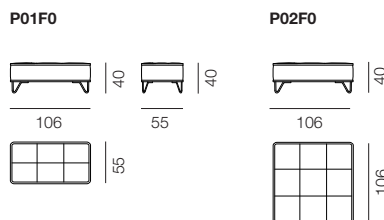

**Schienali liberi**  
**Removable backrests**  
**Dossiers amovibles**

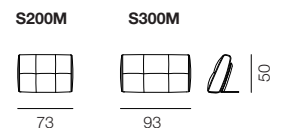

# DENERIS PLUS



**Finiture metallo piede Emerald**  
**Emerald feet metal finishes**  
**Finitions métalliques pied Emerald**



**Finiture metallo piede Emerald**  
**Emerald feet metal finishes**  
**Finitions métalliques pied Emerald**

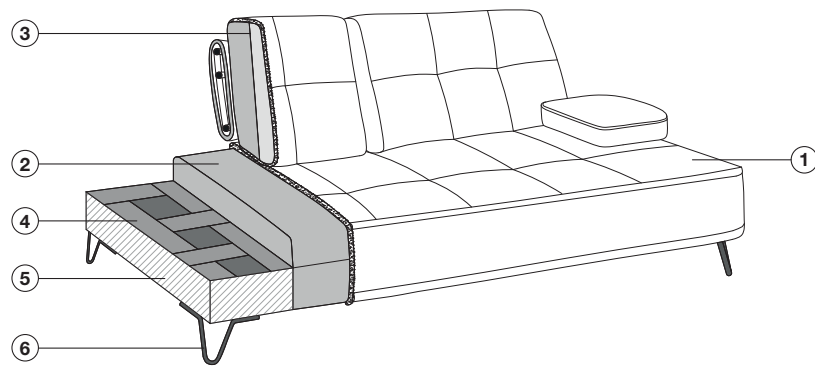
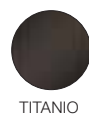

**1 / Rivestimento**  
**2 / Imbottitura seduta:** poliuretano espanso HT 35 kg/m<sup>3</sup> ricoperto con resinato accoppiato  
**3 / Imbottitura schienale:** poliuretano espanso a densità differenziata  
**4 / Sistema di molleggio:** cinghie elastiche incrociate  
**5 / Struttura portante:** legno massello e multistrato con parti in agglomerato  
**6 / Piedi in metallo**

**1 / Sofa covering**  
**2 / Seat padding:** expanded polyurethane HT 35 kg/m<sup>3</sup> covered with coupled wadding resin  
**3 / Backrest padding:** expanded polyurethane in variable density  
**4 / Springing:** suspension with elastic crossing belts  
**5 / Structure:** solid wood and multilayer frame with parts in plywood and particle board  
**6 / Metal feet**

**1 / Revêtement**  
**2 / Rembourrage assise:** polyuréthane expansé HT 35 Kg/m<sup>3</sup> recouvert en résiné couplé  
**3 / Rembourrage dossier:** polyuréthane expansé multi-densité  
**4 / Système de suspension:** sangles élastiques entrecroisées  
**5 / Structure portante:** bois massif et panneaux agglomérés ou multicouche  
**6 / Pieds en métal**



**Divani  
Sofas  
Canapés**

**D20F0**

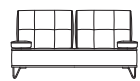

166/200

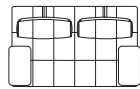

106 / 122

**D30F0**

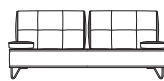

206/240

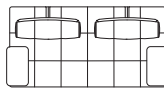

106 / 122

60/85



106/122

40

90

**Elementi centrali  
Central elements  
Chauffeuses et banquettes**

**C10F0**



86



106 / 122

**C15F0**



106



106 / 122

**C20F0**

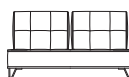

166

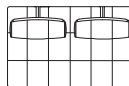

106 / 122

**C30F0**

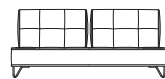

206

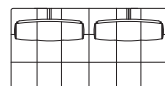

106 / 122

60/85



106/122

40

90

**Elementi terminali  
Terminal elements  
Batards**

**B20FS**

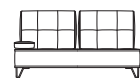

166/183

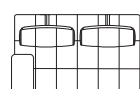

106 / 122

**B20FD**

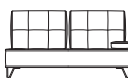

166/183

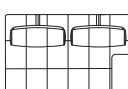

106 / 122

**B30FS**

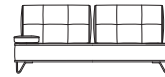

206/223

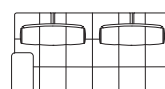

106 / 122

**B30FD**

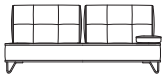

206/223

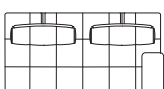

106 / 122

**Chaise longue  
Chaise longue  
Chaises longues**

**M01F0**



106

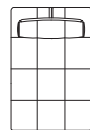

160 / 175

114/139



160/175

90

40

**M01FS**



106/123

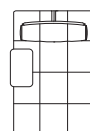

160 / 175

**M01FD**



106/123

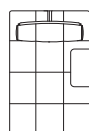

160 / 175

114/139



160/175

90

40

**Pouf  
Pouf  
Poufs**

**P01F0**



106



55

**P02F0**



106



106

**Poggiatesta  
Headrest  
Appuie-tête**

**TES01**



58

**Schienale libero trapezio 2 posti  
2-seater removable trapeze backrest  
Dossier trapèze amovible 2 places**

**S200T**



75



22



32

36

**Schienale libero trapezio 2 posti  
2-seater removable trapeze backrest  
Dossier trapèze amovible 2 places**

**S300T**



85



22



32

36



# CARIBE

designed by Andrea Arena

Lo charm femminile si coniuga nella piena libertà espressiva delle morbide forme e trame di Caribe. Un sistema che dà spazio alle infinite sfumature personali per vivere ogni ambiente in maniera unica e raffinata. I suoi esclusivi schienali liberi permettono di comporre i diversi moduli declinando il proprio gusto verso una comoda seduta o un ampio spazio unico, come una grande alcova in cui abbandonarsi.

Feminine charm merges with the freedom of expression of Caribe's sinuous shapes and weaves. A system that makes room for infinite customised nuances to create a unique and sophisticated setting. Its exclusive removable backrest allow for various compositions that create a comfortable seat or a single large space that becomes a cosy haven.

Le charme féminin se conjugue dans la pleine liberté expressive des formes souples et des trames du Caribe. Un système qui laisse place aux nuances personnelles infinies pour vivre chaque ambiance de façon unique et raffinée. Ses dossiers amovibles exclusifs permettent de composer différents modules en déclinant le propre goût pour une assise ou un ample espace unique, comme une grande alcôve dans laquelle s'abandonner.







— 1 Caribe:

tessuto Ciccio col.351 / tessuto  
Leida col.03  
fabric Ciccio col.351 / fabric  
Leida col.03  
tissu Ciccio col.351 / tissu  
Leida col.03

— 2 Caribe:

tessuto Ciccio col.351 / tessuto  
Leida col.03  
fabric Ciccio col.351 / fabric  
Leida col.03  
tissu Ciccio col.351 / tissu  
Leida col.03

— 3 Caribe:

tessuto Ciccio col.447 / tessuto  
Leida col.47  
fabric Ciccio col.447 / fabric  
Leida col.47  
tissu Ciccio col.447 / tissu  
Leida col.47

— 4 Caribe schienale libero /  
Caribe removable backrest /  
Caribe dossiers amovible:

tessuto Ciccio col.447  
fabric Ciccio col.447  
tissu Ciccio col.447

— 5 Caribe schienale libero /  
Caribe removable backrest /  
Caribe dossiers amovible:

tessuto Ciccio col.543  
fabric Ciccio col.543  
tissu Ciccio col.543

— 6 Caribe schienale libero /  
Caribe removable backrest /  
Caribe dossiers amovibles:

tessuto Ciccio col.351  
fabric Ciccio col.351  
tissu Ciccio col.351

— 7 Caribe schienale libero /  
Caribe removable backrest /  
Caribe dossiers amovibles:

tessuto Leida col.47  
fabric Leida col.47  
tissu Leida col.47

— 8 Caribe:

tessuto Ciccio col.351 /  
tessuto Ciccio col.543  
fabric Ciccio col.351 /  
fabric Ciccio col.543  
tissu Ciccio col.351 /  
tissu Ciccio col.543





# CARIBE

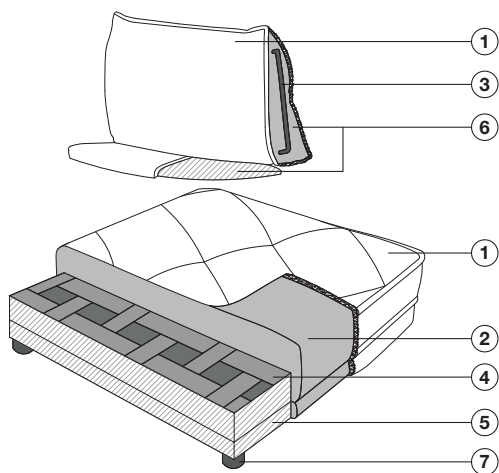

- 1 / Rivestimento
- 2 / Imbottitura seduta: poliuretano espanso HT 35 kg/m<sup>3</sup> ricoperto con resinato accoppiato
- 3 / Imbottitura schienale: poliuretano espanso a densità differenziata
- 4 / Sistema di molleggio: cinghie elastiche incrociate
- 5 / Struttura portante: legno massello e multistrato con parti in agglomerato
- 6 / Struttura schienale: base in multistrato e scheletro in metallo
- 7 / Piedi in ABS antiscivolo

- 1 / Sofa covering
- 2 / Seat padding: expanded polyurethane HT 35 kg/m<sup>3</sup> covered with coupled wadding resin
- 3 / Backrest padding: expanded polyurethane in variable density
- 4 / Springing: suspension with elastic crossing belts
- 5 / Structure: solid wood and multilayer frame with parts in plywood and particle board
- 6 / Backrest structure: multilayer base and metal frame
- 7 / Antislip ABS feet

- 1 / Revêtement
- 2 / Rembourrage assise: polyuréthane expansé HT 35 Kg/m<sup>3</sup> recouvert en résiné couplé
- 3 / Rembourrage dossier: polyuréthane expansé multi-densité
- 4 / Système de suspension: sangles élastiques entrecroisées
- 5 / Structure portante: bois massif et panneaux agglomérés ou multicouche
- 6 / Structure dossiers: panneaux multicouche et structure en métal
- 7 / Pieds ABS antidérapant

## Elementi centrali Central elements Banquettes

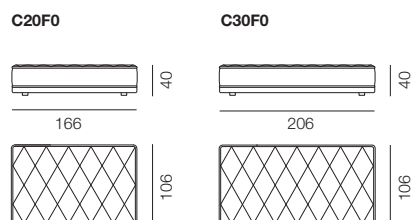

## Pouf Pouf Poufs

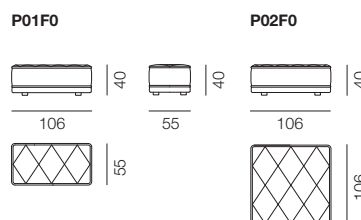

## Schienali liberi Removable backrests Dossiers amovibles

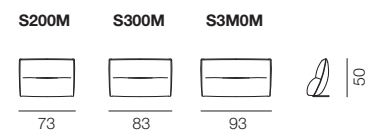

# 182

Smoothie



# SOFA \_BED

192

Nappy



202

Mango



212

Dorico



220

Amandine



230

Texas



Il divano letto che unisce l'utilità di un posto letto  
alla comodità di una seduta.

The sofa bed that combines the usefulness of a  
sleeping place with the comfort of a seat.

Le canapé-lit qui allie l'utilité d'un lit au confort  
d'une assise.





# SMOOTHIE

designed by Andrea Arena

Grazie alle dimensioni compatte, il divano Smoothie riesce ad adattarsi facilmente alle diverse esigenze abitative come appartamenti di dimensioni contenute, camere/studio e case vacanze. La combinazione di funzione letto e "comfort" rende infatti questo modello ideale sia come letto che come divano.

Thanks to its compact size, the Smoothie sofa is able to easily adapt to different housing needs such as small apartments, rooms / studios and holiday homes. The combination of bed function and "comfort" makes this model ideal both as a bed and as a sofa.

Grâce à sa taille compacte, le canapé Smoothie est capable de s'adapter facilement à différents besoins de logement tels que les petits appartements, les chambres / studios et les maisons de vacances. La combinaison de la fonction du lit et du « confort » rend ce modèle idéal à la fois comme lit et comme canapé.

— **1 Smoothie:**  
tessuto Frida col.08  
fabric Frida col.08  
tissu Frida col.08

— **2 Smoothie:**  
tessuto Cinema col.57  
fabric Cinema col.57  
tissu Cinema col.57





2

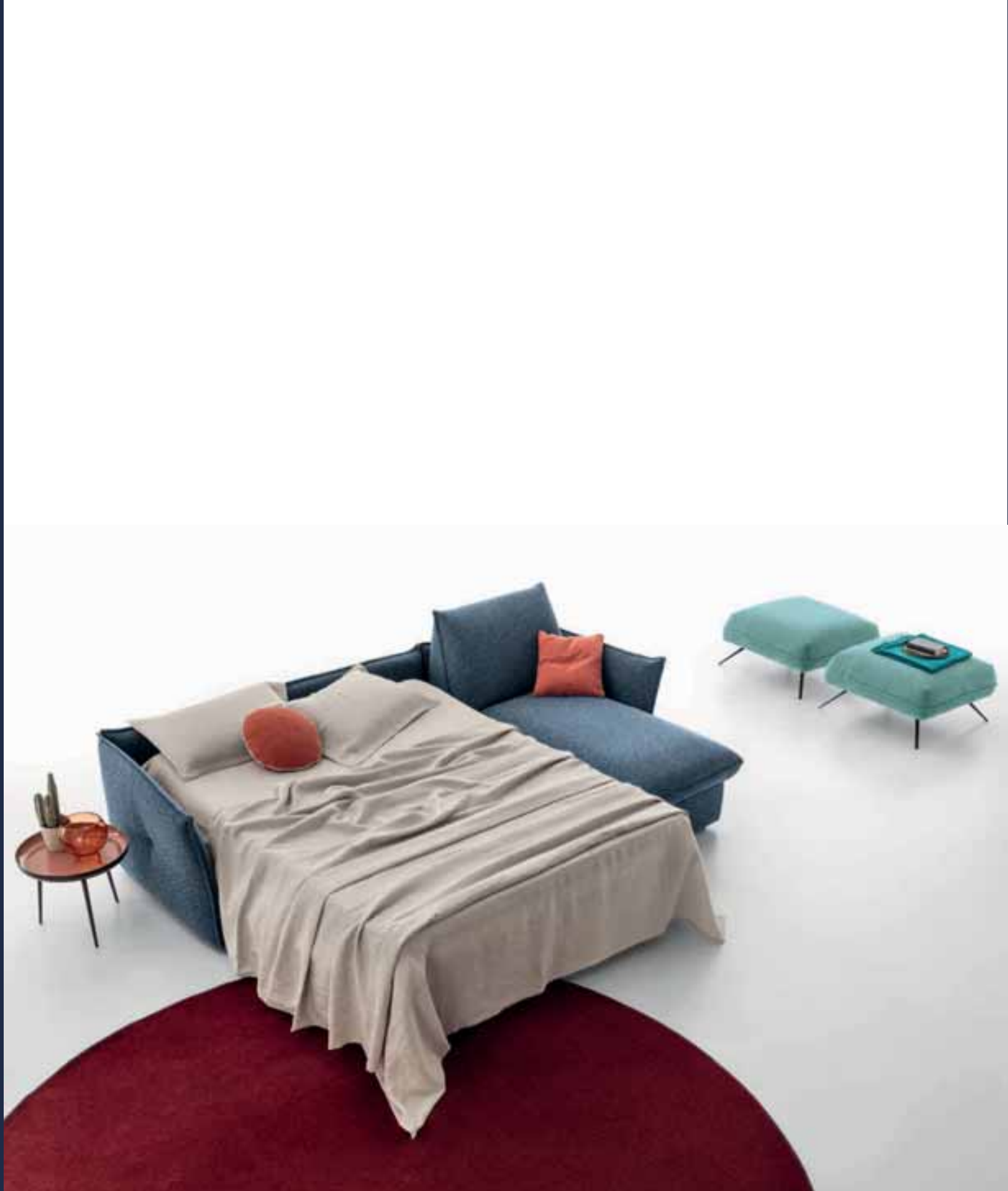









# SMOOTHIE

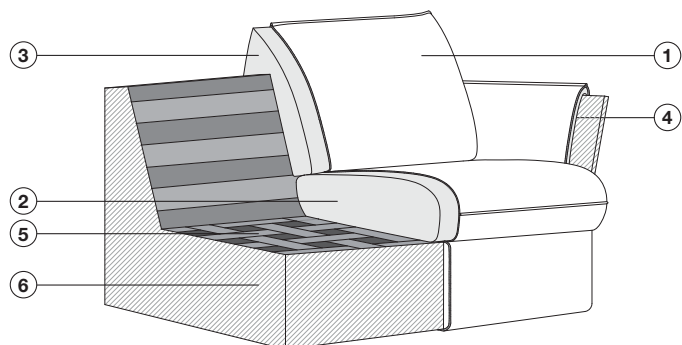

- 1 / Rivestimento
- 2 / Imbottitura seduta: poliuretano espanso 30 kg/m<sup>3</sup> ricoperto con resinato accoppiato
- 3 / Imbottitura schienale: poliuretano espanso SUPER SOFT ricoperto con resinato accoppiato
- 4 / Imbottitura bracciolo: poliuretano espanso ricoperto con resinato accoppiato
- 5 / Sistema di molleggio: cinghie elastiche incrociate
- 6 / Struttura portante: legno massello e multistrato con parti in agglomerato
- 7 / Piedi a spillo (non visibili)

- 1 / Sofa covering
- 2 / Seat padding: expanded polyurethane 30 kg/m<sup>3</sup> covered with coupled wadding resin
- 3 / Backrest padding: expanded polyurethane 18 kg/m<sup>3</sup> SUPER SOFT covered with resin wadding
- 4 / Armrest padding: expanded polyurethane covered with coupled wadding resin
- 5 / Springing: suspension with elastic crossing belts
- 6 / Structure: solid wood and multilayer frame with parts in plywood and particle board
- 7 / Cylindrical feet (not visible)

- 1 / Revêtement
- 2 / Rembourrage assise: polyuréthane expansé 30 Kg/m<sup>3</sup> recouvert en résiné couplé
- 3 / Rembourrage dossier: polyuréthane expansé SUPER SOFT recouvert en résiné couplé
- 4 / Rembourrage accoudoir: polyuréthane expansé recouvert en résiné couplé
- 5 / Système de suspension: sangles élastiques entrecroisées
- 6 / Structure portante: bois massif et panneaux agglomérés ou multicouche
- 7 / Pieds cylindriques (non visibles)

**Terminale 2 posti dx/sx**  
**2-seater terminal right/left**  
**Batard 2 places droit/gauche**

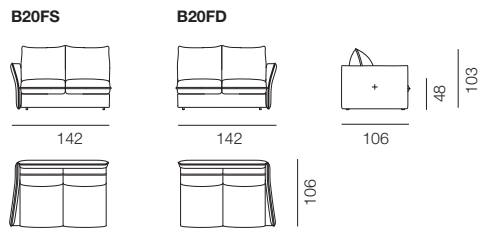

**Divano 2 posti**  
**Sofa 2 seaters**  
**Canapé 2 places**

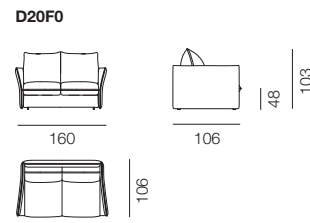

**Terminale 3 posti dx/sx**  
**3-seater terminal right/left**  
**Batard 3 places droit/gauche**

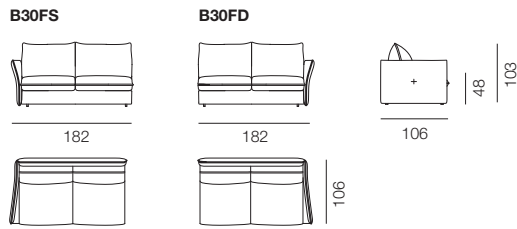

**Divano 3 posti**  
**Sofa 3 seaters**  
**Canapé 3 places**

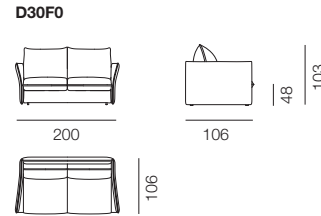

**Terminale 3 posti letto dx/sx**  
**3-seater terminal with bed right/left**  
**Batard 3 places lit droit/gauche**

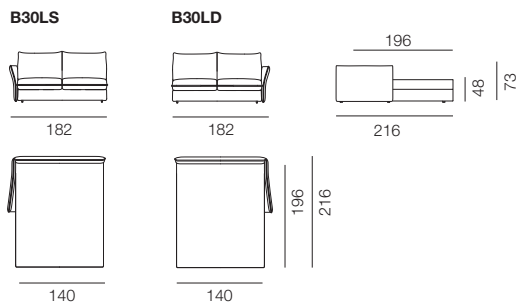

**Divano 3 posti letto**  
**Sofa 3 seaters bed**  
**Canapé 3 places lit**

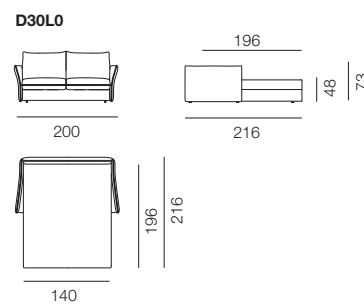

**Terminale 3 posti maxi letto dx/sx**  
**3-seater terminal maxi with bed right/left**  
**Batard 3 places lit maxi droit/gauche**

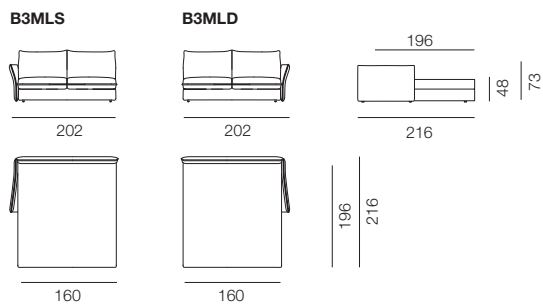

**Divano 3 posti maxi letto**  
**Sofa 3 seaters maxi bed**  
**Canapé 3 places maxi lit**

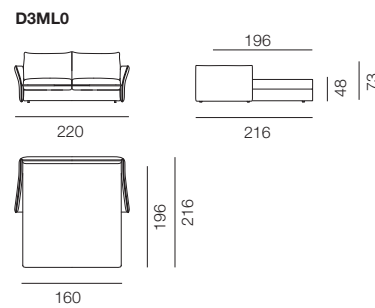

**Chaise longue contenitore dx/sx**  
**Chaise longue with box right / left**  
**Chaise longue droite/gauche avec coffre**

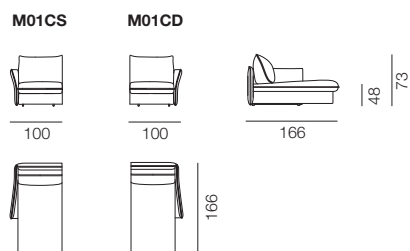





# NAPPY

designed by Andrea Arena

Nappy è un divano letto dotato di un pratico accessorio bracciolo - tavolino porta oggetti. Progettato per un uso frequente o quotidiano.

Nappy is a sofa bed equipped with a practical armrest - coffee table accessory for objects. Designed for frequent or daily use.

Nappy est un canapé-lit équipé d'un accoudoir pratique - accessoire de table basse pour les objets. Conçu pour une utilisation fréquente ou quotidienne.

— **1 Nappy:**  
tessuto Frise col.606  
fabric Frise col.606  
tissu Frida col.606

— **2 Gea:**  
tessuto Leida col.49 / tessuto Frise col.402  
fabric Leida col.49 / fabric Frise col.402  
tissu Leida col.49 / tissu Frise col.402









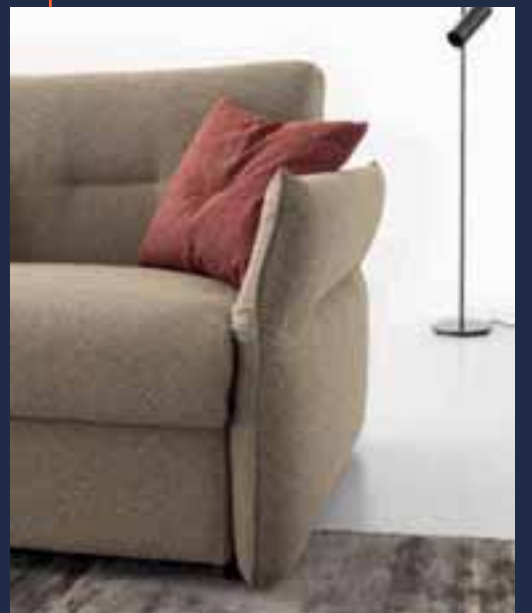
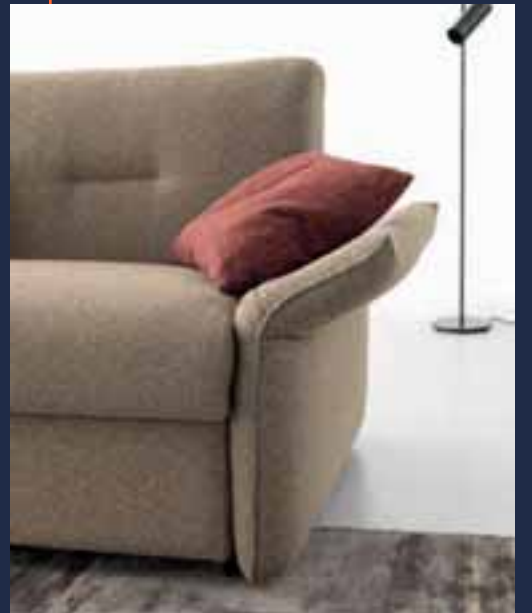
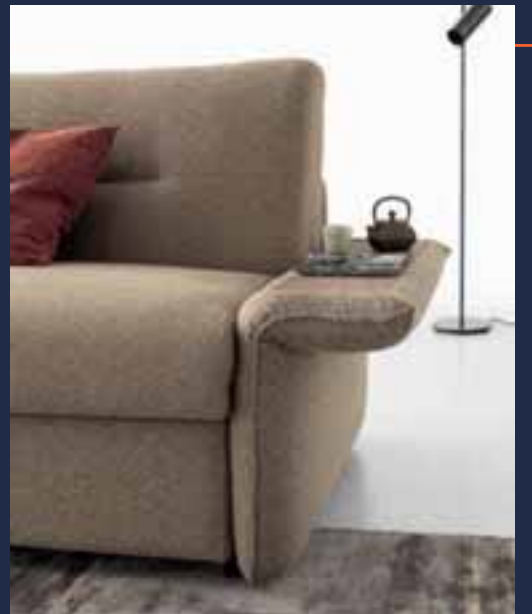







# NAPPY

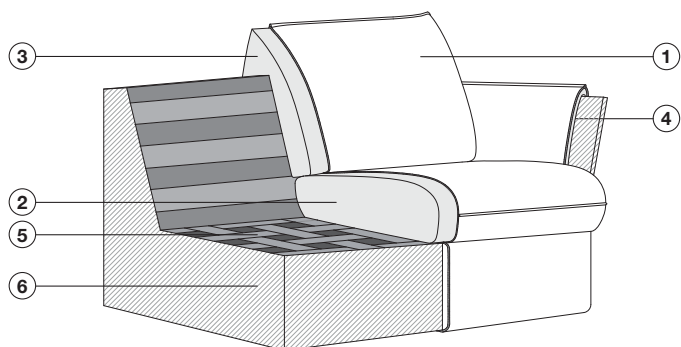

- 1 / Rivestimento
- 2 / Imbottitura seduta: poliuretano espanso 30 kg/m<sup>3</sup> ricoperto con resinato accoppiato
- 3 / Imbottitura schienale: poliuretano espanso SUPER SOFT ricoperto con resinato accoppiato
- 4 / Imbottitura bracciolo: poliuretano espanso ricoperto con resinato accoppiato
- 5 / Sistema di molleggio: cinghie elastiche incrociate
- 6 / Struttura portante: legno massello e multistrato con parti in agglomerato
- 7 / Piedi a spillo (non visibili)

- 1 / Sofa covering
- 2 / Seat padding: expanded polyurethane 30 kg/m<sup>3</sup> covered with coupled wadding resin
- 3 / Backrest padding: expanded polyurethane 18 kg/m<sup>3</sup> SUPER SOFT covered with resin wadding
- 4 / Armrest padding: expanded polyurethane covered with coupled wadding resin
- 5 / Springing: suspension with elastic crossing belts
- 6 / Structure: solid wood and multilayer frame with parts in plywood and particle board
- 7 / Cylindrical feet (not visible)

- 1 / Revêtement
- 2 / Rembourrage assise: polyuréthane expansé 30 Kg/m<sup>3</sup> recouvert en résiné couplé
- 3 / Rembourrage dossier: polyuréthane expansé SUPER SOFT recouvert en résiné couplé
- 4 / Rembourrage accoudoir: polyuréthane expansé recouvert en résiné couplé
- 5 / Système de suspension: sangles élastiques entrecroisées
- 6 / Structure portante: bois massif et panneaux agglomérés ou multicouche
- 7 / Pieds cylindriques (non visibles)

**Terminale 2 posti dx/sx**  
**2-seater terminal right / left**  
**Batard 2 places droit/gauche**

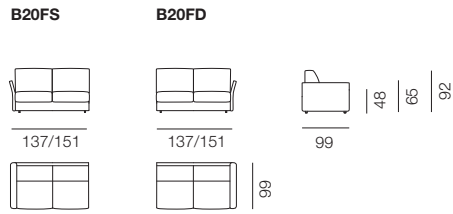

**Divano 2 posti**  
**Sofa 2 seaters**  
**Canapé 2 places**

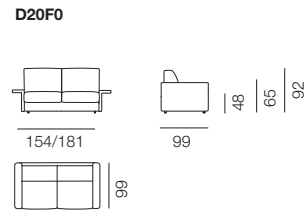

**Terminale 3 posti dx/sx**  
**3-seater terminal right / left**  
**Batard 3 places droit/gauche**

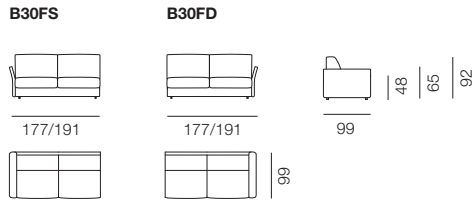

**Divano 3 posti**  
**Sofa 3 seaters**  
**Canapé 3 places**

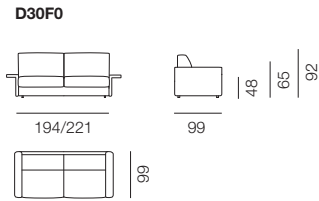

**Terminale 3 posti letto dx/sx**  
**3-seater terminal with bed right / left**  
**Batard 3 places lit droit/gauche**

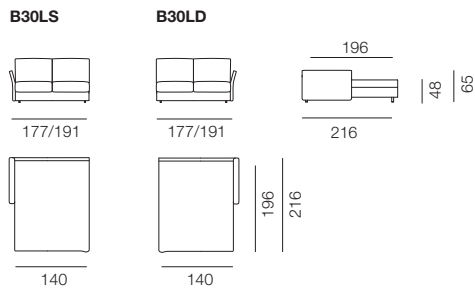

**Divano 3 posti letto**  
**Sofa 3 seaters bed**  
**Canapé 3 places lit**

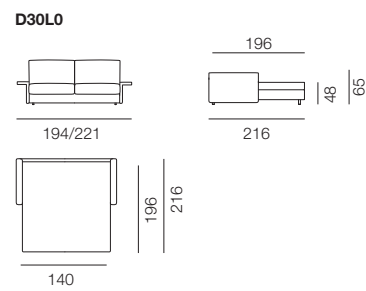

**Terminale 3 posti maxi letto dx/sx**  
**3-seater terminal maxi with bed right / left**  
**Batard 3 places lit maxi droit/gauche**

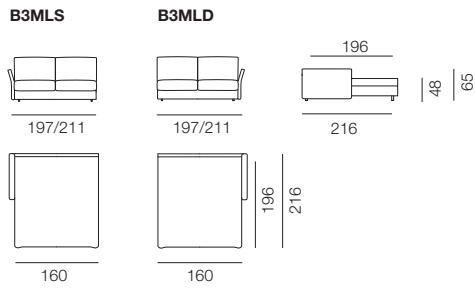

**Divano 3 posti maxi letto**  
**Sofa 3 seaters maxi bed**  
**Canapé 3 places maxi lit**

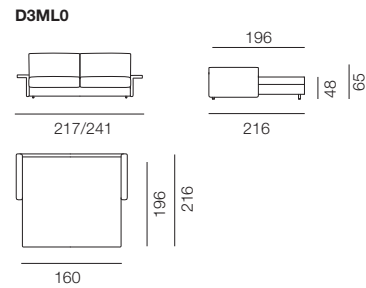

**Chaise longue contenitore dx/sx**  
**Chaise longue with box right / left**  
**Chaise longue droite / gauche avec coffre**

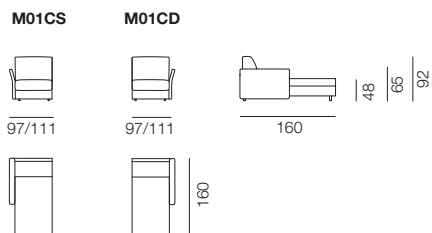





# MANGO

designed by Andrea Arena

Mango, un comodo divano che ti fa risparmiare spazio. Il divano usato di giorno per tante attività, la sera si trasforma all'istante in un letto accogliente.

Mango, a comfortable sofa that saves space. The sofa used during the day for many activities, in the evening instantly turns into a cozy bed.

Mango, un canapé confortable qui fait gagner de la place. Le canapé est utilisé pendant la journée pour de nombreuses activités, puis le soir il se transforme instantanément en un lit confortable.

— **1 Mango:**  
tessuto Bazar col.17  
fabric Bazar col.17  
tissu Bazar col.17

— **2 Gemini:**  
tessuto Leida col.28  
fabric Leida col.28  
tissu LLeida col.28



1



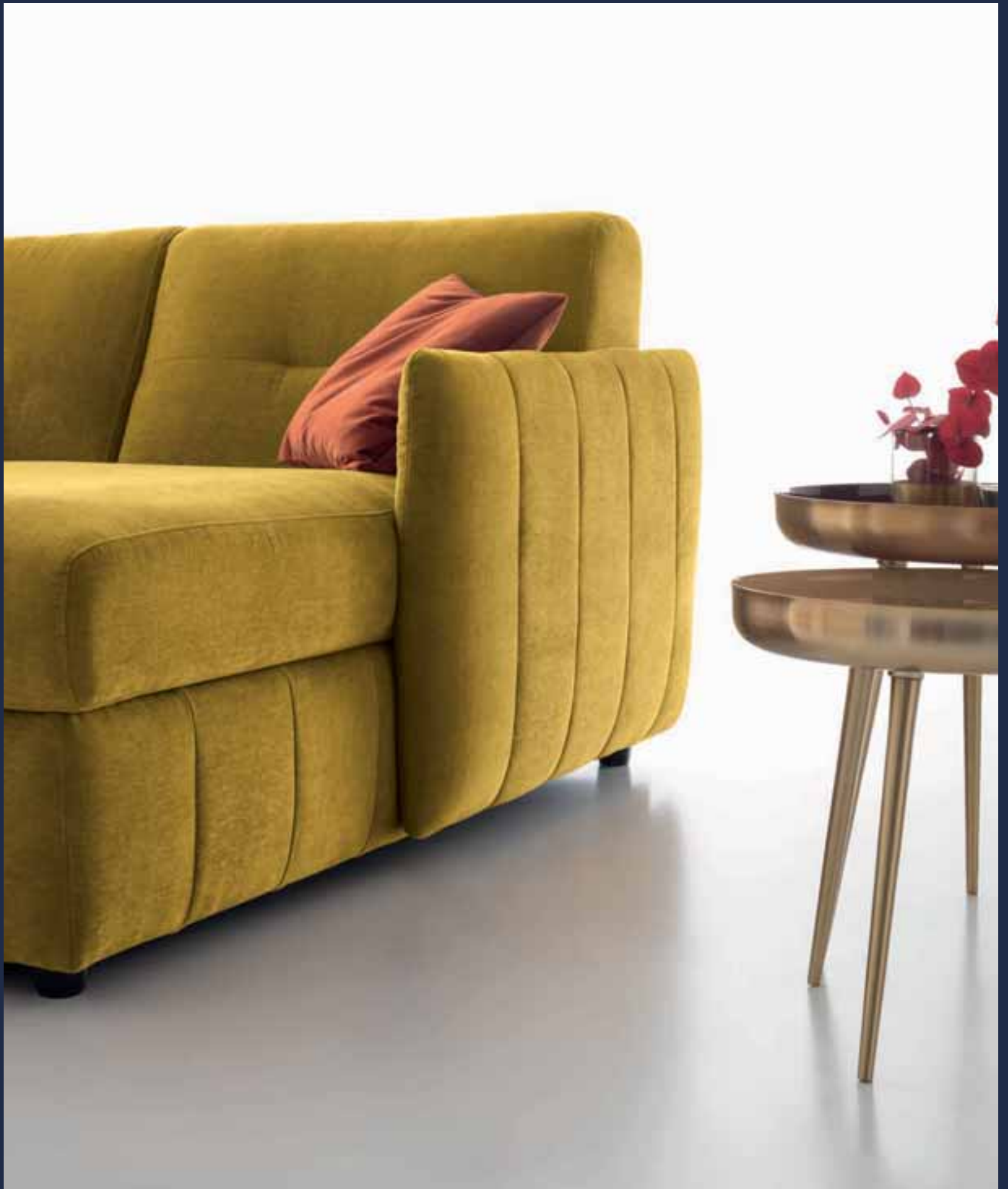











# MANGO

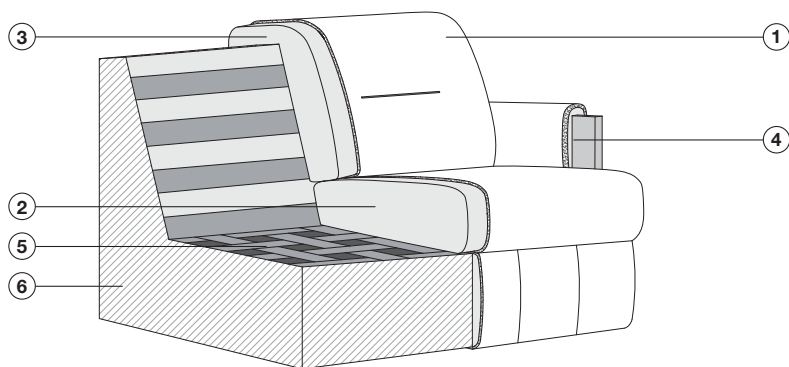

- 1 / Rivestimento
- 2 / Imbottitura seduta: poliuretano espanso 30 kg/m<sup>3</sup> ricoperto con resinato accoppiato
- 3 / Imbottitura schienale: poliuretano espanso SUPER SOFT ricoperto con resinato accoppiato
- 4 / Imbottitura bracciolo: poliuretano espanso ricoperto con resinato accoppiato
- 5 / Sistema di molleggio: cinghie elastiche incrociate nella versione fissa
- 6 / Struttura portante: legno massello e multistrato con parti in agglomerato
- 7 / Piedi a spillo (non visibili)

- 1 / Sofa covering
- 2 / Seat padding: expanded polyurethane 30 kg/m<sup>3</sup> covered with coupled wadding resin
- 3 / Backrest padding: expanded polyurethane 30 kg/m<sup>3</sup> - 18 kg/m<sup>3</sup> SUPER SOFT covered with resin wadding
- 4 / Armrest padding: expanded polyurethane covered with coupled wadding resin
- 5 / Springing: suspension with elastic crossing belts in the fixed version
- 6 / Structure: solid wood and multilayer frame with parts in plywood and particle board
- 7 / Cylindrical feet (not visible)

- 1 / Revêtement
- 2 / Rembourrage assise: polyuréthane expansé 30 Kg/m<sup>3</sup> recouvert en résiné couplé
- 3 / Rembourrage dossier: polyuréthane expansé SUPER SOFT recouvert en résiné couplé
- 4 / Rembourrage accoudoir: polyuréthane expansé recouvert en résiné couplé
- 5 / Système de suspension: sangles élastiques entrecroisées en version fixe
- 6 / Structure portante: bois massif et panneaux agglomérés ou multicouche
- 7 / Pieds cylindriques (non visibles)

**Terminale 2 posti dx/sx**  
**2-seater terminal right/left**  
**Batard 2 places droit/gauche**

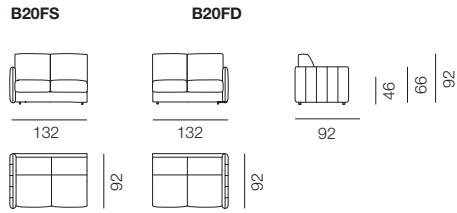

**Divano 2 posti**  
**Sofa 2 seaters**  
**Canapé 2 places**

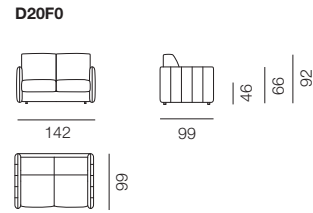

**Terminale 3 posti dx/sx**  
**3-seater terminal right/left**  
**Batard 3 places droit/gauche**

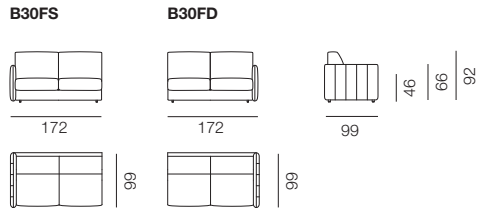

**Divano 3 posti**  
**Sofa 3 seaters**  
**Canapé 3 places**

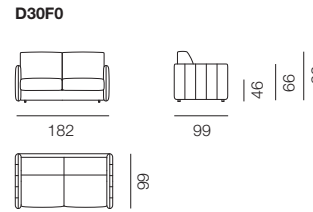

**Divano 3 posti maxi dx/sx**  
**Sofa 3 seaters maxi right/left**  
**Canapé 3 places maxi droit/gauche**

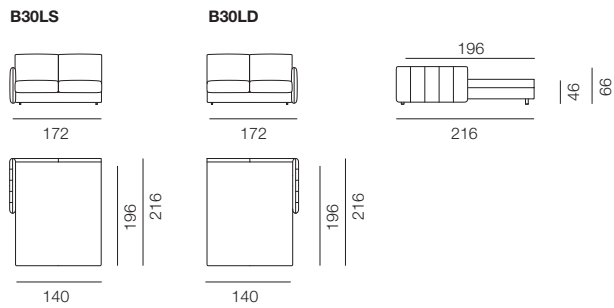

**Divano 3 posti letto**  
**Sofa 3 seaters bed**  
**Canapé 3 places lit**

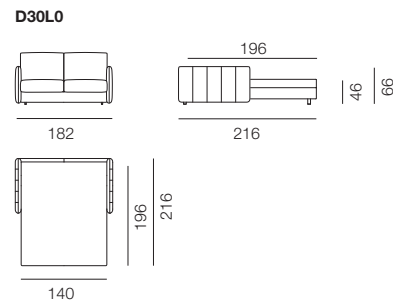

**Divano 2 posti**  
**Sofa 2 seaters**  
**Canapé 2 places**

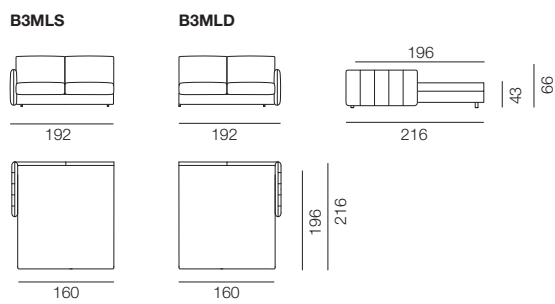

**Divano 3 posti maxi letto**  
**Sofa 3 seaters maxi bed**  
**Canapé 3 places maxi lit**

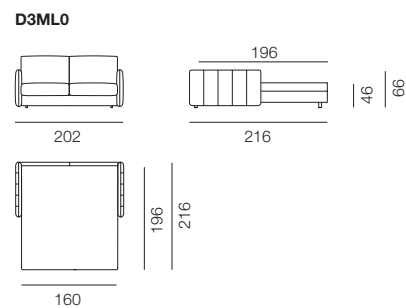

**Chaise longue contenitore dx/sx**  
**Chaise longue with box right/left**  
**Chaise longue droite / gauche avec coffre**

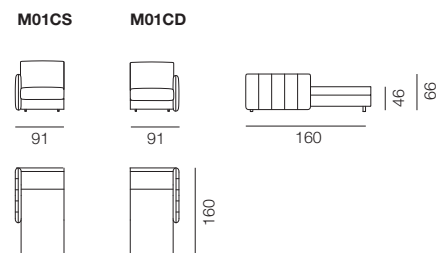





# DORICO

designed by Andrea Arena

Con il divano letto Dorico, il comfort assoluto coniuga un alto valore estetico alla funzionalità più innovativa e basterà un semplice gesto per aprire o chiudere il meccanismo.

With the Dorico sofa bed, absolute comfort combines a high aesthetic value with the most innovative functionality and a simple gesture will be enough to open or close the mechanism.

Avec le canapé-lit Dorico, un confort absolu combine une valeur esthétique élevée avec la fonctionnalité la plus innovante et un simple geste suffira pour ouvrir ou fermer le mécanisme.

— 1 Dorico:  
tessuto Leida col.57  
fabric Leida col.57  
tissu Leida col.57







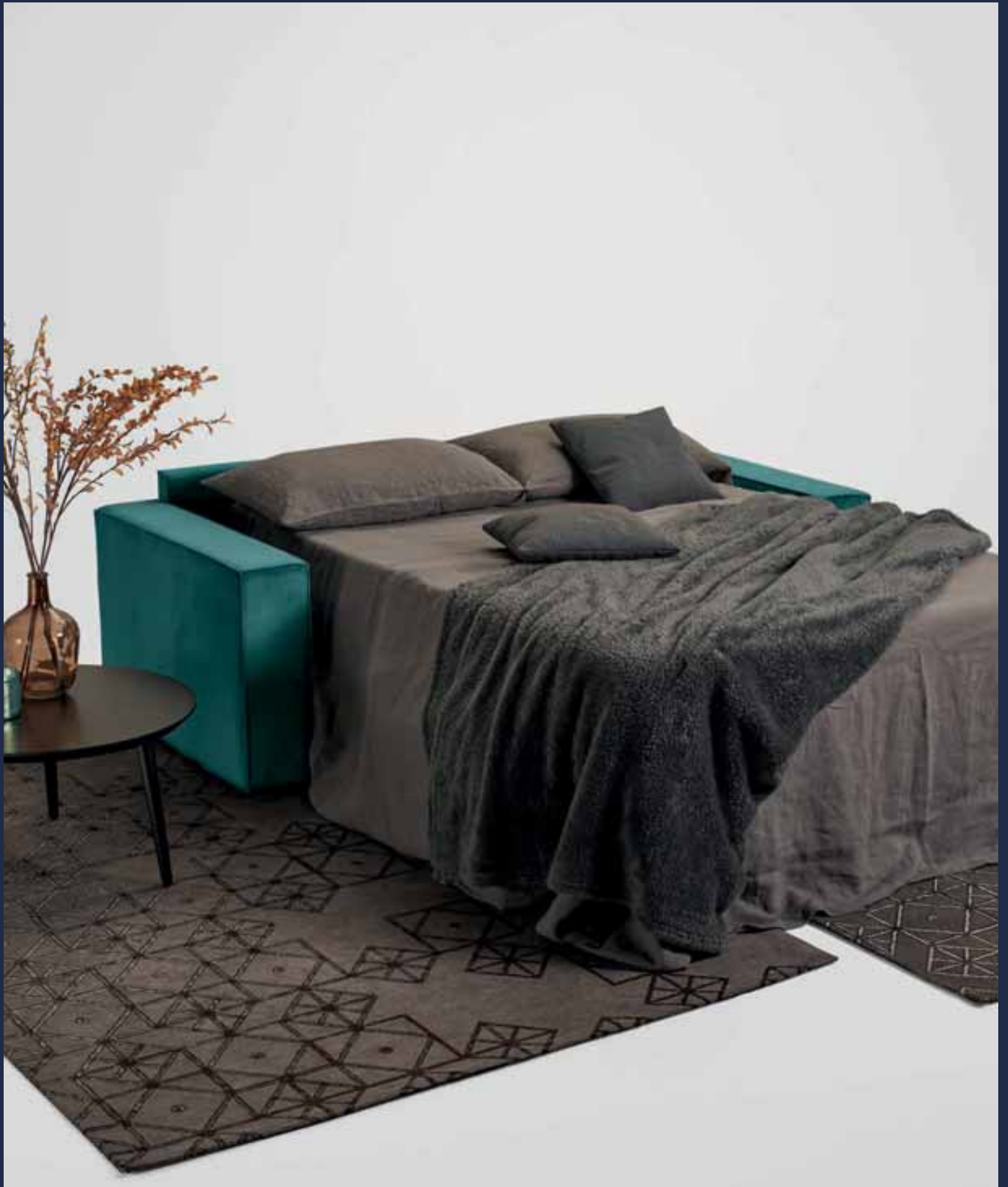



# DORICO

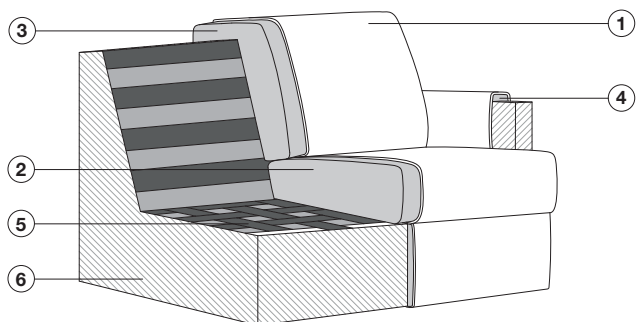
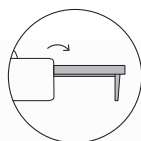

- 1 / Rivestimento
- 2 / Imbottitura seduta: poliuretano espanso 30 kg/m<sup>3</sup> ricoperto con resinato
- 3 / Imbottitura schienale: poliuretano espanso ricoperto con resinato accoppiato
- 4 / Imbottitura bracciolo: poliuretano espanso 30 kg/m<sup>3</sup>
- 5 / Sistema di molleggio: cinghie elastiche incrociate nella versione fissa
- 6 / Struttura portante: legno massello e multistrato con parti in agglomerato
- 7 / Piedi a spillo (non visibili)

- 1 / Sofa covering
- 2 / Seat padding: expanded polyurethane 30 kg/m<sup>3</sup> covered with wadding resin
- 3 / Backrest padding: expanded polyurethane covered with coupled wadding resin
- 4 / Armrest padding: expanded polyurethane 30 kg/m<sup>3</sup>
- 5 / Springing: suspension with elastic crossing belts in the fixed version
- 6 / Structure: solid wood and multilayer frame with parts in plywood and particle board
- 7 / Cylindrical feet (not visible)

- 1 / Revêtement
- 2 / Rembourrage assise: polyuréthane expansé 30 Kg/m<sup>3</sup> recouvert en résiné
- 3 / Rembourrage dossier: polyuréthane expansé recouvert en résiné couplé
- 4 / Rembourrage accoudoir: polyuréthane expansé 30 kg/m<sup>3</sup>
- 5 / Système de suspension: sangles élastiques entrecroisées en version fixe
- 6 / Structure portante: bois massif et panneaux agglomérés ou multicouche
- 7 / Pieds cylindriques (non visibles)

**Divano 2 posti**  
**Sofa 2 seaters**  
**Canapé 2 places**

**D20F0**

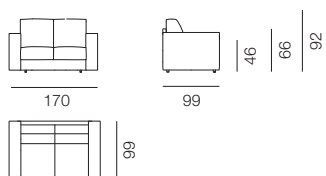

**Divano 2,5 posti**  
**Sofa 2,5 seaters**  
**Canapé 2,5 places**

**D25L0**

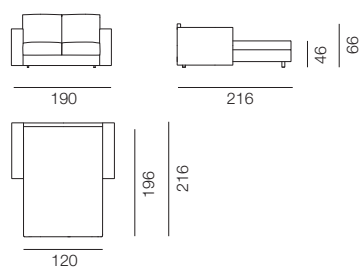

**Divano 3 posti**  
**Sofa 3 seaters**  
**Canapé 3 places**

**D30F0**

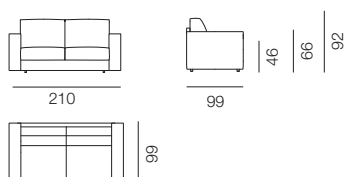

**Divano 3 posti letto**  
**Sofa 3 seaters bed**  
**Canapé 3 places lit**

**D30L0**

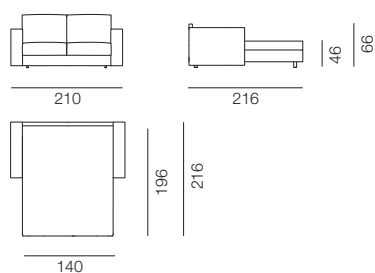

**Divano 3 posti maxi letto**  
**Sofa 3 seaters maxi bed**  
**Canapé 3 places maxi lit**

**D3ML0**

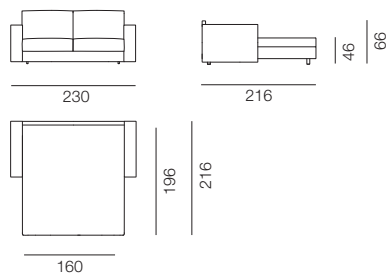



# AMANDINE

designed by Andrea Arena

Un divano che fa della semplicità e della linearità del design i suoi tratti distintivi. Un equilibrio raffinato tra essenzialità e comoda accoglienza per conquistare ogni ambiente, essendone protagonista. La sua grande qualità costruttiva garantisce la massima comodità di giorno ma anche la possibilità di trasportarci in un mondo di sogni quando si apre in un grande letto.

A sofa that stands out for its simple, linear design. A refined balance between essential design and soft comfort to become the star of any setting. Its construction quality ensures the utmost comfort by day and takes you to a world of wonderful dreams when it opens into a large bed for the night.

Un canapé qui fait de sa simplicité et de la linéarité du design ses traits principaux. Un équilibre raffiné entre essentialité et accueil confortable pour conquérir chaque ambiance, en étant le protagoniste. Sa structure importante garantit un confort élevé durant la journée mais nous transporte aussi dans le monde des rêves lorsqu'il devient un grand lit.

— 1 Amandine:  
tessuto Ecosuede col.5  
fabric Ecosuede col.5  
tissu Ecosuede col.5











# AMANDINE

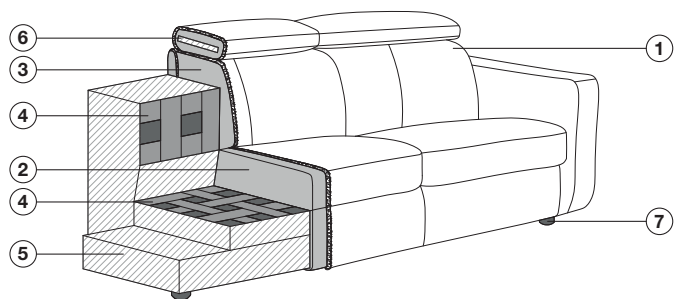

- 1 / Rivestimento
- 2 / Imbottitura seduta: poliuretano espanso 30 kg/m<sup>3</sup> ricoperto con resinato accoppiato
- 3 / Imbottitura schienale: poliuretano espanso
- 4 / Sistema di molleggio: cinghie elastiche incrociate
- 5 / Struttura portante: legno massello e multistrato con parti in agglomerato
- 6 / Poggiatesta: scheletro in legno e imbottitura in poliuretano espanso
- 7 / Piedi in ABS antiscivolo

- 1 / Sofa covering
- 2 / Seat padding: expanded polyurethane 30 kg/m<sup>3</sup> covered with coupled wadding resin
- 3 / Backrest padding: expanded polyurethane
- 4 / Springing: suspension with elastic crossing belts
- 5 / Structure: solid wood and multilayer frame with parts in plywood and particle board
- 6 / Headrest: wood frame and expanded polyurethane
- 7 / Antislip ABS feet

- 1 / Revêtement
- 2 / Rembourrage assise: polyuréthane expansé 30 Kg/m<sup>3</sup> recouvert en résiné couplé
- 3 / Rembourrage dossier: polyuréthane expansé
- 4 / Système de suspension: sangles élastiques entrecroisées
- 5 / Structure portante: bois massif et panneaux agglomérés ou multicouche
- 6 / Appuie-tête: structure en bois et rembourrage en polyuréthane expansé
- 7 / Pieds ABS antidérapant

**Bracciolo B**  
**Armrest B**  
**Accoudoir B**



**Divani**  
**Sofas**  
**Canapés**

**D20F0**

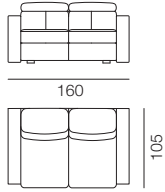

**D25F0**

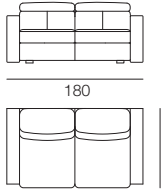

**D30F0**

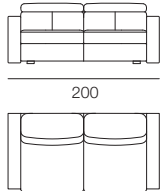

**D3MF0**

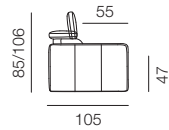
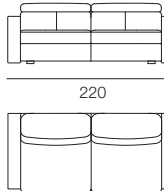

**Elementi terminali**  
**Terminal elements**  
**Batards**

**B25LS**

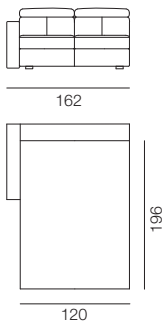

**B25LD**

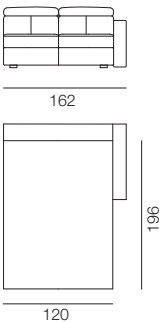

**B30LS**

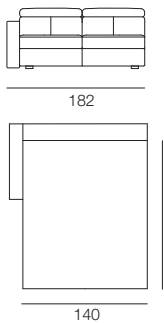

**B30LD**

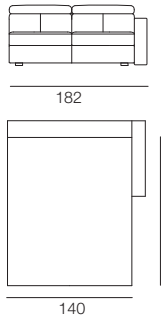

**B3MLS**

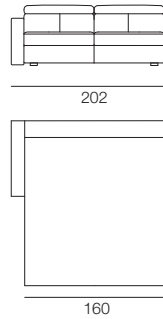

**B3MLD**

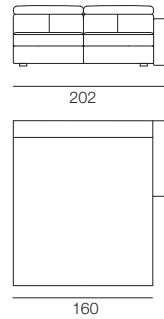

AMANDINE

**Divani letto**  
**Sofas with bed**  
**Canapés-lit**

**D10L0**

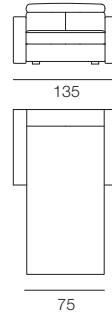

**D25L0**

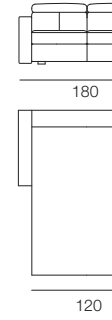

**D30L0**

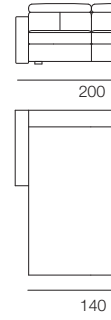

**D3ML0**

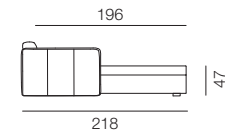
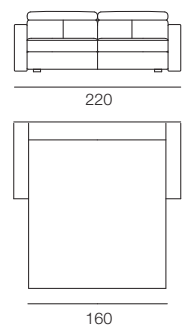

**Chaise longue contenitore**  
**Chaise longue with case**  
**Chaises longues avec coffre**

**M01CS**

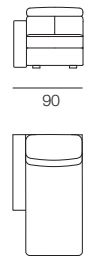

**M01CD**

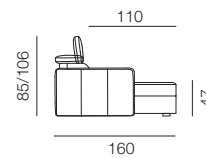
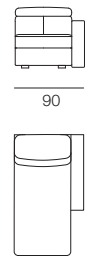

**Poltrona**  
**Armchair**  
**Fauteuil**

**D10F0**

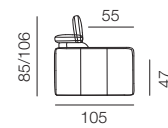
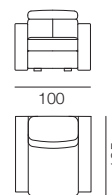





**Bracciolo C**  
**Armrest C**  
**Accoudoir C**



**Divani**  
**Canapés**  
**Sofas**

**D20F0**

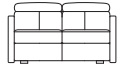

138

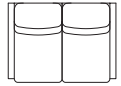

105

**D25F0**

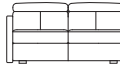

158

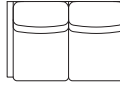

105

**D30F0**

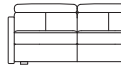

178

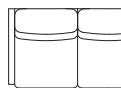

105

**D3MF0**

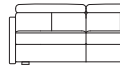

198

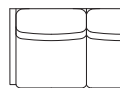

105

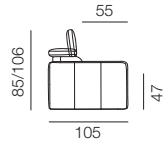

**Elementi terminali**  
**Terminal elements**  
**Batards**

**B25LS**

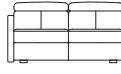

151

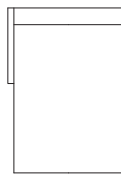

196

218

120

**B25LD**

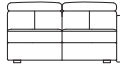

151

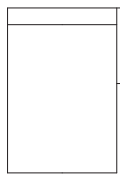

196

218

120

**B30LS**

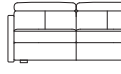

171

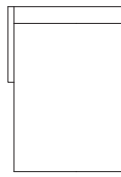

196

218

140

**B30LD**



171



196

218

140

**B3MLS**



191

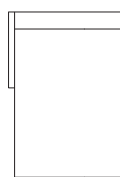

196

218

160

**B3MLD**

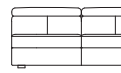

191



196

218

160

AMANDINE

**Divani letto**  
**Sofas with bed**  
**Canapés-lit**

**D10L0**

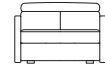

113

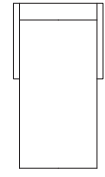

196

218

75

**D25L0**

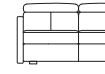

158

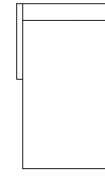

196

218

120

**D30L0**

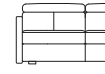

178

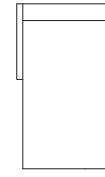

196

218

140

**D3ML0**

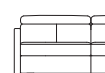

198

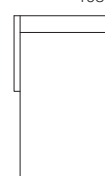

196

218

160

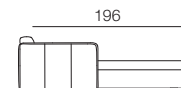

218

**Chaise longue contenitore**  
**Chaise longue with case**  
**Chaises longues avec coffre**

**M01CS**



83

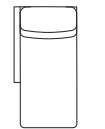

160

**M01CD**



83

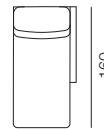

160

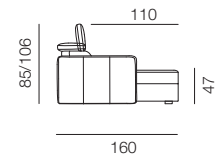

**Poltrona**  
**Armchair**  
**Fauteuil**

**D10F0**



78

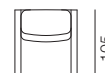

105

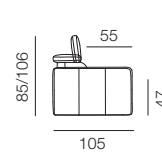



# TEXAS

designed by Andrea Arena

Volumi nei volumi: le linee del comfort disegnano una pratica idea di efficienza giocando con la multifunzionalità degli spazi contenuti. Texas racconta storie di artigiana maestria interpretando il giorno con una dolce morbidezza e regalando alla notte sogni eterei e raffinati.

Volumes within volumes. Texas expresses a practical idea of efficiency by playing with multipurpose spaces. This sofa is the result of craftsmanship and artistry that ensures comfortable softness by day and ethereal, sophisticated dreams by night.

Des volumes dans les volumes : les lignes du confort dessinent une idée pratique d'efficacité en jouant avec la fonctionnalité des espaces contenus. Le Texas raconte les histoires d'un savoir-faire artisanal en interprétant le jour par une douce souplesse et en offrant aux nuits des rêves éthérés et raffinés.

— 1 Texas:  
tessuto Ecosuede col.5  
fabric Ecosuede col.5  
tissu Ecosuede col.5



①







# TEXAS

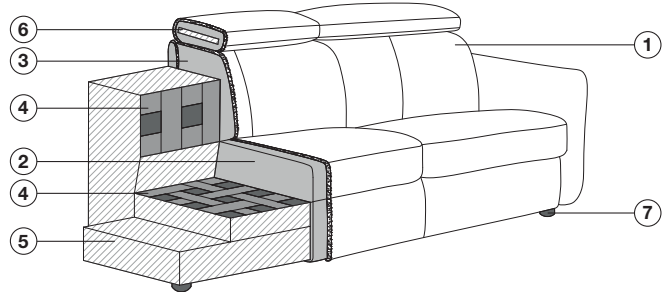

- 1 / Rivestimento
- 2 / Imbottitura seduta: poliuretano espanso 30 kg/m<sup>3</sup> ricoperto con resinato accoppiato
- 3 / Imbottitura schienale: poliuretano espanso
- 4 / Sistema di molleggio: cinghie elastiche incrociate
- 5 / Struttura portante: legno massello e multistrato con parti in agglomerato
- 6 / Poggiatesta: scheletro in legno e imbottitura in poliuretano espanso
- 7 / Piedi in ABS antiscivolo

- 1 / Sofa covering
- 2 / Seat padding: expanded polyurethane 30 kg/m<sup>3</sup> covered with coupled wadding resin
- 3 / Backrest padding: expanded polyurethane
- 4 / Springing: suspension with elastic crossing belts
- 5 / Structure: solid wood and multilayer frame with parts in plywood and particle board
- 6 / Headrest: wood frame and expanded polyurethane
- 7 / Antislip ABS feet

- 1 / Revêtement
- 2 / Rembourrage assise: polyuréthane expansé 30 Kg/m<sup>3</sup> recouvert en résiné couplé
- 3 / Rembourrage dossier: polyuréthane expansé
- 4 / Système de suspension: sangles élastiques entrecroisées
- 5 / Structure portante: bois massif et panneaux agglomérés ou multicouche
- 6 / Appuie-tête: structure en bois et rembourrage en polyuréthane expansé
- 7 / Pieds ABS antidérapant

**Bracciolo  
Armrest  
Accoudoir**

15



**Divani  
Sofas  
Canapés**

**D20F0**

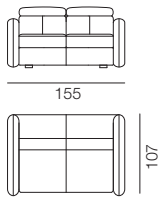

**D30F0**

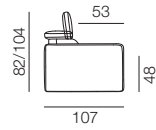
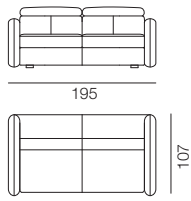

**Chaise longue contenitore  
Chaise longue with case  
Chaise longue avec coffre**

**M01CS**

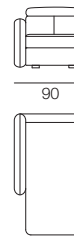

**M01CD**

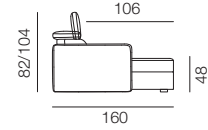
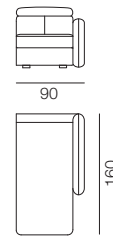

**Divani letto  
Sofas with bed  
Canapés-lit**

**D25L0**

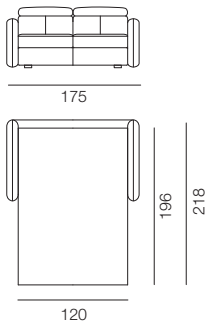

**D30L0**

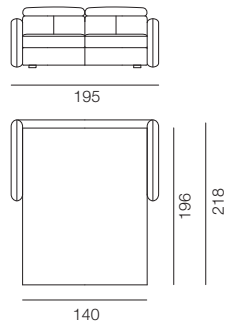

**D3ML0**

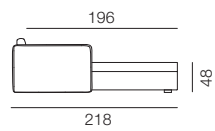
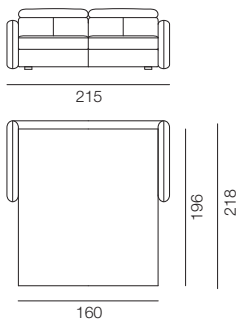

**Elementi terminali  
Terminal elements  
Batards**

**B30LS**

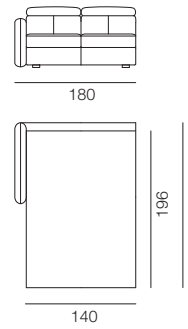

**B30LD**

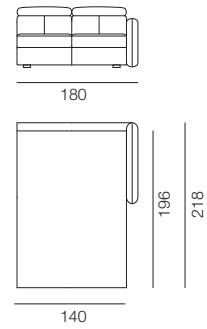



# EASY \_ CHAIRS

238

Celine



244

Gea



250

Dixi



258

Alex



Curve morbide e allo stesso tempo assolutamente contemporanee. Che sia il living o un open space la poltrona è perfetta per trovare posto in un angolo felice e raccolto, dove leggere, ascoltare musica o semplicemente riposarsi.

Soft curves and at the same time absolutely contemporary. Whether it's the living room or an open space the armchair is perfect to find a place in a happy and cozy corner, where to read, listen to music or just rest.

Des courbes douces et en même temps absolument contemporaines. Que ce soit dans le salon ou dans un espace ouvert, ces fauteuils sont parfaits dans un coin heureux et confortable, où lire, écouter de la musique, ou se reposer.





# CELINE

designed by Andrea Arena

Forme curve dall'aspetto retrò esaltate dalla totale assenza di spigoli e dalla morbidezza del tessuto per offrire stimoli sensoriali impareggiabili. Una poltrona leggera dall'eleganza dinamica e sofisticata, dove poter trovare spazio per concedersi al pensiero e alla lettura in un soffice e rilassante abbraccio.

Curved shapes with a vintage twist emphasised by the softness of the fabric and the absence of edges to provide an unrivalled sensory experience. A lightweight armchair that stands out for its dynamic and sophisticated elegance. A soft and relaxing embrace in which to enjoy your thoughts or a good book.

Des formes courbées à l'aspect rétro exaltées par l'absence totale d'angles et par la douceur du tissu pour offrir des joies sensorielles incomparables. Un fauteuil léger, à l'élégance dynamique et sophistiquée, où pouvoir trouver une place pour se dédier à la réflexion et à la lecture dans une étreinte douce et apaisante.

— 1 Celine:

tessuto Leida col.57 / Leida col.53 / metallo M310 antracite  
fabric Leida col.57 / Leida col.53 / Anthracite metal M310  
tissu Leida col.57 / Leida col.53 / métal M310 Anthracite





— 1 Celine:  
tessuto Frida col.07 / Gros Grain col.88 amaranto / metallo bianco 306  
fabric Frida col.07 / Gros Grain col.88 amaranto / white metal 306  
tissu Frida col.07 / Gros Grain col.88 amaranto / métal blanc 306







Poltrona  
Armchair  
Fauteuil

D10F0

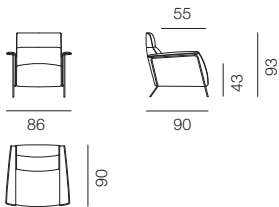

CELINE

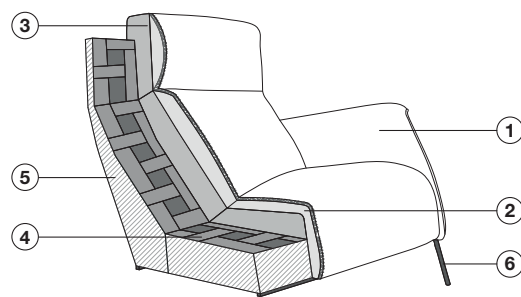

Finiture metallo  
Metal finishes  
Finitions métalliques



306



M312



M310

1 / Rivestimento  
2 / Imbottitura seduta: poliuretano espanso HT 35 kg/m<sup>3</sup> ricoperto con resinato accoppiato  
3 / Imbottitura schienale: poliuretano espanso a densità differenziata  
4 / Sistema di molleggio: cinghie elastiche incrociate  
5 / Struttura portante: metallo, legno massello e multistrato con parti in agglomerato  
6 / Piedi in metallo

1 / Sofa covering  
2 / Seat padding: expanded polyurethane HT 35 kg/m<sup>3</sup> covered with coupled wadding resin  
3 / Backrest padding: expanded polyurethane in variable density  
4 / Springing: suspension with elastic crossing belts  
5 / Structure: metal, solid wood and multilayer frame with parts in plywood and particle board  
6 / Metal feet

1 / Revêtement  
2 / Rembourrage assise: polyuréthane expansé HT 35 Kg/m<sup>3</sup> recouvert en résiné couplé  
3 / Rembourrage dossier: polyuréthane expansé multi-densité  
4 / Système de suspension: sangles élastiques entrecroisées  
5 / Structure portante: bois massif et panneaux agglomérés ou multicouche  
6 / Pieds en métal



# GEA

designed by Andrea Arena

Linee decise che scolpiscono le forme nello spazio e richiamano le audaci geometrie del design degli anni Venti e Trenta. Reinterpretare forme vestendole di materia e colore.

Bold lines that sculpt the shapes in the space and recall the bold geometries of the design of the twenties and thirties. Reinterpreting shapes by dressing them in material and color.

Des lignes audacieuses qui sculptent les formes dans l'espace et rappellent les géométries audacieuses du design des années vingt et trente. Réinterpréter les formes en les habillant de matière et de couleur.

— 1 Gea:

tessuto Leida col.49 / tessuto Frise col.402  
fabric Leida col.49 / fabric Frise col.402  
tissu Leida col.49 / tissu Frise col.402



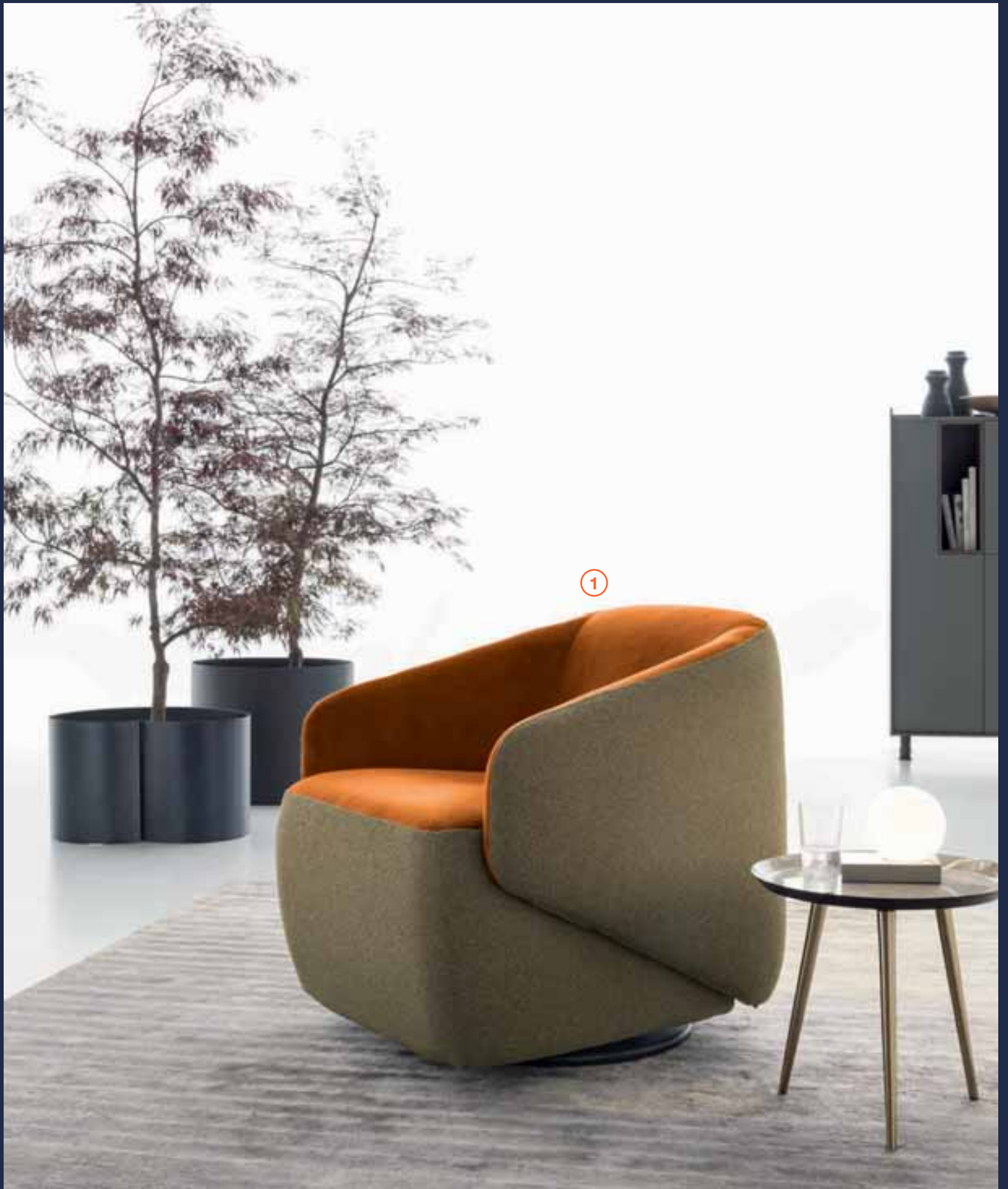





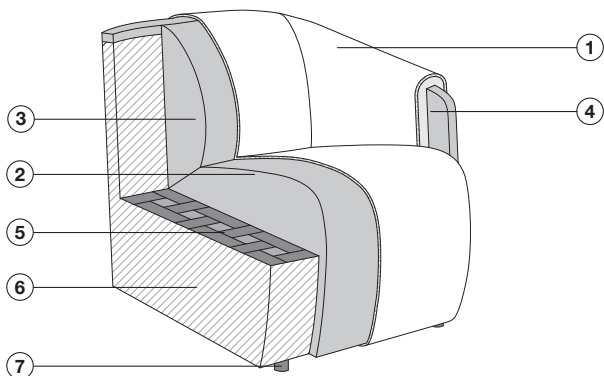

- 1 / Rivestimento
- 2 / Imbottitura seduta: poliuretano espanso 30 kg/m<sup>3</sup> ricoperto con resinato accoppiato
- 3 / Imbottitura schienale: poliuretano espanso con resinato accoppiato
- 4 / Imbottitura bracciolo: poliuretano espanso con resinato accoppiato
- 5 / Sistema di molleggio: cinghie elastiche incrociate
- 6 / Struttura portante: legno massello e multistrato con parti in agglomerato
- 7 / Piedi in ABS antiscivolo, disponibile con basamento girevole

- 1 / Sofa covering
- 2 / Seat padding: expanded polyurethane 30 kg/m<sup>3</sup> covered with coupled wadding resin
- 3 / Backrest padding: expanded polyurethane covered with coupled wadding resin
- 4 / Armrest padding: expanded polyurethane covered with coupled wadding resin
- 5 / Springing: suspension with elastic crossing belts
- 6 / Structure: solid wood and multilayer frame with parts in plywood and particle board
- 7 / Antislip ABS feet, available with swivel base

- 1 / Revêtement
- 2 / Rembourrage assise: polyuréthane expansé 30 Kg/m<sup>3</sup> recouvert en résiné couplé
- 3 / Rembourrage dossier: polyuréthane expansé recouvert en résiné couplé
- 4 / Rembourrage accoudoir: polyuréthane expansé recouvert en résiné couplé
- 5 / Système de suspension: sangles élastiques entrecroisées
- 6 / Structure portante: bois massif et panneaux agglomérés ou multicouche
- 7 / Pieds ABS antidérapant, disponible avec base pivotante

**Poltrona  
Armchair  
Fauteuil**

D10F0

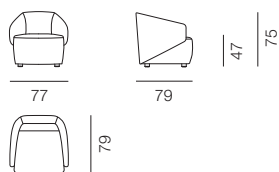

GEA

**Poltrona girevole  
Armchair with swivel base  
Fauteuil pivotant**

D10G0

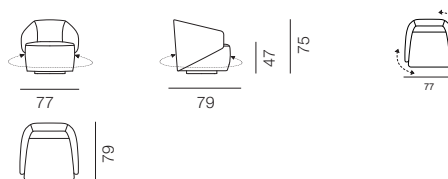



# DIXI

designed by Andrea Arena

Forme casual, una fusione tra formale e informale, irrispettosa delle tendenze contemporanee ma con una memoria delle linee, materiali e colori che interpretano e rielaborano un'elegante estetica.

Casual shapes, a fusion between formal and informal, disrespectful of contemporary trends but with a memory of lines, materials and colors that interpret and rework an elegant aesthetic.

Des formes décontractées, une fusion entre formel et informel, irrespectueux des tendances contemporaines mais avec une mémoire de lignes, de matériaux et de couleurs qui interprètent et retravaillent une esthétique élégante.

— 1 Dixi:  
tessuto Leida col.35 / tessuto Bijou col.503  
fabric Leida col.35 / fabric Bijou col.503  
tissu Leida col.35 / tissu Bijou col.503







— 1 Dixi:  
tessuto Frida col.06  
fabric Frida col.06  
tissu Frida col.06









# DIXI

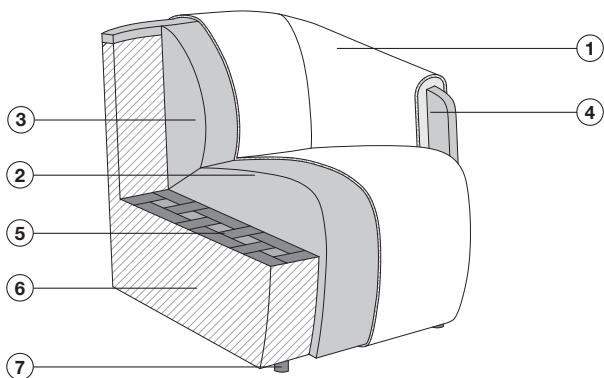

**1 / Rivestimento**  
**2 / Imbottitura seduta:** poliuretano espanso 30 kg/m<sup>3</sup> ricoperto con resinato accoppiato  
**3 / Imbottitura schienale:** poliuretano espanso con resinato accoppiato  
**4 / Imbottitura bracciolo:** poliuretano espanso con resinato accoppiato  
**5 / Sistema di molleggio:** cinghie elastiche incrociate  
**6 / Struttura portante:** legno massello e multistrato con parti in agglomerato  
**7 / Piedi in ABS antiscivolo, disponibile con basamento girevole**

**1 / Sofa covering**  
**2 / Seat padding:** expanded polyurethane 30 kg/m<sup>3</sup> covered with coupled wadding resin  
**3 / Backrest padding:** expanded polyurethane covered with coupled wadding resin  
**4 / Armrest padding:** expanded polyurethane covered with coupled wadding resin  
**5 / Springing:** suspension with elastic crossing belts  
**6 / Structure:** solid wood and multilayer frame with parts in plywood and particle board  
**7 / Antislip ABS feet, available with swivel base**

**1 / Revêtement**  
**2 / Rembourrage assise:** polyuréthane expansé 30 Kg/m<sup>3</sup> recouvert en résiné couplé  
**3 / Rembourrage dossier:** polyuréthane expansé recouvert en résiné couplé  
**4 / Rembourrage accoudoir:** polyuréthane expansé recouvert en résiné couplé  
**5 / Système de suspension:** sangles élastiques entrecroisées  
**6 / Structure portante:** bois massif et panneaux agglomérés ou multicouche  
**7 / Pieds ABS antidérapant, disponible avec base pivotante**

## Poltrona Armchair Fauteuil

D10F0

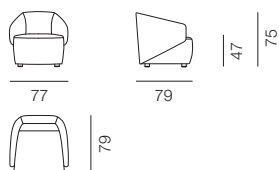

DIXI

## Poltrona girevole Armchair with swivel base Fauteuil pivotant

D10G0

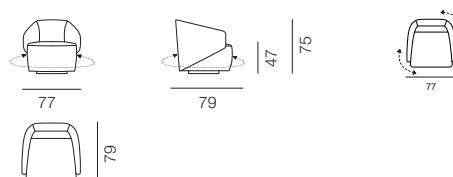





# ALEX

designed by Andrea Arena

Una poltrona che si distingue per le dimensioni contenute e per le linee morbide e rassicuranti che compongono un design classico in cui concedersi piacevoli momenti di pausa e sollievo. Il carattere è senza tempo, estremamente versatile, per donare eleganza ad ogni tipo di ambiente.

A classic armchair that stands out for its compact size and sinuous and reassuring lines, where to enjoy a break or moments of relaxation. Its timeless, extremely versatile character adds an elegant touch to any setting.

Un fauteuil qui se distingue par les dimensions contenues et par les lignes douces et rassurantes qui caractérisent un design classique où se concéder d'agréables moments de détente et de repos. Le caractère est intemporel, extrêmement versatile, pour donner élégance à chaque type d'ambiance.

— 1 Alex:  
tessuto Brezza col 114/122  
fabric Brezza col 114/122  
tissu Brezza col 114/122



# ALEX

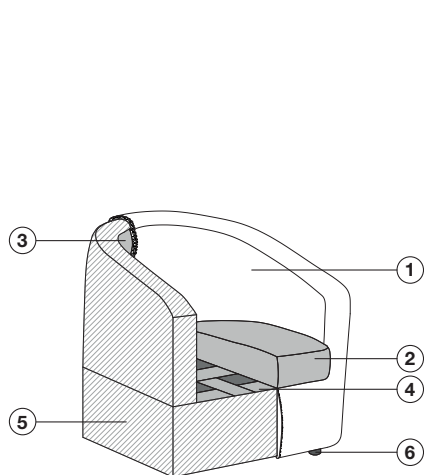

- 1 / Rivestimento
- 2 / Imbottitura seduta: poliuretano espanso 30 kg/m<sup>3</sup> ricoperto con resinato accoppiato
- 3 / Imbottitura struttura: poliuretano espanso
- 4 / Sistema di molleggio: cinghie elastiche incrociate
- 5 / Struttura portante: legno massello e multistrato con parti in agglomerato
- 6 / Piedi in ABS antiscivolo, disponibile con basamento girevole

- 1 / Sofa covering
- 2 / Seat padding: expanded polyurethane 30 kg/m<sup>3</sup> covered with coupled wadding resin
- 3 / Structure padding: expanded polyurethane
- 4 / Springing: suspension with elastic crossing belts
- 5 / Structure: solid wood and multilayer frame with parts in plywood and particle board
- 6 / Antislip ABS feet, available with swivel base

- 1 / Revêtement
- 2 / Rembourrage assise: polyuréthane expansé 30 Kg/m<sup>3</sup> recouvert en résiné couplé
- 3 / Rembourrage dossier: polyuréthane expansé
- 4 / Système de suspension: sangles élastiques entrecroisées
- 5 / Structure portante: bois massif et panneaux agglomérés ou multicouche
- 6 / Pieds ABS antidérapant, disponible avec base pivotante

## Poltrona Armchair Fauteuil

D10F0

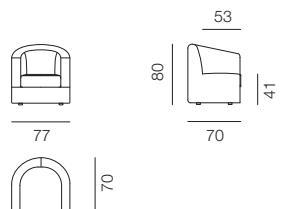

## Poltrona girevole Armchair with swivel base Fauteuil base pivotante

D10G0

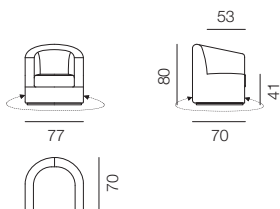

# Materials

## Metalli Metals Métals

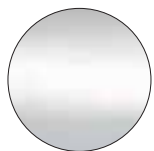

G093  
Cromo

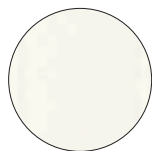

306  
Laccato bianco opaco



M312  
Laccato sabbia

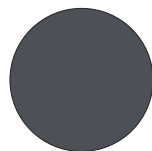

M310  
Laccato velvet antracite



55  
Laccato nero opaco



Titanio

## Gros Grain



36  
Burro

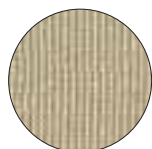

135  
Nuvola



164  
Tortora



96  
Coccio



98  
Caramel

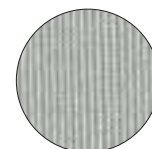

45  
Perla

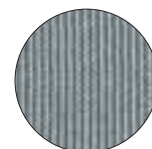

48  
Argento



42  
Acciaio

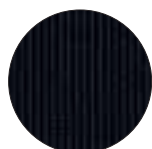

41  
Nero

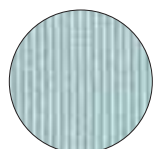

102  
Cielo

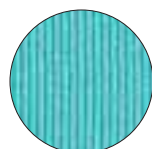

103  
Fonte

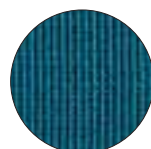

137  
Petrolio

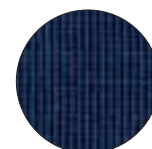

114  
Abisso

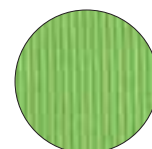

100  
Mela

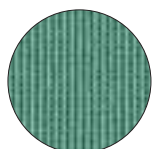

106  
Giada

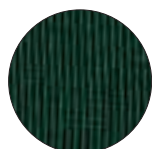

132  
Bottiglia

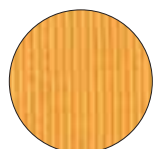

64  
Sole

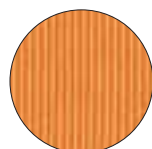

72  
Mandarino



68  
Ambra

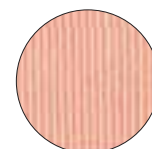

77  
Cipria

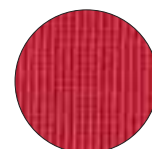

86  
Corallo

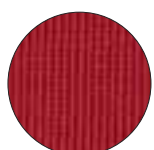

84  
Rosso



88  
Amaranto

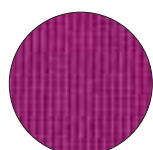

71  
Fuxia

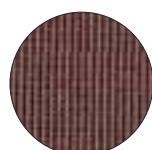

159  
Vino



158  
Mirtillo



Colori per cucitura a contrasto  
Color for stitching in contrast  
Couleurs pour coutures contrastées



0002

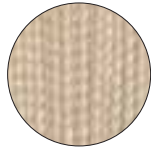

1302

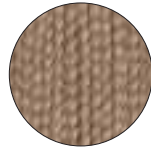

1770

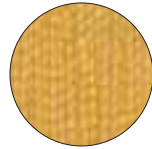

1892

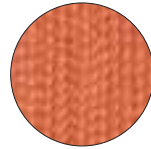

1129

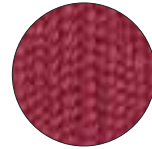

1055

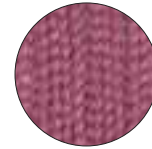

1888



7015

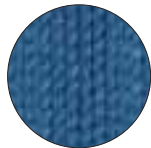

7300

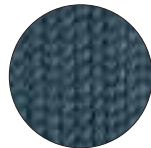

7799

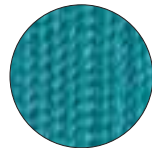

7722

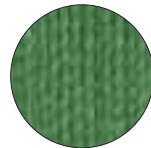

4224

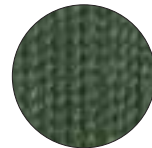

3627

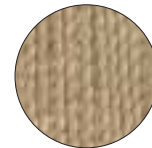

1349

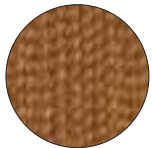

1248

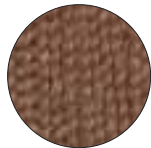

1813

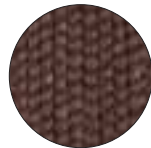

1222

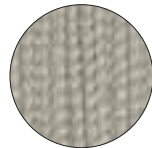

2560

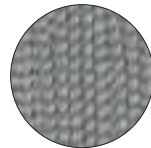

0015

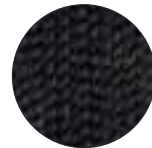

0003

# Legenda



Schienale regolabile  
Adjustable backrest  
Dossier réglable



Bracciolo regolabile  
Adjustable armrest  
Accoudoir réglable



Schienale posizionabile liberamente  
Removable backrest freely placeable  
Dossier amovible



Schienale regolabile da ogni posizione senza scatti  
Backrest adaptable from any position without jerks  
Dossier multiposition réglable sans mouvement à enclenchement



Meccanica relax  
Recliner  
Mécanique relax



Bracciolo regolabile da ogni posizione senza scatti  
Armrest adaptable from any position without jerks  
Accoudoir multiposition réglable sans mouvement à enclenchement



Testiera regolabile con microscatti  
Headrest adaptable with micro-jerks  
Appuie-tête réglable avec système de micro-enclenchement



Divano letto  
Sofa with bed  
Canapé-lit



Basamento girevole  
Swivel base  
Base pivotante

**AERRE ITALIA**  
Family Business, since 1975

**A.R srl**  
Via Nicola Sacco, 33  
47122 Forlì (FC) - Italy  
Tel. +39 0543 481529  
Fax +39 0543 481537  
www.aerreitalia.com  
info@aerreitalia.com

Le immagini, le finiture e le specifiche tecniche rappresentate sono da ritenersi puramente indicative. Possono essere apportate delle modifiche, se ritenute opportune, per migliorare in qualunque momento e senza alcun obbligo di preavviso. Si declina ogni responsabilità per danni causati dall'uso non corretto dei prodotti e per eventuali indicazioni inesatte o errori di stampa contenuti nel presente catalogo.

The photos, finishes and specifications shown are to be considered only as examples. Changes can be made at any time without any prior notice if needed. We do not accept responsibility for damage caused by improper use of the product and for any incorrect information or misprints contained in this catalogue.

Les images, finitions et spécifications techniques représentées sont à considérer comme purement indicatives. Des modifications peuvent être apportées, si elles le jugent approprié, pour s'améliorer à tout moment et sans préavis. Nous déclinons toute responsabilité pour les dommages causés par une mauvaise utilisation des produits et pour toute indication inexacte ou erreur d'impression contenue dans ce catalogue.



**ANDREA  
ARENA  
COLLEC  
\_TION**