

Ethnicraft

ACCESSORIES



collection 2023

**We create the foundations of your home
to inspire the stories of your life.**

For more than 25 years, we have been creating timeless furniture and accessories manufactured from quality materials. True to our values, we have maintained our goal to produce good design, distinguished by authenticity, simplicity and quality, as well as creativity and innovation. We rely on our unique expertise to create singular designs ready to embellish your daily life durably. We create collections for every room or space: from the furniture that defines the purpose of an area to the objects that layer it with meaning. Nothing excites us more than seeing how people love and use our products in the stories of their lives.

All of our designs are intentionally timeless. They withstand trends and associate well with different styles, and they can be passed on from one home to the next, carrying over the stories of one lifetime to another.



08 our designers

12 lookbook

64 trays

64 trays
94 valet trays
98 perfect combinations
110 tray tables

118 side tables

132 wall decor

132 mirrors
139 shelves
144 wall hangers
146 wall art

148 objects

148 bowls & boards
151 book ends
153 paper basket
154 cities & houses collection
158 sculptures

160 home textiles







160 rugs
163 cushions
170 throws
171 outdoor textiles

176 care instructions

179 our commitment



TRAY RIM COLOUR RANGE

-  **WALNUT**
This icon indicates a walnut rim.
-  **DARK WOOD**
This icon indicates a dark wood rim.
-  **LIGHT WOOD**
This icon indicates a light wood rim.
-  **BLACK METAL**
This icon indicates a black metal rim.
-  **GOLD METAL**
This icon indicates a gold metal rim.
-  **BRONZE METAL**
This icon indicates a bronze metal rim.

Please refer to our website for more information:
ethnecraft.com



ICONS YOU MIGHT COME ACROSS IN OUR PRODUCT CATALOGUE

- ⓪ **OILED**
The items marked with this icon are finished with a natural oil. Visit pages 176-179 for more information on how to take care of our oiled furniture.
- Ⓥ **VARNISHED**
The items marked with this icon are finished with varnish. Visit pages 176-179 for more information on how to take care of our varnished furniture.
- Ⓑ **BRUSHED**
The items marked with this icon are brushed. This finishing gives our furniture more depth. The rougher surface highlights the grain of the wood.
- Ⓝ **NATURAL**
The items marked with this icon come without any finishing or protective treatment applied to the surface. A natural finish enhances the inherent beauty of the material but can require more maintenance. Visit pages 176-179 for more information on how to take care of our natural wood furniture.
- Ⓒ **CONTRACT GRADE**
The items marked with this icon are EN and/or BIFMA certified.

FSC® FOREST STEWARDSHIP COUNCIL®
The items marked with this icon carry the FSC® label. Visit page 180-181 for more information on the organisation that promotes responsible management of the world's forests.



The mark of responsible forestry



The mark of responsible forestry

Please refer to our website for more information: ethnecraft.com



Dawn Sweitzer

An overflow of creative energy and a profound interest in the world of craftsmanship is what jump-started Dawn Sweitzer's journey as an artist. Her works are expressions based on travel, enriching cultures, textures within the landscape, photography, food and fashion. There is no fixed formula to how designs are conceived, they blend ideas, they reference vintage with modern. Within her beautiful North Carolina studio, Dawn works, plays and discovers in a variety of media: paint, woven textile, mirror and glass, home accessories and decor.

"My studio allows me absolute freedom to create. I walk through the door, the world outside stops, and I am completely in my element."



Carlo Massoud

The exploration of new and unknown places is key to Carlo Massoud's creations. Through these, he finds new stories to share through collaborations with local artisans and designers, creating a global narrative that stems from unique associations of people, cultures and materials. His remarkable work is the result of his relentless questioning of social, political, cultural and environmental norms, often pushing viewers to question their knowledge of the subject. This approach leads them toward thought-inducing confusion and provocation.



Alain van Havre

For Alain van Havre, inspiration is everything. Deeply connected to his environment and passionate about natural materials, he has developed an exceptional expertise for woodworking. Over the years, he has created his own visual language centred around form, a translation best described in collections such as the Bok, Graphic, PI and Stairs. He believes that for someone to connect with a design, it is important to bring it closer to nature. Over the past 20 years, Alain has played a pivotal role in influencing the Ethnicraft designs we know and love today.

our ateliers



Ethnicraft Atelier, Indonesia

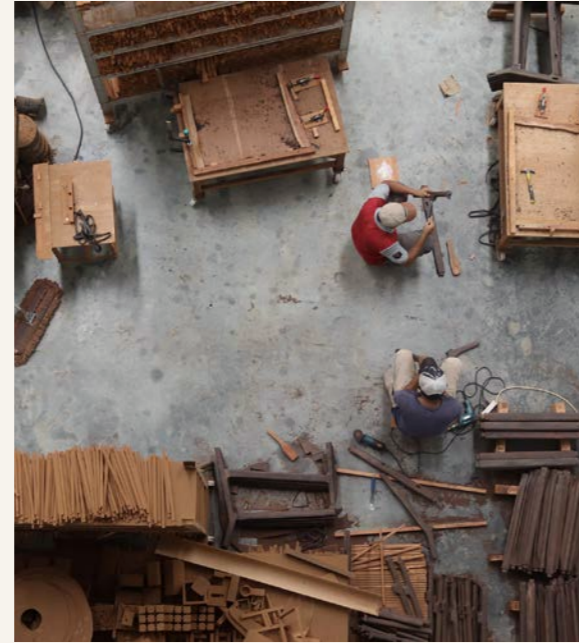

Committed to connecting the dots between great design and the intelligence of the hand, the importance of authentic craftsmanship has been a cornerstone for Ethnicraft since the very beginning. As with the workshops of the masters from years before, every collection within this specialised atelier is the result of a meticulous creation process: from the design concepts to product development, to the artisans who bring the original drawings to life.

While conserving and fostering traditional crafting methods, we work to make the most out of each and every piece, with respect for the material of wood, revered as a precious resource.

Ashtari Carpets

With an obsession for the character of handspun wool, family-owned Ashtari form the connection between past and present, craftsmanship and aesthetic with their Persian carpets. Each creation carries the traditional techniques from more than 150 years of family knowledge, delivering a richness of colour, variety of spectacular artistic patterns and quality of design. Today, with a desire to become a curator of original and extraordinary rug designs, Ashtari specialise in modern decorative carpets and select rare antique carpets, often partnering with other designers, artists, product developers, architects, textile designers and influencers. Ethnicraft's rug collection has been created in collaboration with Ashtari.

"There is a unique beauty in handspun wool that celebrates the imperfections and irregularities that appear in nature."

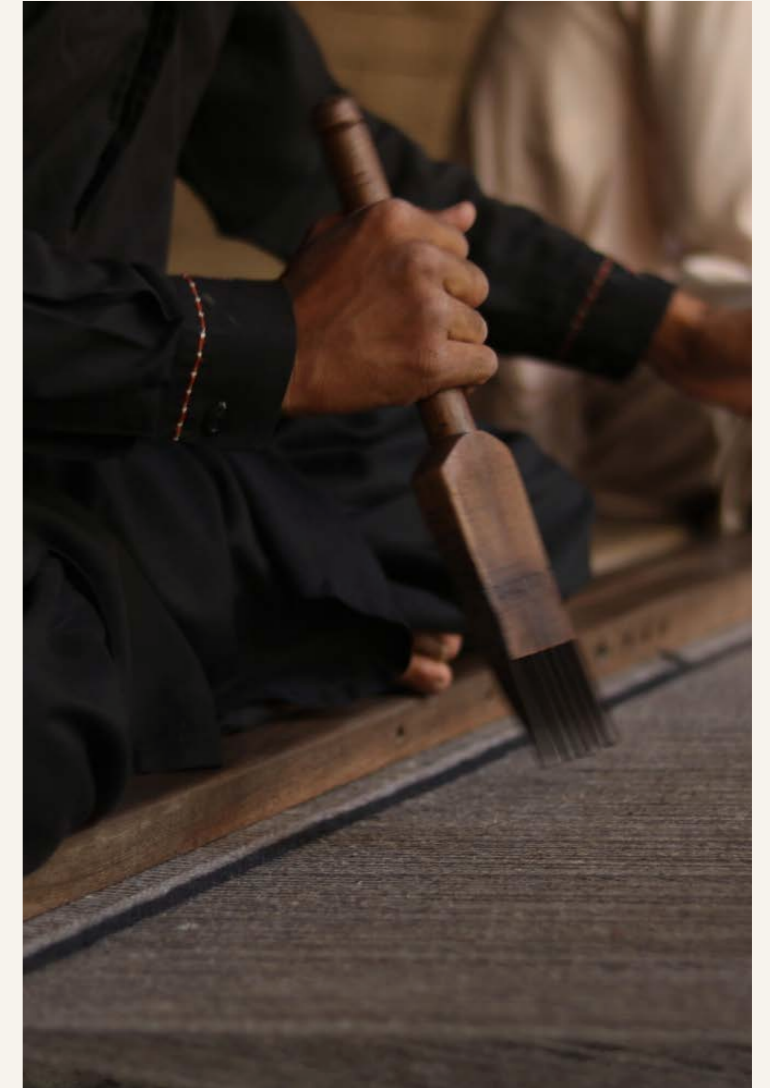



trays





**Seeking to find beauty in the not-so-perfect.
With artful and delicate organic layers creating a sense
of depth, the overall result is bold and dynamic.**





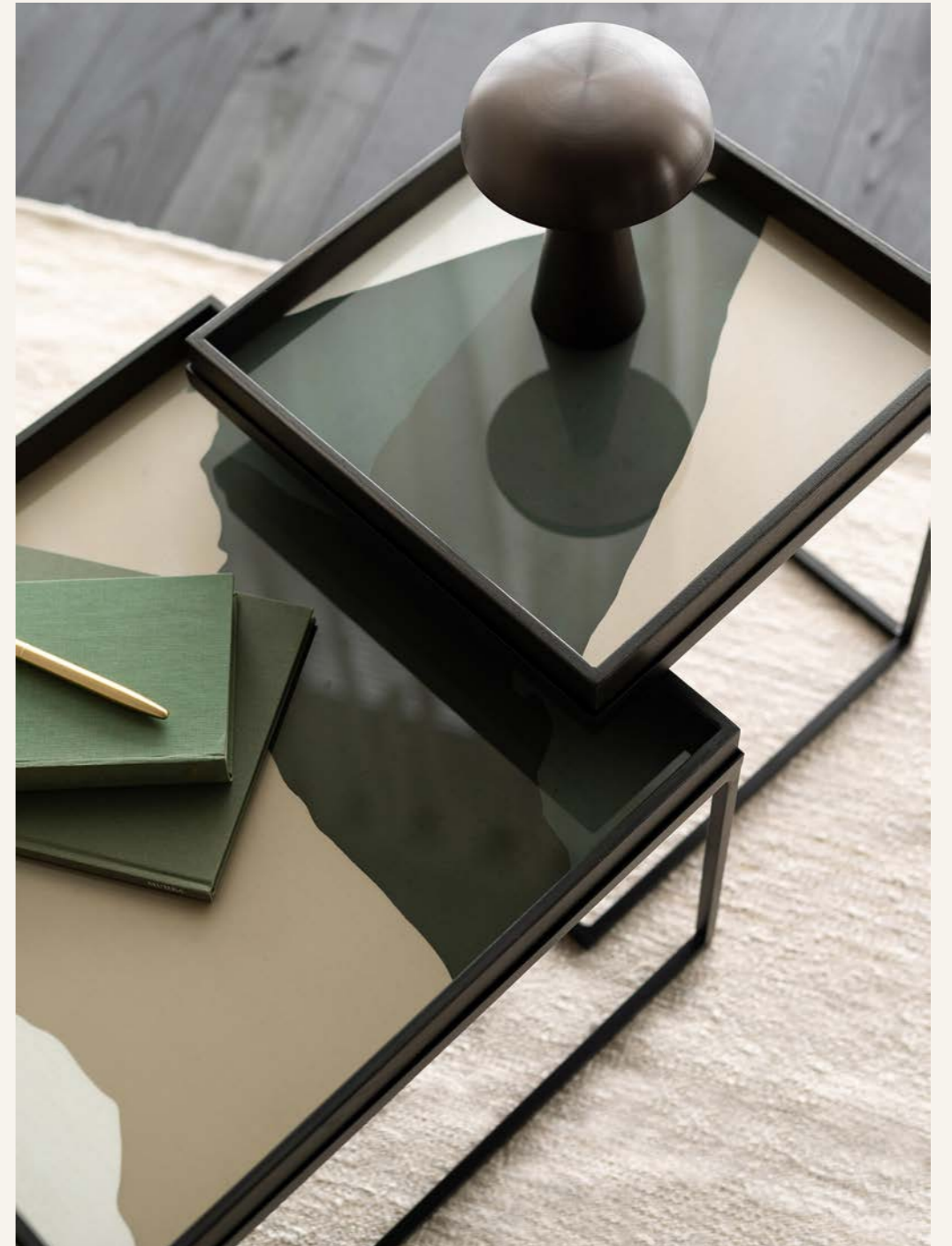





tray tables





**Designs that blend harmoniously into any space,
naturally complementing the routines of everyday life.**

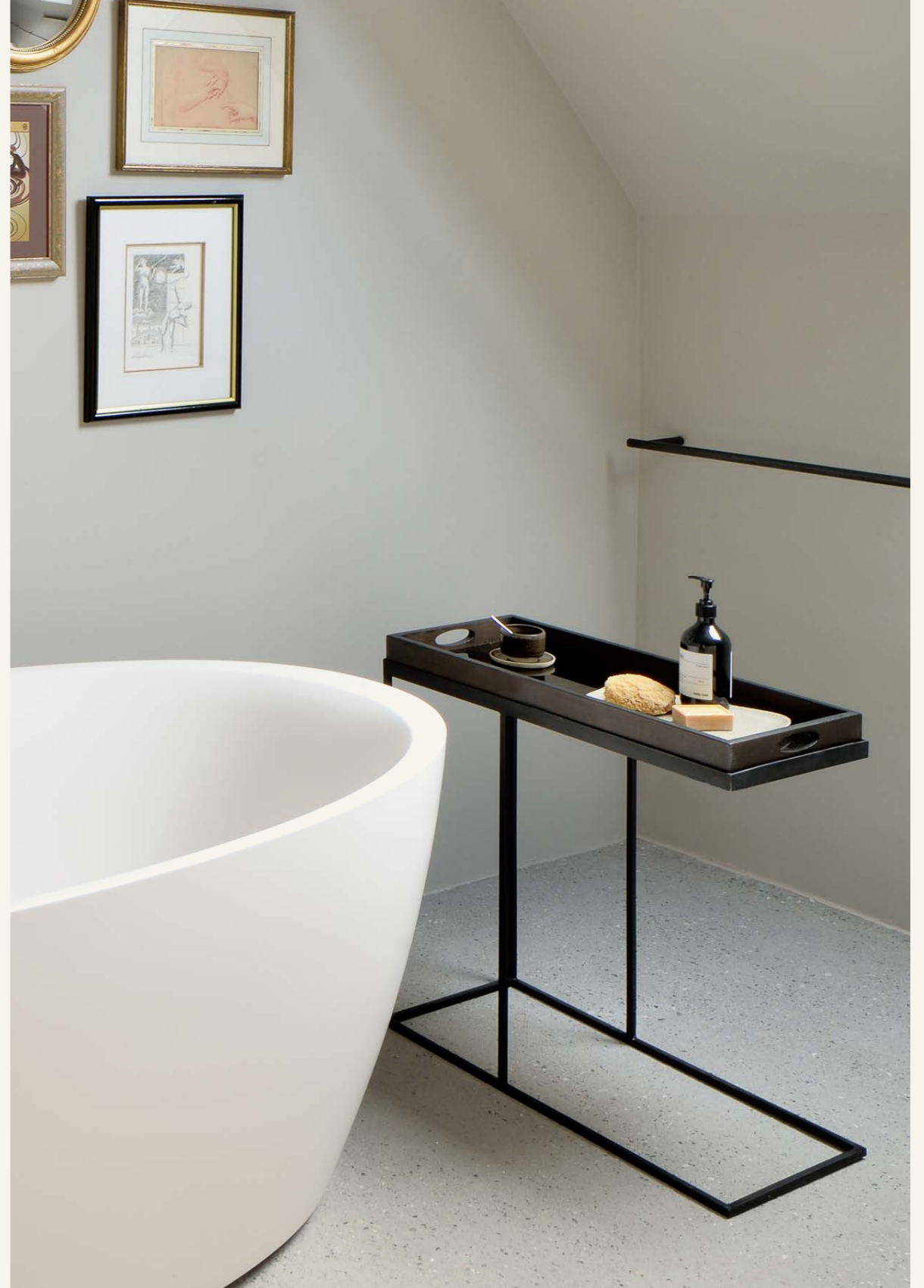





side tables









wall decor









objects

**Sculptural, decorative, artistic interpretations;
these are the masterful works of our skilled artisans.
Conversation starters and something to truly admire,
each piece carries its own unique story.**











home textiles







PRODUCT OVERVIEW

For more detailed product information,
visit our website ethnicraft.com



our novelties

THE NEWEST OF THE NEW

Alongside this catalogue of our 2023 collection, we also launch new items throughout the year.

To see the latest designs, link directly through to view our novelties online:



trays



SLICE TRAY ●
hand painted and silk-screen printed wood (V)

white - small round
20305 48 x 48 x 4 cm
19" x 19" x 1.5"



BLOSSOM TRAY ●
hand painted and silk-screen printed wood (V)

small round
20335 48 x 48 x 4 cm
19" x 19" x 1.5"



CHEVRON TRAY ●
hand painted and silk-screen printed wood (V)

graphite - small round
20932 48 x 48 x 4 cm
19" x 19" x 1.5"



BEADS TRAY ●
hand painted and silk-screen printed wood (V)

black - small round
20370 48 x 48 x 4 cm
19" x 19" x 1.5"



SLICE TRAY ●
light aged and silk-screen printed mirror
with a wooden rim

small round
20402 48 x 48 x 4 cm
19" x 19" x 1.5"





AGED TRAY ●

heavy aged mirror with a wooden rim

clear - small round

20301 48 × 48 × 4 cm
19" × 19" × 1.5"



AGED TRAY ●

heavy aged mirror with a wooden rim

bronze - small round

20403 48 × 48 × 4 cm
19" × 19" × 1.5"



AGED TRAY ●

heavy aged mirror with a wooden rim

charcoal - small round

20450 48 × 48 × 4 cm
19" × 19" × 1.5"



ORGANIC TRAY ●

hand painted glass with a wooden rim

mist gold - small round

20361 48 × 48 × 4 cm
19" × 19" × 1.5"

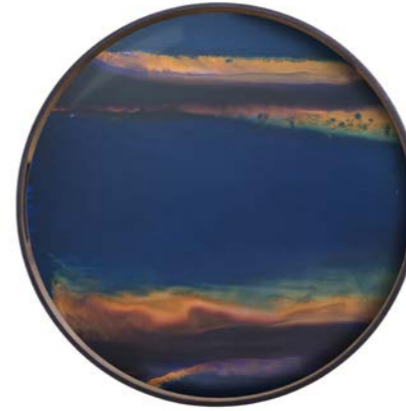

ORGANIC TRAY ●

hand painted glass with a wooden rim

indigo - small round

20360 48 × 48 × 4 cm
19" × 19" × 1.5"



ORGANIC TRAY ●

hand painted glass with a wooden rim

blue mist - small round

20371 48 × 48 × 4 cm
19" × 19" × 1.5"





ORGANIC TRAY ●

hand painted glass with a wooden rim

slate - small round

20911 48 × 48 × 4 cm
19" × 19" × 1.5"



ORGANIC TRAY ●

hand painted glass with a wooden rim

black - small round

20583 48 × 48 × 4 cm
19" × 19" × 1.5"

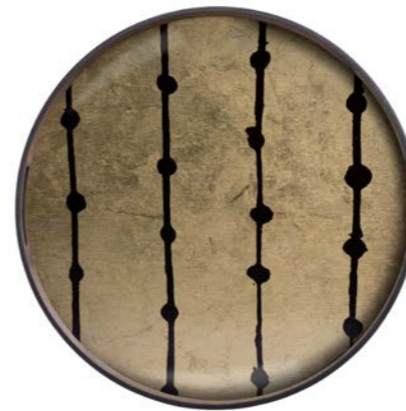
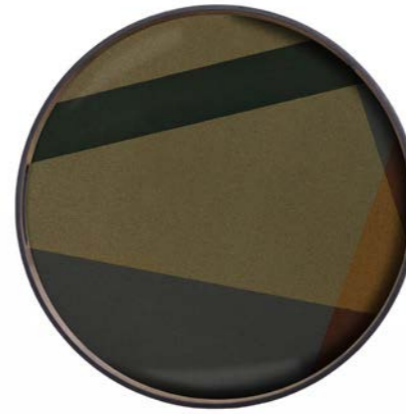

ANGLE TRAY ●

hand painted base with silk-screen printed glass and a wooden rim

slate - small round

20572 48 × 48 × 4 cm
19" × 19" × 1.5"



WABI SABI TRAY ●

hand painted base with silk-screen printed glass and a wooden rim

sand - small round

20459 48 × 48 × 4 cm
19" × 19" × 1.5"



GOLD LEAF DOTS TRAY ●

silk-screen printed glass with gold leaf and a wooden rim

small round

20418 48 × 48 × 4 cm
19" × 19" × 1.5"





CONNECTED DOTS TRAY ●

hand painted base with silk-screen printed glass and a wooden rim

small round

20438 48 × 48 × 4 cm
19" × 19" × 1.5"



LAYERED DOTS TRAY ●

hand painted base with silk-screen printed glass and a wooden rim

pinot - small round

20437 48 × 48 × 4 cm
19" × 19" × 1.5"



LINEAR SQUARES TRAY ●

silk-screen printed glass with a wooden rim

midnight - small round

20910 48 × 48 × 4 cm
19" × 19" × 1.5"



MARRAKESH TRAY ●

hand painted and silk-screen printed wood (V)

white - large round

20336 61 × 61 × 4 cm
24" × 24" × 1.5"



MARRAKESH TRAY ●

hand painted and silk-screen printed wood (V)

black - large round

20436 61 × 61 × 4 cm
24" × 24" × 1.5"



TREE TRAY ●

hand painted and silk-screen printed wood (V)

white - large round

20303 61 × 61 × 4 cm
24" × 24" × 1.5"





TREE TRAY ●
hand painted and silk-screen printed wood (V)

black - large round
20404 61 × 61 × 4 cm
24" × 24" × 1.5"



FOLK TRAY ●
hand painted and silk-screen printed wood (V)

large round
20936 61 × 61 × 4 cm
24" × 24" × 1.5"



BEADS TRAY ●
hand painted and silk-screen printed wood (V)

seaside - large round
20374 61 × 61 × 4 cm
24" × 24" × 1.5"



AGED TRAY ●
heavy aged mirror with a wooden rim

clear - large round
20315 61 × 61 × 4 cm
24" × 24" × 1.5"



MOROCCAN FROST TRAY ●
light aged and silk-screen printed mirror with a wooden rim

large round
20310 61 × 61 × 4 cm
24" × 24" × 1.5"



BEADS TRAY ●
light aged and silk-screen printed mirror with a wooden rim

gold - large round
20373 61 × 61 × 4 cm
24" × 24" × 1.5"





SLICE TRAY ●

silk-screen printed mirror with a wooden rim

bronze - large round
20407 61 × 61 × 4 cm
24" × 24" × 1.5"



ORGANIC TRAY ●

hand painted glass with a wooden rim

bronze - large round
20584 61 × 61 × 4 cm
24" × 24" × 1.5"



ORGANIC TRAY ●

hand painted glass with a wooden rim

graphite - large round
20913 61 × 61 × 4 cm
24" × 24" × 1.5"



ANGLE TRAY ●

hand painted base with silk-screen printed glass and a wooden rim

pinot - large round
20573 61 × 61 × 4 cm
24" × 24" × 1.5"



WABI SABI TRAY ●

hand painted base with silk-screen printed glass and a wooden rim

slate - large round
20461 61 × 61 × 4 cm
24" × 24" × 1.5"





LAYERED DOTS TRAY ●
hand painted base with silk-screen
printed glass and a wooden rim

slate - large round
20440 61 × 61 × 4 cm
24" × 24" × 1.5"



OVERLAPPING DOTS TRAY ●
hand painted base with silk-screen
printed glass and a wooden rim

large round
20439 61 × 61 × 4 cm
24" × 24" × 1.5"



LINEAR SQUARES TRAY ●
silk-screen printed glass with a wooden rim

ink - large round
20912 61 × 61 × 4 cm
24" × 24" × 1.5"



SLICE TRAY ●
hand painted and silk-screen printed wood (V)

white - xl round
20378 92 × 92 × 4 cm
36" × 36" × 1.5"



SLICE TRAY ●
hand painted and silk-screen printed wood (V)

black - xl round
20379 92 × 92 × 4 cm
36" × 36" × 1.5"





BEADS TRAY ●
hand painted and silk-screen printed wood (V)

midnight - xl round
20449 92 × 92 × 4 cm
36" × 36" × 1.5"

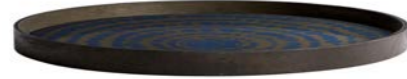

ASYMMETRIC DOT TRAY ●
hand painted and silk-screen printed wood (V)

xl round
20937 92 × 92 × 4 cm
36" × 36" × 1.5"



AGED TRAY ●
heavy aged mirror with a wooden rim

bronze - xl round
20331 92 × 92 × 4 cm
36" × 36" × 1.5"



ANGLE TRAY ●
hand painted base with silk-screen printed glass and a wooden rim

bronze - xl round
20574 92 × 92 × 4 cm
36" × 36" × 1.5"



WABI SABI TRAY ●
hand painted base with silk-screen printed glass and a wooden rim

graphite - xl round
20462 92 × 92 × 4 cm
36" × 36" × 1.5"





COMBINED DOTS TRAY ●

hand painted base with silk-screen
printed glass and a wooden rim

graphite - xl round

20909 92 × 92 × 4 cm
36" × 36" × 1.5"



COMBINED DOTS TRAY ●

hand painted base with silk-screen
printed glass and a wooden rim

pinot - xl round

20908 92 × 92 × 4 cm
36" × 36" × 1.5"



LINEAR SQUARES TRAY ●

silk-screen printed glass with a wooden rim

slate - xl round

20914 92 × 92 × 4 cm
36" × 36" × 1.5"



**Unexpected pops of saturated hues, surprising and
luxurious details. Be bold and dare to mix and match,
to create a truly individual style.**



TREE TRAY ●

Hand painted and silk-screen printed wood (V)

white - medium oblong
20566 71 × 36 × 3 cm
28" × 14" × 1"



TREE TRAY ●

hand painted and silk-screen printed wood (V)

black - medium oblong
20563 71 × 36 × 3 cm
28" × 14" × 1"



AGED TRAY ●

heavy aged mirror with a wooden rim

bronze - medium oblong
20560 71 × 36 × 3 cm
28" × 14" × 1"



ORGANIC TRAY ●

hand painted glass with a walnut wooden rim

bronze - medium oblong
20369 71 × 36 × 3 cm
28" × 14" × 1"



ORGANIC TRAY ●

hand painted glass with a wooden rim

graphite - medium oblong
20917 71 × 36 × 3 cm
28" × 14" × 1"



ORGANIC TRAY ●

hand painted glass with a wooden rim

black - medium oblong
20467 71 × 36 × 3 cm
28" × 14" × 1"





LINEAR SQUARES TRAY ●

silk-screen printed glass with a wooden rim

slate - medium oblong

20916 71 × 36 × 3 cm

28" × 14" × 1"



WABI SABI TRAY ●

hand painted base with silk-screen printed glass and a wooden rim

graphite - medium oblong

20580 71 × 36 × 3 cm

28" × 14" × 1"



ANGLE TRAY ●

hand painted base with silk-screen printed glass and a wooden rim

pinot - medium oblong

20575 71 × 36 × 3 cm

28" × 14" × 1"



CONNECTED DOTS TRAY ●

hand painted base with silk-screen printed glass and a wooden rim

medium oblong

20543 71 × 36 × 3 cm

28" × 14" × 1"





AGED TRAY ●

heavy aged mirror with a wooden rim

frost - medium rectangular

20366 69 × 31 × 5 cm
27" × 12" × 2"

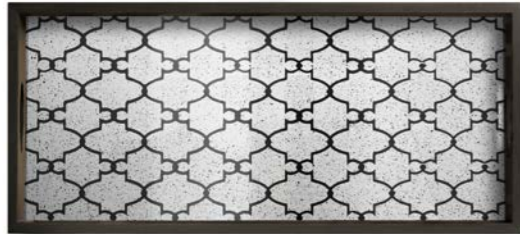

GATE TRAY ●

medium aged and silk-screen
printed mirror with a wooden rim

bronze - medium rectangular

20430 69 × 31 × 5 cm
27" × 12" × 2"



AGED TRAY ●

heavy aged mirror with a wooden rim

bronze - medium rectangular

20356 69 × 31 × 5 cm
27" × 12" × 2"



WABI SABI TRAY ●

hand painted base with silk-screen
printed glass and a wooden rim

slate - medium rectangular

20465 69 × 31 × 5 cm
27" × 12" × 2"



DOTS TRAY ●

hand painted base with silk-screen
printed glass and a wooden rim

sienna - medium rectangular

20442 69 × 31 × 5 cm
27" × 12" × 2"



LINEAR SQUARES TRAY ●

silk-screen printed glass with a
walnut wooden rim

walnut - medium rectangular

20915 69 × 31 × 5 cm
27" × 12" × 2"





SLICES TRAY ●
hand painted and silk-screen printed wood (V)

white - small square
20567 38 × 38 × 4 cm
15" × 15" × 1.5"



TREE TRAY ●
hand painted and silk-screen printed wood (V)

black - small square
20564 38 × 38 × 4 cm
15" × 15" × 1.5"



AGED TRAY ●
heavy aged mirror with a wooden rim

clear - small square
20570 38 × 38 × 4 cm
15" × 15" × 1.5"



AGED TRAY ●
heavy aged mirror with a wooden rim

bronze - small square
20561 38 × 38 × 4 cm
15" × 15" × 1.5"



ANGLE TRAY ●
hand painted base with silk-screen printed glass
and a wooden rim

slate - small square
20576 38 × 38 × 4 cm
15" × 15" × 1.5"

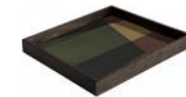

WABI SABI TRAY ●
hand painted base with silk-screen
printed glass and a wooden rim

blue - small square
20581 38 × 38 × 4 cm
15" × 15" × 1.5"





OVERLAPPING DOTS TRAY ●

hand painted base with silk-screen
printed glass and a wooden rim

cinnamon - small square
20544 38 × 38 × 4 cm
15" × 15" × 1.5"



SQUARES TRAY ●

silk-screen printed glass with a walnut wooden rim

pumpkin - small square
20918 38 × 38 × 4 cm
15" × 15" × 1.5"

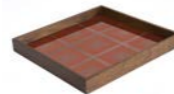

SQUARES TRAY ●

silk-screen printed glass with a walnut wooden rim

ink - small square
20919 38 × 38 × 4 cm
15" × 15" × 1.5"

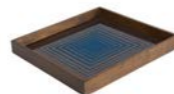

TREE TRAY ●

hand painted and silk-screen printed wood (V)

white - large square
20568 51 × 51 × 4 cm
20" × 20" × 1.5"



SLICES TRAY ●

hand painted and silk-screen printed wood (V)

black - large square
20565 51 × 51 × 4 cm
20" × 20" × 1.5"



AGED TRAY ●

heavy aged mirror with a wooden rim

clear - large square
20571 51 × 51 × 4 cm
20" × 20" × 1.5"





AGED TRAY ●

heavy aged mirror with a wooden rim

bronze - large square

20562 51 × 51 × 4 cm
20" × 20" × 1.5"



ANGLE TRAY ●

hand painted base with silk-screen printed glass
and a wooden rim

slate - large square

20577 51 × 51 × 4 cm
20" × 20" × 1.5"

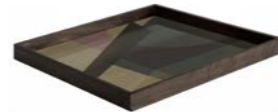

WABI SABI TRAY ●

hand painted base with silk-screen printed glass
and a wooden rim

cream - large square

20582 51 × 51 × 4 cm
20" × 20" × 1.5"



LAYERED DOTS TRAY ●

hand painted base with silk-screen printed glass
and a wooden rim

cinnamon - large square

20545 51 × 51 × 4 cm
20" × 20" × 1.5"



SQUARES TRAY ●

silk-screen printed glass with a walnut wooden rim

pumpkin - large square

20921 51 × 51 × 4 cm
20" × 20" × 1.5"

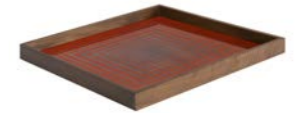

SQUARES TRAY ●

silk-screen printed glass with a walnut wooden rim

ink - large square

20920 51 × 51 × 4 cm
20" × 20" × 1.5"

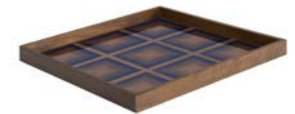

VALET TRAYS



GEO STUDY VALET TRAY ●
hand painted and silk-screen printed wood 

20930 23 × 23 × 3 cm
9" × 9" × 1"



ORGANIC VALET TRAY ●
hand painted glass with a walnut wooden rim

bronze
20468 30 × 30 × 3 cm
12" × 12" × 1"



ORGANIC VALET TRAY ●
hand painted glass with a wooden rim

slate
20923 30 × 30 × 3 cm
12" × 12" × 1"



ORGANIC VALET TRAY ●
hand painted glass with a wooden rim

graphite
20924 30 × 30 × 3 cm
12" × 12" × 1"



CHEVRON VALET TRAY ●
silk-screen printed glass with gold leaf and a gold metal rim

set of 2 halfmoons
20542 15 × 30 × 3 cm
6" × 12" × 1"



GEOMETRIC VALET TRAY ●
silk-screen printed glass with gold leaf and a gold metal rim

set of 2 halfmoons
20541 15 × 30 × 3 cm
6" × 12" × 1"

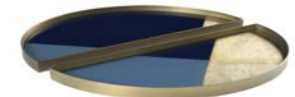



ORGANIC VALET TRAY ●
hand painted glass with a walnut wooden rim

bronze
20469 42 × 24 × 3 cm
16.5" × 9.5" × 1"



ORGANIC VALET TRAY ●
hand painted glass with a wooden rim

black
20466 42 × 24 × 3 cm
16.5" × 9.5" × 1"



DESK ORGANISER SET ●
silk-screen printed glass
with a walnut wooden holder

20398 33 × 33 × 4 cm
13" × 13" × 1.5"



ORGANIC VALET TRAY ●
hand painted glass with a bronze metal rim

fossil - 3 sizes available
20383 16 × 16 × 3 cm
6.5" × 6.5" × 1"
20384 31 × 17 × 3 cm
12" × 6.5" × 1"
20385 46 × 18 × 3 cm
18" × 7" × 1"



GOLD LEAF VALET TRAY ●
clear glass with gold leaf and a gold metal rim

3 sizes available
20386 16 × 16 × 3 cm
6.5" × 6.5" × 1"
20387 31 × 17 × 3 cm
12" × 6.5" × 1"
20388 46 × 18 × 3 cm
18" × 7" × 1"



AGED VALET TRAY ●
heavy aged mirror tray with a black metal rim

charcoal - 3 sizes available
20523 16 × 16 × 3 cm
6.5" × 6.5" × 1"
20524 31 × 17 × 3 cm
12" × 6.5" × 1"
20525 46 × 18 × 3 cm
18" × 7" × 1"

perfect combination

Create a table that is uniquely yours by choosing one of our favourite tray combinations, or by selecting your own matching pair of trays.

SMALL & LARGE TRAYS

SMALL & LARGE TRAYS



20305 slice wooden tray - white
20303 tree wooden tray - white



20360 organic glass tray - indigo
20404 tree wooden tray - black



20370 beads wooden tray - black
20436 marrakesh wooden tray - black



20335 blossom wooden tray
20336 marrakesh wooden tray - white



20402 slice mirror tray - clear
20407 slice mirror tray - bronze



20450 aged mirror tray - charcoal
20436 marrakesh wooden tray - black



20361 organic glass tray - mist gold
20373 beads mirror tray - gold



20932 chevron wooden tray - graphite
20936 folk wooden tray

SMALL & LARGE TRAYS

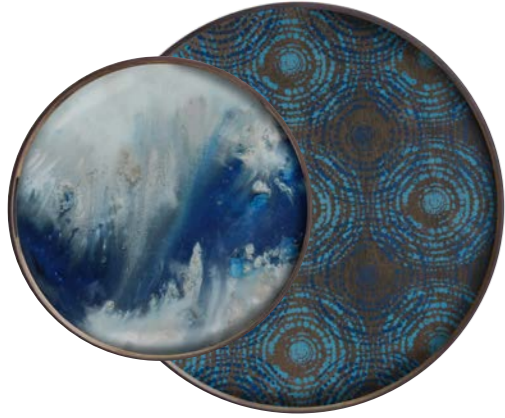

20371 organic glass tray - blue mist
20374 beads wooden tray - seaside



20583 organic glass tray - black
20373 beads mirror tray - gold

SMALL & LARGE TRAYS



20403 aged mirror tray - bronze
20584 organic glass tray - bronze



20403 aged mirror tray - bronze
20315 aged mirror tray - clear



20583 organic glass tray - black
20315 aged mirror tray - clear



20450 aged mirror tray - charcoal
20584 organic glass tray - bronze



20301 aged mirror tray - clear
20310 moroccan frost mirror tray



20572 angle glass tray - slate
20573 angle glass tray - pinot

SMALL & LARGE TRAYS



20459 wabi sabi glass tray - sand
20461 wabi sabi glass tray - slate

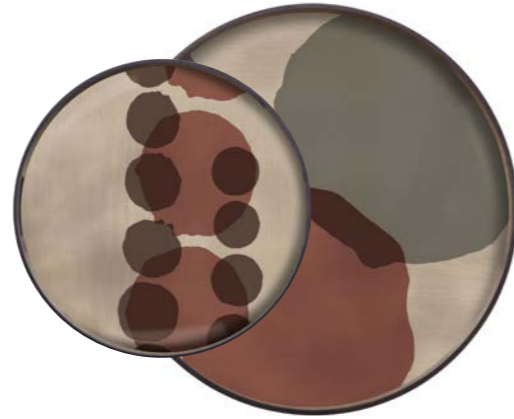

20437 layered dots glass tray - pinot
20439 overlapping dots glass tray

SMALL & LARGE TRAYS



20910 linear squares glass tray - midnight
20912 linear squares glass tray - ink



20418 gold leaf dots glass tray
20407 slice mirror tray - bronze



20438 connected dots glass tray
20440 layered dots glass tray - slate



20911 organic glass tray - slate
20913 organic glass tray - graphite

LARGE & XL TRAYS



20303 tree wooden tray - white
20378 slice wooden tray - white



20404 tree wooden tray - black
20379 slice wooden tray - black

LARGE & XL TRAYS



20936 folk wooden tray
20937 asymmetric dot wooden tray



20374 beads wooden tray - seaside
20449 beads wooden tray - midnight



20315 aged mirror tray - clear
20331 aged mirror tray - bronze



20584 organic glass tray - bronze
20331 aged mirror tray - bronze



20461 wabi sabi glass tray - slate
20462 wabi sabi glass tray - graphite



20573 angle glass tray - pinot
20574 angle glass tray - bronze

LARGE & XL TRAYS

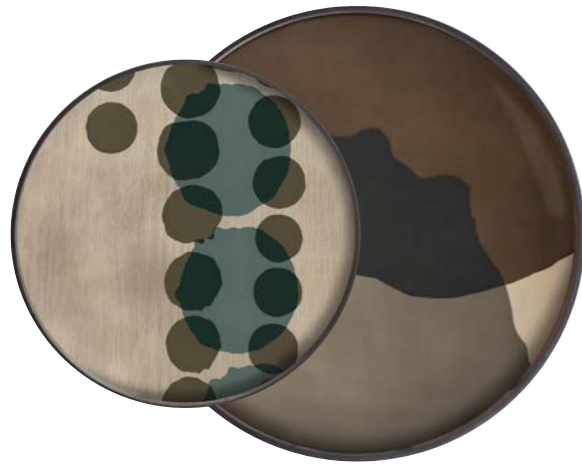

20440 layered dots glass tray - slate
20909 combined dots glass tray - graphite



20912 linear squares glass tray - ink
20914 linear squares glass tray - slate



20439 overlapping dots glass tray
20908 combined dots glass tray - pinot



20913 organic glass tray - graphite
20914 linear squares glass tray - slate

SQUARE TRAYS



20567 slices wooden tray - white
20568 tree wooden tray - white



20570 aged mirror tray - clear
20562 aged mirror tray - bronze



20564 tree wooden tray - black
20565 slices wooden tray - black



20576 angle glass tray - slate
20577 angle glass tray - slate

SQUARE TRAYS



20581 wabi sabi glass tray - blue
20582 wabi sabi glass tray - cream



20918 squares glass tray - pumpkin
20921 squares glass tray - pumpkin



20544 overlapping dots glass tray - cinnamon
20545 layered dots glass tray - cinnamon

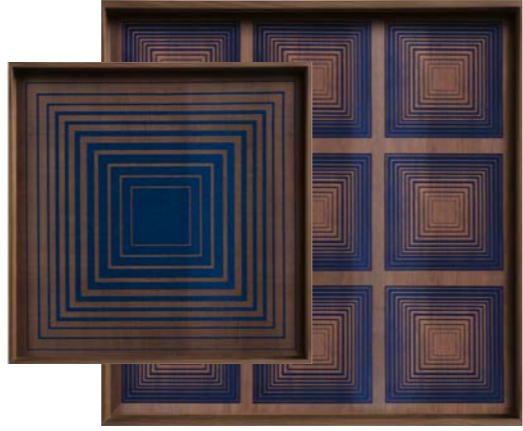

20919 squares glass tray - ink
20920 squares glass tray - ink

Vibrant colours, unique patterns and interesting shapes can elevate items from mere practicality to decorative and stylish accent pieces.

HOW IT WORKS

Adaptability, versatility, and personalisation have never been easier. Adding and removing trays is simple with our specially designed tray table bases. With secure base plates no fixing is required. Trays fit securely in place.

ROUND TRAY TABLES AND SETS

small tray

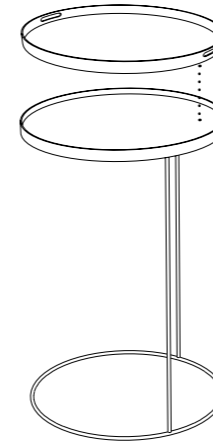

20704 49 × 49 × 66 cm
19.5" × 19.5" × 26"

small tray

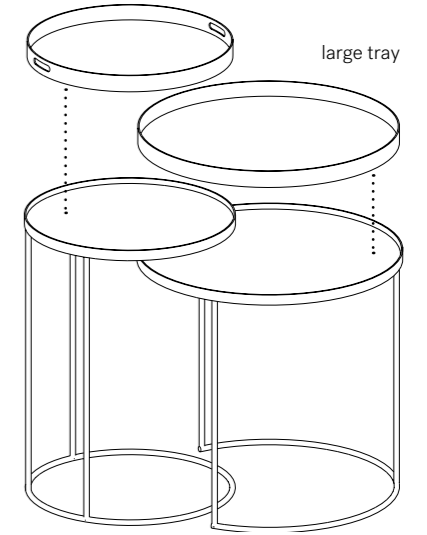

set of 2
20721 49 × 49 × 66 cm - 19.5" × 19.5" × 26"
62 × 62 × 57 cm - 24.5" × 24.5" × 22.5"

small tray

large tray

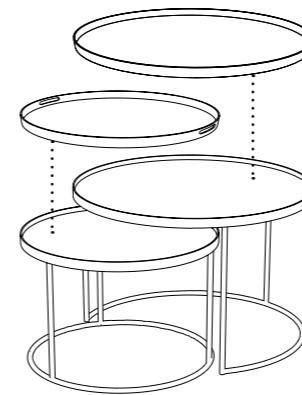

set of 2
20726 49 × 49 × 31 cm - 19.5" × 19.5" × 12"
62 × 62 × 38 cm - 24.5" × 24.5" × 15"

large tray

xl tray

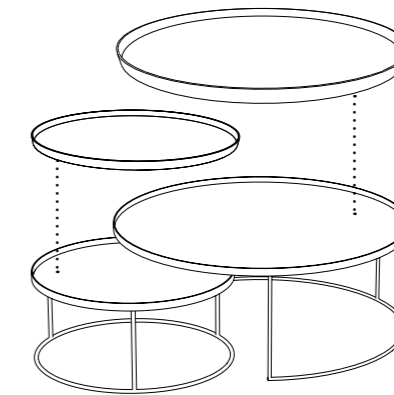

set of 2
20329 62 × 62 × 31 cm - 24.5" × 24.5" × 12"
93 × 93 × 38 cm - 36.5" × 36.5" × 15"

xl tray

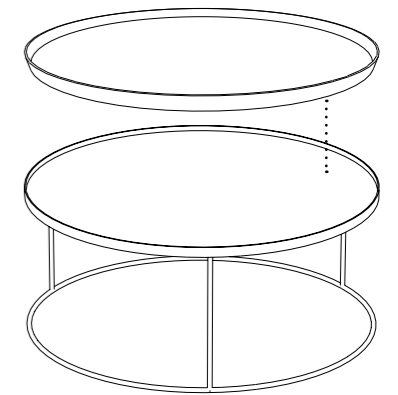

20328 93 × 93 × 38 cm
36.5" × 36.5" × 15"

RECTANGULAR AND SQUARE TRAY TABLES AND SETS

small tray

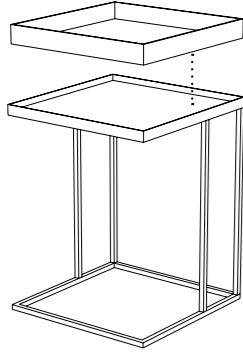

20792 39 × 39 × 50 cm
15.5" × 15.5" × 19.5"

medium tray

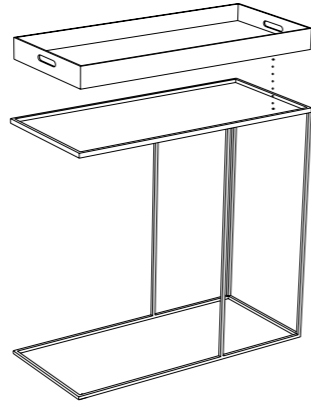

20706 70 × 32 × 64 cm
27.5" × 12.5" × 25"

large tray

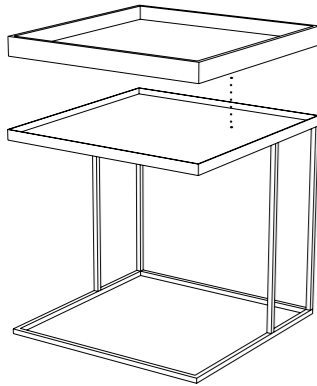

20793 52 × 52 × 50 cm
20.5" × 20.5" × 19.5"

small tray

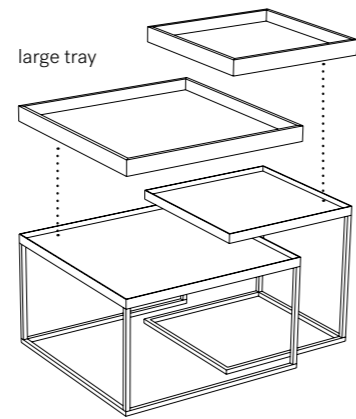

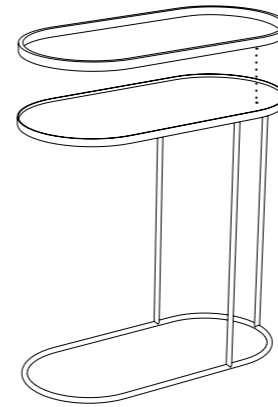

set of 2
20791 39 × 39 × 38 cm - 15.5" × 15.5" × 15"
52 × 52 × 31 cm - 20.5" × 20.5" × 12"

OBLONG TRAY SIDE TABLE



20790 69 × 33 × 65 cm
27" × 13" × 25.5"



round trays

	small tray	48 × 48 × 4 cm 19" × 19" × 1.5"
	large tray	61 × 61 × 4 cm 24" × 24" × 1.5"
	xl tray	92 × 92 × 4 cm 36" × 36" × 1.5"

rectangular trays

	medium tray	69 × 31 × 5 cm 27" × 12" × 2"
---	-------------	----------------------------------

square trays

	small tray	38 × 38 × 4 cm 15" × 15" × 1.5"
	large tray	51 × 51 × 4 cm 20" × 20" × 1.5"

oblong tray

	medium tray	71 × 36 × 3 cm 28" × 14" × 1"
---	-------------	----------------------------------

tray tables



TRAY COFFEE TABLES

* trays to be ordered separately

TRAY COFFEE TABLE SET

black tainted wood with a black metal frame

square

20791 39 × 39 × 38 cm - 15.5" × 15.5" × 15"

52 × 52 × 31 cm - 20.5" × 20.5" × 12"



TRAY COFFEE TABLE SET

black tainted wood with a black metal frame

round

20726 49 × 49 × 31 cm - 19.5" × 19.5" × 12"

62 × 62 × 38 cm - 24.5" × 24.5" × 15"



TRAY COFFEE TABLE

black tainted wood with a black metal frame

round

20328 93 × 93 × 38 cm

36.5" × 36.5" × 15"



TRAY COFFEE TABLE SET

black tainted wood with a black metal frame

round

20329 62 × 62 × 31 cm - 24.5" × 24.5" × 12"

93 × 93 × 38 cm - 36.5" × 36.5" × 15"



TRAY SIDE TABLES

* trays to be ordered separately

TRAY SIDE TABLE

black tained wood with a black metal frame

rectangular

20706 70 × 32 × 64 cm
27.5" × 12.5" × 25"



TRAY SIDE TABLE

black tained wood with a black metal frame

square

20792 39 × 39 × 50 cm
15.5" × 15.5" × 19.5"
20793 52 × 52 × 50 cm
20.5" × 20.5" × 19.5"

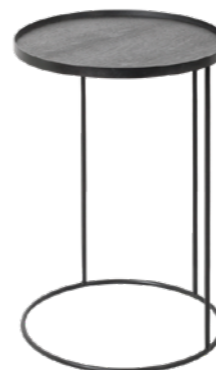

TRAY SIDE TABLE

black tained wood with a black metal frame

oblong

20790 69 × 33 × 65 cm
27" × 13" × 25.5"

TRAY SIDE TABLE

black tained wood with a black metal frame

round

20704 49 × 49 × 66 cm
19.5" × 19.5" × 26"

TRAY SIDE TABLE SET

black tained wood with a black metal frame

round

20721 49 × 49 × 66 cm - 19.5" × 19.5" × 26"
62 × 62 × 57 cm - 24.5" × 24.5" × 22.5"

side tables



GEOMETRIC SIDE TABLE

solid oak

(also available in:)

50537 51 × 51 × 50 cm
20" × 20" × 19.5"



TWIST SIDE TABLE

solid oak

50556 41 × 41 × 41 cm
16" × 16" × 16"
50557 46 × 46 × 46 cm
18" × 18" × 18"
50558 51 × 51 × 51 cm
20" × 20" × 20"



MIKADO SIDE TABLE

solid oak

50541 50 × 50 × 50 cm
19.5" × 19.5" × 19.5"



BOK SIDE TABLE

solid oak

(also available in:)

51501 43 × 43 × 50 cm
17" × 17" × 19.5"



TRIPOD SIDE TABLE

solid oak

also available in:

50508 46 × 46 × 56 cm
18" × 18" × 22"



MONOLIT SIDE TABLE



solid oak with a black metal frame
and a removable table top

26865 48 × 48 × 51 cm
19" × 19" × 20"







PI SIDE TABLE

solid mahogany 
also available in: 

35010 47 × 47 × 50 cm
18.5" × 18.5" × 19.5"





TRIPOD SIDE TABLE

solid teak  FSC®
also available in:  

14212 46 × 46 × 56 cm
18" × 18" × 22"



GEOMETRIC SIDE TABLE



solid brown tained teak FSC® 
also available in:  

10196 51 × 51 × 50 cm
20" × 20" × 19.5"



NEW

OBLIC SIDE TABLE

solid brown tained teak FSC® 
also available in: 

10186 52 × 52 × 49 cm
20.5" × 20.5" × 19.5"



ROLLER MAX SIDE TABLE

solid dark brown tained mahogany
with a removable table top 

square

35004 50 × 50 × 42 cm
19.5" × 19.5" × 16.5"

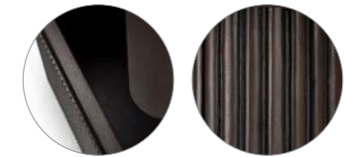

ROLLER MAX SIDE TABLE

solid dark brown tained mahogany
with a removable table top 

round

35003 40 × 40 × 42 cm
15.5" × 15.5" × 16.5"





PI SIDE TABLE

solid dark brown tained mahogany [Ⓟ]
also available in: ●

35005 47 × 47 × 50 cm
18.5" × 18.5" × 19.5"



GEOMETRIC SIDE TABLE

solid black tained oak [Ⓟ] [Ⓟ]
also available in: ● ●

50536 51 × 51 × 50 cm
20" × 20" × 19.5"



OBLIC SIDE TABLE

solid black tained teak FSC[®] [Ⓟ]
also available in: ●

10185 52 × 52 × 49 cm
20.5" × 20.5" × 19.5"



FIN SIDE TABLE

solid black tained teak FSC[®] [Ⓟ] [Ⓟ]

10193 50 × 50 × 50 cm
19.5" × 19.5" × 19.5"





ABSTRACT SIDE TABLE

solid black tained teak FSC[®] [Ⓟ] [Ⓟ]

10120 56 × 52 × 49 cm
22" × 20.5" × 19.5"





BOK SIDE TABLE
solid black tainted oak  
also available in: 

51510 43 × 43 × 50 cm
17" × 17" × 19.5"



STONE SIDE TABLE
marble top with a black metal frame

white carrara
60090 60 × 53 × 45 cm
23.5" × 21" × 17.5"

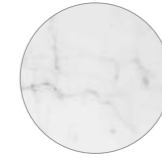

TRIPOD SIDE TABLE
solid black tainted oak  
also available in:  

50527 46 × 46 × 56 cm
18" × 18" × 22"



STONE SIDE TABLE
marble top with a black metal frame

dark emperador
60091 60 × 53 × 45 cm
23.5" × 21" × 17.5"

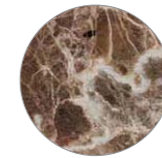



NESTING SIDE TABLE

heavy aged mirror table top with
a black metal frame

set of 2 - clear

20723 43 × 43 × 56 cm - 17" × 17" × 22"
56 × 56 × 69 cm - 22" × 22" × 27"

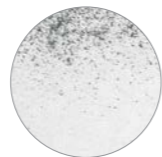

NESTING SIDE TABLE

heavy aged mirror table top with
a black metal frame

set of 2 - bronze copper

20702 43 × 43 × 56 cm - 17" × 17" × 22"
56 × 56 × 69 cm - 22" × 22" × 27"



NESTING SIDE TABLE

heavy aged mirror table top with
a black metal frame

set of 2 - charcoal

20703 43 × 43 × 56 cm - 17" × 17" × 22"
56 × 56 × 69 cm - 22" × 22" × 27"

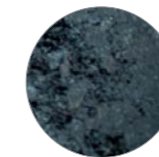

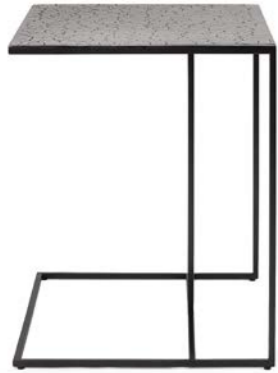

TRIPTIC SIDE TABLE

made from mineral powders, water, earth,
natural colour pigments and metallic powders.
(also available in: ●●)

lava taupe
25911 45 × 40 × 51 cm
17.5" × 15.5" × 20"

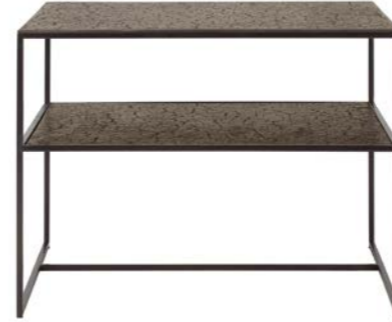
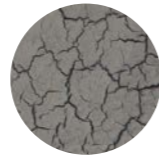

PENTAGON SIDE TABLE

made from mineral powders, water, earth,
natural colour pigments and metallic powders.

lava whisky
25894 60 × 53 × 45 cm
23.5" × 21" × 17.5"



CELESTE SIDE TABLE

made from mineral powders, water, earth,
natural colour pigments and metallic powders.
(also available in: ●●)

lava taupe
25923 45 × 45 × 43 cm
17.5" × 17.5" × 17"

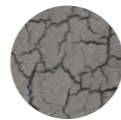

CELESTE SIDE TABLE

made from mineral powders, water, earth,
natural colour pigments and metallic powders.
(also available in: ●●)

lava linear taupe
25922 45 × 45 × 50 cm
17.5" × 17.5" × 19.5"

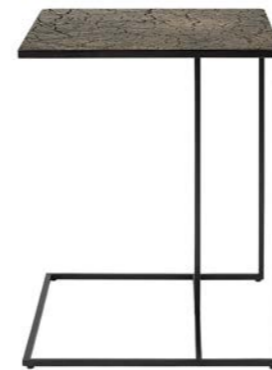
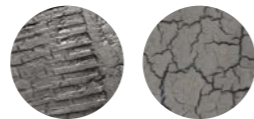

TRIPTIC SIDE TABLE

made from mineral powders, water, earth,
natural colour pigments and metallic powders.
(also available in: ●●)

lava whisky
25913 45 × 40 × 51 cm
17.5" × 15.5" × 20"





CELESTE SIDE TABLE

made from mineral powders, water, earth,
natural colour pigments and metallic powders.
(also available in: ● ●)

lava whisky

25925 45 × 45 × 43 cm
17.5" × 17.5" × 17"



CELESTE SIDE TABLE

made from mineral powders, water, earth,
natural colour pigments and metallic powders.
(also available in: ● ●)

lava linear whisky

25924 45 × 45 × 50 cm
17.5" × 17.5" × 19.5"



ELLIPSE SIDE TABLE

made from mineral powders, water, earth,
natural colour pigments and metallic powders.

umber

25912 45 × 40 × 51 cm
17.5" × 15.5" × 20"

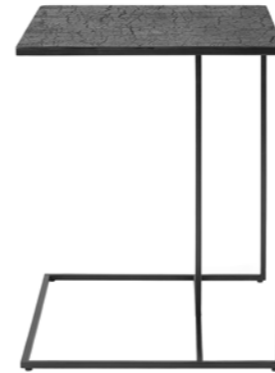

TRIPTIC SIDE TABLE

made from mineral powders, water, earth,
natural colour pigments and metallic powders.
(also available in: ● ●)

lava black

25914 45 × 40 × 51 cm
17.5" × 15.5" × 20"

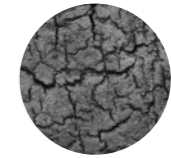

CELESTE SIDE TABLE

made from mineral powders, water, earth,
natural colour pigments and metallic powders.
(also available in: ● ●)

lava black

25927 45 × 45 × 43 cm
17.5" × 17.5" × 17"

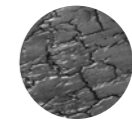

CELESTE SIDE TABLE

made from mineral powders, water, earth,
natural colour pigments and metallic powders.
(also available in: ● ●)

lava linear black

25926 45 × 45 × 50 cm
17.5" × 17.5" × 19.5"

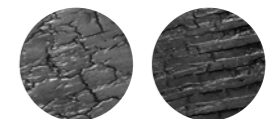

wall decor



LIGHT FRAME FLOOR MIRROR

solid wooden frame

clear - oak ☉

51299 90 × 5 × 200 cm
35.5" × 2" × 78.5"

clear - black tainted oak ☽

51289 90 × 5 × 200 cm
35.5" × 2" × 78.5"



GATE FLOOR MIRROR

metal frame

clear medium aged

20607 80 × 3 × 200 cm
31.5" × 1" × 78.5"

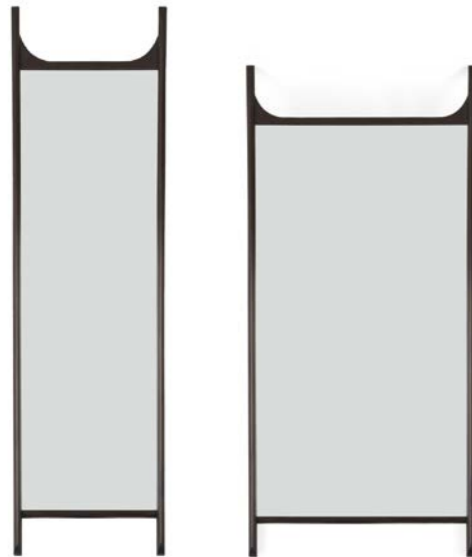
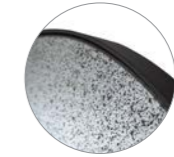

NEW

PI FLOOR MIRROR

solid dark brown tainted

mahogany frame ☽

29781 55 × 5 × 190 cm
21.5" × 2" × 75"

29784 80 × 5 × 200 cm
31.5" × 2" × 78.5"



AGED FLOOR MIRROR
metal frame

clear medium aged

20663 71 × 3 × 244 cm

28" × 1" × 96"

20674 80 × 3 × 200 cm

31.5" × 1" × 78.5"

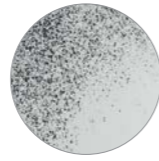

AGED FLOOR MIRROR
metal frame

bronze heavy aged

20661 71 × 3 × 244 cm

28" × 1" × 96"

20675 80 × 3 × 200 cm

31.5" × 1" × 78.5"

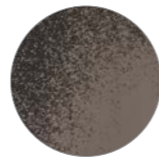

PI WALL MIRROR
solid dark brown tinted
mahogany frame

clear

29776 100 × 3 × 100 cm

39.5" × 1" × 39.5"



NEW
CAMBER WALL MIRROR
walnut frame

bronze

20680 60 × 3 × 60 cm

23.5" × 1" × 23.5"



EDGE WALL MIRROR
mahogany frame

clear medium aged

20609 61 × 5 × 91 cm

24" × 2" × 36"

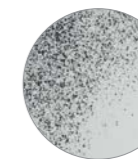

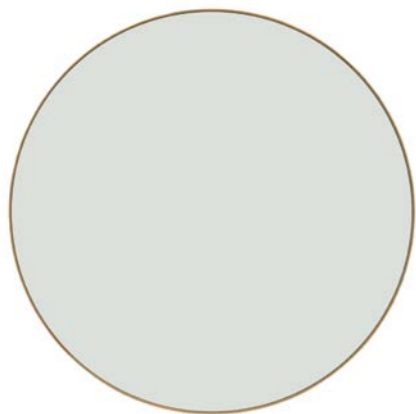

LAYERS WALL MIRROR

oak veneer frame 

round - clear

58164 91 x 4 x 91 cm

36" x 1.5" x 36"

58165 121 x 4 x 121 cm

47.5" x 1.5" x 47.5"



AGED WALL MIRROR

wooden frame

round - clear medium aged

20600 48 x 3 x 48 cm

19" x 1" x 19"

20601 61 x 3 x 61 cm

24" x 1" x 24"

20604 92 x 3 x 92 cm

36" x 1" x 36"

20611 121 x 3 x 121 cm

47.5" x 1" x 47.5"



AGED WALL MIRROR

wooden frame

round - bronze heavy aged

20602 48 x 3 x 48 cm

19" x 1" x 19"

20603 61 x 3 x 61 cm

24" x 1" x 24"

20605 92 x 3 x 92 cm

36" x 1" x 36"

20613 121 x 3 x 121 cm

47.5" x 1" x 47.5"



SPHERE WALL MIRROR

wall mirror with a frame made from mineral powders, water, earth, natural colour pigments and metallic powders.

clear - umber

25955 78 x 3 x 78 cm

30.5" x 1" x 30.5"

25956 99 x 3 x 99 cm

39" x 1" x 39"



GATE WALL MIRROR

metal frame

clear medium aged

20608 60 x 3 x 92 cm

23.5" x 1" x 36"

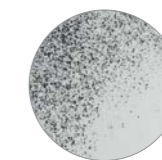



AGED WALL MIRROR
wall mirror with a metal frame

clear medium aged

20676 76 × 3 × 106 cm
30" × 1" × 41.5"

20662 122 × 3 × 153 cm
48" × 1" × 60"

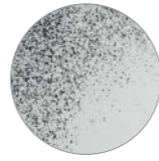

AGED WALL MIRROR
metal frame



bronze heavy aged

20677 76 × 3 × 106 cm
30" × 1" × 41.5"

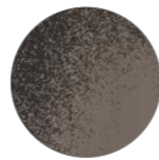
20660 122 × 3 × 153 cm
48" × 1" × 60"



WALL SHELF

oak veneer 
(also available in: )

51358 70 × 22 × 5 cm
27.5" × 8.5" × 2"

51359 140 × 22 × 5 cm
55" × 8.5" × 2"

51360 210 × 22 × 5 cm
82.5" × 8.5" × 2"



RIBBON SHELF

solid oak with a white metal frame 

26616 70 × 20 × 17 cm
27.5" × 8" × 6.5"

26615 140 × 20 × 17 cm
55" × 8" × 6.5"



U SHELF

solid oak with a white metal frame 

26194 55 × 20 × 20 cm
21.5" × 8" × 8"

26204 70 × 15 × 15 cm
27.5" × 6" × 6"





RIBBON SHELF

solid oak with a black metal frame ☺
(also available in: ●)

26623 70 × 20 × 17 cm
27.5" × 8" × 6.5"

26617 140 × 20 × 17 cm
55" × 8" × 6.5"



U SHELF

solid oak with a black metal frame ☺

26202 55 × 20 × 20 cm
21.5" × 8" × 8"

26211 70 × 15 × 15 cm
27.5" × 6" × 6"



PI WALL SHELF

solid mahogany ☺

2 shelves

29777 100 × 35 × 91 cm
39.5" × 14" × 36"



PI WALL SHELF

solid mahogany ☺

3 shelves

29778 100 × 35 × 126 cm
39.5" × 14" × 49.5"



PI WALL SHELF
solid mahogany [Ⓟ]

5 shelves
29779 100 × 35 × 196 cm
39.5" × 14" × 77"



WALL SHELF

black tainted oak veneer [Ⓟ]
(also available in: ●)

51268 70 × 22 × 5 cm
27.5" × 8.5" × 2"
51269 140 × 22 × 5 cm
55" × 8.5" × 2"
51270 210 × 22 × 5 cm
82.5" × 8.5" × 2"



RIBBON SHELF

solid black tainted oak
with a black metal frame [Ⓟ]
(also available in: ●)

26624 70 × 20 × 17 cm
27.5" × 8" × 6.5"
26618 140 × 20 × 17 cm
55" × 8" × 6.5"



PI WALL HANGER
solid sycamore (V)
(also available in: ● ●)

set of 2
29865 3 × 8 × 21 cm
1" × 3" × 8.5"



PI WALL HANGER
solid mahogany (V)
(also available in: ● ●)

set of 2
29765 3 × 8 × 21 cm
1" × 3" × 8.5"



PI WALL HANGER
solid dark brown tainted mahogany (V)
(also available in: ● ●)

set of 2
29775 3 × 8 × 21 cm
1" × 3" × 8.5"



NEW
PI WALL COAT RACK
solid dark brown tainted mahogany (V)

29782 70 × 10 × 21 cm
27.5" × 4" × 8.5"



UTILITILE WALL HANGER
solid oak (V)
(also available in: ●)

55097 40 × 4 × 40 cm
15.5" × 1.5" × 15.5"



UTILITILE WALL HANGER
solid black tainted oak (V)
(also available in: ●)

55101 40 × 4 × 40 cm
15.5" × 1.5" × 15.5"



NEW

BRICKS WALL ART

handmade from a selection of dark brown tained solid woods (V)

- 29991 60 × 4 × 50 cm
23.5" × 1.5" × 19.5"
- 29993 90 × 4 × 60 cm
35.5" × 1.5" × 23.5"
- 29995 100 × 4 × 100 cm
39.5" × 1.5" × 39.5"
- 29997 120 × 4 × 90 cm
47" × 1.5" × 35.5"



NEW

BRICKS WALL ART

handmade from a selection of black tained solid woods (V)

- 29990 60 × 4 × 50 cm
23.5" × 1.5" × 19.5"
- 29992 90 × 4 × 60 cm
35.5" × 1.5" × 23.5"
- 29994 100 × 4 × 100 cm
39.5" × 1.5" × 39.5"
- 29996 120 × 4 × 90 cm
47" × 1.5" × 35.5"

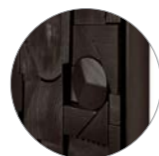

LAYERED CLAY WALL ART

made from mineral powders, water, earth, natural colour pigments and metallic powders with a metal frame

- 20643 46 × 3 × 46 cm
18" × 1" × 18"
- 20644 61 × 3 × 61 cm
24" × 1" × 24"
- 20645 84 × 3 × 84 cm
33" × 1" × 33"

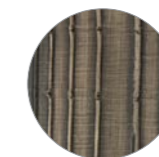

NEW

MOONLIGHT WALL LAMP

made with metal and electroplated brass with a bronze topcoat (V)

only available in EU

left curve

- 26966 28 × 8 × 39 cm
11" × 3" × 15.5"

right curve

- 26965 28 × 8 × 39 cm
11" × 3" × 15.5"

objects



STRIPED BOWL
solid black tainted mahogany (V)
29732 40 x 40 x 14 cm
15.5" x 15.5" x 5.5"



NEW
CHOPPED BOWL XL
solid black tainted mahogany (V)
29730 65 x 65 x 26 cm
25.5" x 25.5" x 10"



CHOPPED BOWLS
solid black tainted mahogany (V)
set of 3
29731 14 x 14 x 9 cm - 5.5" x 5.5" x 3.5"
21 x 21 x 9 cm - 8.5" x 8.5" x 3.5"
25 x 25 x 9 cm - 10" x 10" x 3.5"



THIN OVAL BOARDS
solid sycamore (V)
(also available in: ●●)
set of 2
29844 32 x 13 x 3 cm - 12.5" x 5" x 1"
46 x 15 x 3 cm - 18" x 6" x 1"



THIN OVAL BOARDS
solid mahogany (V)
(also available in: ●●)
set of 2
29744 32 x 13 x 3 cm - 12.5" x 5" x 1"
46 x 15 x 3 cm - 18" x 6" x 1"



THIN OVAL BOARDS
solid black tainted mahogany (V)
(also available in: ●●)
set of 2
29753 32 x 13 x 3 cm - 12.5" x 5" x 1"
46 x 15 x 3 cm - 18" x 6" x 1"



TAMPA BOARDS

solid dark brown tainted mahogany (V)

set of 3

- 29751 15 × 15 × 4 cm - 6" × 6" × 1.5"
- 22 × 22 × 4 cm - 8.5" × 8.5" × 1.5"
- 30 × 30 × 4 cm - 12" × 12" × 1.5"



JAPAN BOARD

solid black tainted mahogany (V)

- 29752 40 × 21 × 4 cm
- 15.5" × 8.5" × 1.5"

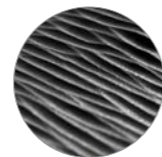

PI BOOK ENDS

solid sycamore (V)

(also available in: ● ●)

set of 2

- 29870 9 × 7 × 19 cm
- 3.5" × 3" × 7.5"



PI BOOK ENDS

solid mahogany (V)

(also available in: ● ●)

set of 2

- 29770 9 × 7 × 19 cm
- 3.5" × 3" × 7.5"



PI BOOK ENDS

solid dark brown tainted mahogany (V)

(also available in: ● ●)

set of 2

- 29780 9 × 7 × 19 cm
- 3.5" × 3" × 7.5"



NEW
PI CANDLE HOLDERS
handmade from solid,
dark brown tained mahogany

set of 3
29783

6 × 6 × 7 cm - 2.5" × 2.5" × 3"
6 × 6 × 9 cm - 2.5" × 2.5" × 3.5"
6 × 6 × 12 cm - 2.5" × 2.5" × 4.5"



GROOVES BOOK ENDS
solid dark brown tained mahogany

set of 2

29774 19 × 8 × 20 cm - 7.5" × 3" × 8"
19 × 8 × 20 cm - 7.5" × 3" × 8"



NEW
CHOPPED PAPER BASKET
solid black tained mahogany

29773 28 × 28 × 35 cm
11" × 11" × 14"



ROLLER MAX PAPER BASKET
solid black tained mahogany

29771 28 × 28 × 35 cm
11" × 11" × 14"



BERLIN OBJECT

solid espresso tainted mahogany 

29621 30 × 10 × 11 cm
12" × 4" × 4.5"



KABUL OBJECT

solid espresso tainted mahogany 

29623 16 × 7 × 12 cm
6.5" × 3" × 4.5"



TREVISO OBJECT

solid espresso tainted mahogany 

29628 15 × 12 × 9 cm
6" × 4.5" × 3.5"



BEIRUT OBJECT

solid espresso tainted mahogany 

29622 30 × 12 × 9 cm
12" × 4.5" × 3.5"



LONDON OBJECT

solid espresso tainted mahogany 

29624 28 × 8 × 12 cm
11" × 3" × 4.5"



MOSCOW OBJECT

solid espresso tainted mahogany 

29625 30 × 10 × 10 cm
12" × 4" × 4"



PISA OBJECT

solid espresso tainted mahogany

29626 10 × 10 × 20 cm
4" × 4" × 8"



BABYLON OBJECT

solid espresso tainted mahogany

29627 23 × 23 × 14 cm
9" × 9" × 5.5"



STILT HOUSE OBJECT

solid black tainted mahogany

29611 17 × 33 × 18 cm
6.5" × 13" × 7"



FARM HOUSE OBJECT

solid black tainted mahogany

29612 24 × 19 × 12 cm
9.5" × 7.5" × 4.5"



MODERN FARM HOUSE OBJECT

solid black tainted mahogany

set of 3
29613 9 × 25 × 23 cm - 3.5" × 10" × 9"
13 × 18 × 21 cm - 5" × 7" × 8.5"
17 × 18 × 21 cm - 6.5" × 7" × 8.5"





URBAN HOUSE OBJECT

solid black tainted mahogany

29631 14 × 7 × 23 cm
5.5" × 3" × 9"





ORGANIC SCULPTURE

solid sycamore 
(also available in:  )

29803 13 × 14 × 22 cm
5" × 5.5" × 8.5"



ORGANIC SCULPTURE

solid mahogany 
(also available in:  )

29703 13 × 14 × 22 cm
5" × 5.5" × 8.5"



ORGANIC SCULPTURE

solid dark brown tained mahogany 
(also available in:  )

29713 13 × 14 × 22 cm
5" × 5.5" × 8.5"



BLOCK ORGANIC SCULPTURE

solid espresso tained mahogany 

29702 17 × 14 × 36 cm
6.5" × 5.5" × 14"



BLOCK SCULPTURE

solid black tained mahogany 

29701 23 × 13 × 38 cm
9" × 5" × 15"

home textiles



NOMAD KILIM RUG
handwoven and handspun, wool

- sand
- 21700 170 × 240 cm
5'6" × 7'9"
 - 21701 200 × 300 cm
6'5" × 9'8"
 - 21702 250 × 350 cm
8'2" × 11'5"



DUNES RUG
handknotted and handspun, wool

- sand
- 21753 170 × 240 cm
5'6" × 7'9"
 - 21754 200 × 300 cm
6'5" × 9'8"
 - 21755 250 × 350 cm
8'2" × 11'5"



NOMAD KILIM RUG
handwoven and handspun, wool

- cumin
- 21724 170 × 240 cm
5'6" × 7'9"
 - 21725 200 × 300 cm
6'5" × 9'8"
 - 21726 250 × 350 cm
8'2" × 11'5"



DUNES RUG
handknotted and handspun, wool

- cumin
- 21750 170 × 240 cm
5'6" × 7'9"
 - 21751 200 × 300 cm
6'5" × 9'8"
 - 21752 250 × 350 cm
8'2" × 11'5"



NOMAD KILIM RUG
handwoven and handspun, wool

- terracotta
- 21706 170 × 240 cm
5'6" × 7'9"
 - 21707 200 × 300 cm
6'5" × 9'8"
 - 21708 250 × 350 cm
8'2" × 11'5"



CHECKED KILIM RUG
handwoven and handspun, wool

- natural
- 21727 170 × 240 cm
5'6" × 7'9"
 - 21728 200 × 300 cm
6'5" × 9'8"
 - 21729 250 × 350 cm
8'2" × 11'5"



NOMAD KILIM RUG

handwoven and handspun, wool

grey

21703 170 × 240 cm

5'6" × 7'9"

21704 200 × 300 cm

6'5" × 9'8"

21705 250 × 350 cm

8'2" × 11'5"



NOMAD KILIM RUG

handwoven and handspun, wool

dark chocolate

21721 170 × 240 cm

5'6" × 7'9"

21722 200 × 300 cm

6'5" × 9'8"

21723 250 × 350 cm

8'2" × 11'5"



DOTS KILIM RUG

handwoven with wool

black

21718 170 × 240 cm

5'6" × 7'9"

21719 200 × 300 cm

6'5" × 9'8"

21720 250 × 350 cm

8'2" × 11'5"

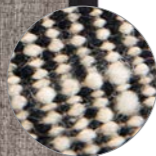

NEW

MELLOW SOFA CUSHION

42% cotton, 26% polyester, 32% polyacrylic

off white - eco fabric

20059 55 × 55 cm

21.5" × 21.5"



LIN SAUVAGE CUSHION

linen

oat

21053 60 × 60 cm

23.5" × 23.5"



LIN SAUVAGE CUSHION

linen

camel

21056 60 × 60 cm

23.5" × 23.5"





AVANA ORB CUSHION

38% polyacrylic, 33% cotton, 15% wool,
13% polyester and 1% viscose

21030 45 × 45 cm
17.5" × 17.5"



URBAN CUSHION

45% polyacrylic, 19% wool, 17% polyester,
17% cotton, 1% alpaca and 1% polyamide

21034 50 × 50 cm
19.5" × 19.5"

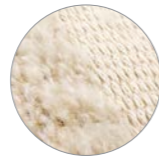

AVANA CHEVRON CUSHION

51% polyacrylic, 21% wool, 18% polyester
and 10% cotton

21036 50 × 50 cm
19.5" × 19.5"



NOMAD CUSHION

52% cotton, 32% linen, 11% viscose
and 5% polyamide

silver
21044 60 × 40 cm
23.5" × 15.5"



NOMAD CUSHION

52% cotton, 32% linen, 11% viscose
and 5% polyamide

oat
21052 60 × 40 cm
23.5" × 15.5"



NOMAD CUSHION

52% cotton, 32% linen, 11% viscose
and 5% polyamide

camel
21046 60 × 40 cm
23.5" × 15.5"





AVANA ABSTRACT CUSHION
38% polyacrylic, 33% cotton, 15% wool,
13% polyester and 1% viscose

21032 60 × 40 cm
23.5" × 15.5"



ABSTRACT DETAIL CUSHION
80% cotton, 14% polyacrylic, 3% viscose
and 3% polyester

21028 60 × 40 cm
23.5" × 15.5"

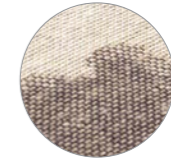

TULUM CUSHION
63% linen, 17% wool, 16% polyacrylic,
3% polyester and 1% cotton

bright
21069 60 × 40 cm
23.5" × 15.5"

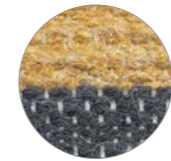

AVANA CHEVRON CUSHION
51% polyacrylic, 21% wool, 18% polyester
and 10% cotton

21038 60 × 40 cm
23.5" × 15.5"

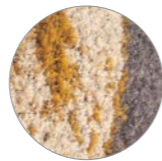

TULUM CUSHION
51% linen, 24% polyacrylic, 15% wool,
9% polyester and 1% cotton

dark
21070 60 × 40 cm
23.5" × 15.5"

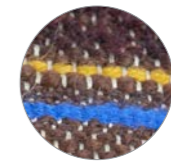



NOMAD CUSHION

52% cotton, 32% linen, 11% viscose and 5% polyamide

blue

21045 60 x 40 cm
23.5" x 15.5"



DOTS CUSHION

29% polyacrylic, 27% cotton, 22% mohair and 22% polyamide

white

21061 60 x 40 cm
23.5" x 15.5"

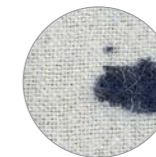

URBAN CUSHION

45% polyacrylic, 19% wool, 17% polyester, 17% cotton, 1% alpaca and 1% polyamide

21035 60 x 40 cm
23.5" x 15.5"



STRIPES CUSHION

44% polyacrylic, 23% linen, 15% cotton, 10% wool and 8% polyester

white

21063 60 x 40 cm
23.5" x 15.5"



LINEAR DIAMONDS CUSHION

29% polyacrylic, 27% cotton, 22% mohair and 22% polyamide

navy

21060 60 x 40 cm
23.5" x 13.5"

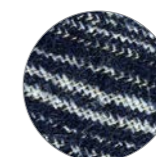



ALPONE THROW

46% polyacrylic, 20% wool,
18% cotton, 16% polyester

oat

21073 140 × 200 cm
55" × 78.5"



URBAN THROW

44% polyacrylic, 22% wool, 8% polyester,
16% cotton, 5% alpaca and 5% polyamide

21047 140 × 195 cm
55" × 77"

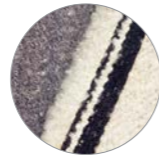

DOTS THROW

29% polyacrylic, 27% cotton, 22% mohair
and 22% polyamide

navy

21064 140 × 240 cm
55" × 94.5"

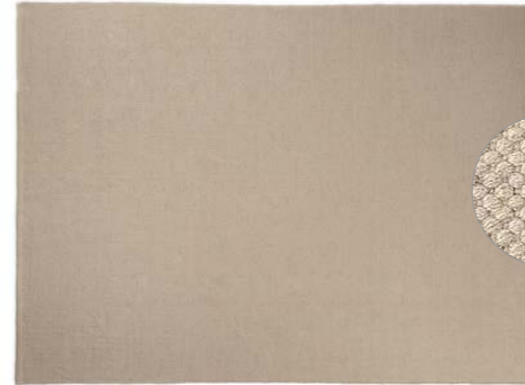

NEW

NOMAD INDOOR/OUTDOOR RUG

handwoven with recycled PET yarn

oat

21204 170 × 240 cm
5'6" × 7'9"

21205 200 × 300 cm
6'5" × 9'8"



**BOUCLE LIGHT
OUTDOOR CUSHION**

polypropylene, quick-dry foam

white

21103 50 × 50 cm
19.5" × 19.5"

21104 60 × 40 cm
23.5" × 15.5"

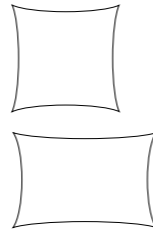

**NEW
NOMAD OUTDOOR CUSHION**

polypropylene, quick-dry foam

cumin

21153 50 × 50 cm
19.5" × 19.5"

21152 60 × 40 cm
23.5" × 15.5"

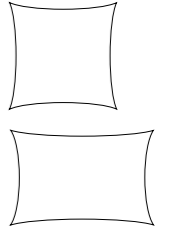

BOUCLE OUTDOOR CUSHION

polypropylene, quick-dry foam

oat

21105 50 × 50 cm
19.5" × 19.5"

21106 60 × 40 cm
23.5" × 15.5"



**NEW
NOMAD OUTDOOR CUSHION**

polypropylene, quick-dry foam

marsala

21151 50 × 50 cm
19.5" × 19.5"

21150 60 × 40 cm
23.5" × 15.5"

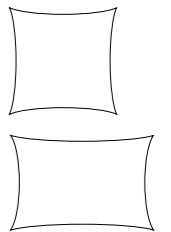



LINES OUTDOOR CUSHION

polypropylene, quick-dry foam

white

21100 50 × 50 cm
19.5" × 19.5"



DOTS OUTDOOR CUSHION

polypropylene, quick-dry foam

white

21101 55 × 35 cm
21.5" × 14"



STRIPES OUTDOOR CUSHION

polypropylene, quick-dry foam

white

21102 60 × 40 cm
23.5" × 15.5"



**Bringing a sense of elegant simplicity to any space,
creating an interplay on texture and tone.**

general information & how to take care of our products

about natural materials

The beauty of natural materials lies in its peculiarities and imperfections. That is what separates true beauty from the artificial. Variations in wood grain and colour, knots, medullary rays and other natural characteristics are inherent in solid wood. These are far from flaws, but an intricate part of its character. Natural stone can have minor pitting or surface fissures. We believe that these imperfections contribute to the charm of Ethnicraft products.

Wood, like any other natural and porous material, continues to absorb and release humidity throughout its life. Although Ethnicraft designs furniture that adapts well to the hydrometric conditions of its environment, some cracking or movement may occur. Please do not be alarmed; this is a normal response to the furniture's environment.

UNIQUENESS OF OUR PRODUCT

The Ethnicraft brand incorporates classic and traditional techniques, such as metal-leafing, hand-painting, silkscreen printing and aging. Due to the handcrafted nature of our products, each item will vary slightly. We consider this a sign of uniqueness and quality.

TIMELESS DESIGN

All of our designs are intentionally timeless. They withstand trends and associate well with different styles, and they can be passed on from one home to the next, carrying over the stories of one lifetime to another. Our collections go back to the essence of what we believe is good design: pieces full of character, made from quality materials that age beautifully.

We create collections for every room of the house, from the furniture that defines the purpose of a space to the objects that layer it with meaning. Nothing excites us more than seeing how people love and use our products in the stories of their lives.

CRAFTSMANSHIP

Outstanding craftsmanship is at the core of our brand, and behind the simplicity of our pieces lies a constant drive for innovation.

Incorporating advanced techniques to our process of creation, each new design is revised and reworked to the last detail: every curve, texture and line reflect our design values.

general tips & tricks

- Recommended humidity in the room for interior products: between 40% and 60%.
- Ideal room temperature: 21°C/70°F during the day, not below 14°C/57°F at night.
- To prevent colour differences, do not place furniture or accessories in direct sunlight, move objects placed on the furniture from time to time and open extendable tables on a regular basis.
- Avoid exposure to extreme conditions: do not place furniture or accessories near heating sources or air-conditioned spaces.
- To prevent staining, we recommend that any spills are removed immediately.
- When cleaning the surface, always work in the direction of the wood grain.
- Use place mats and/or coasters to prevent hot pots and pans, or cold glasses and bottles, from damaging items.
- Do not drag the furniture along the floor; always lift the furniture when moving.
- Always ensure water and solutions used to clean the floor do not come into contact with the furniture's base, as it might leave permanent marks.
- Indoor products are not intended for outdoor use. An outdoor product will always indicate so in its name.
- Last but not least, we always recommend carefully reading the care instructions specific to your item.

For full care and maintenance information related to Ethnicraft products and materials, please link directly through to our website:



general information & how to take care of our products

All woods, hard surfaces & materials

REGULAR CARE

For dusting, use a dry cloth. For cleaning or in case of a spill, use a damp cloth and natural soap. Wipe in the direction of the grain. Do not use soap containing detergent or other chemicals. Dry with a soft, clean cloth to prevent spotting.

It is always recommended to protect any surfaces with coasters, mousepads, or placemats. Repetitive daily use or heat can damage the finish.

Always move objects such as flowerpots, vases, etc. from time to time. Ensure any excess water or dampness is wiped dry immediately to prevent marking the surface.

Trays & tray tables

Trays are intended for decorative and everyday use. They are not to be used in a setting such as, but not limited to, restaurants where they are exposed to constant washing, repetitive handling and service of heavy items.

Always use coasters to prevent hot surfaces from leaving marks or damaging trays.

GLASS & MIRROR

Wipe the glass or mirror surface with warm water or a neutral glass cleaner and soft cloth.

BOWLS & BOARDS

Our bowls and boards are finished with a food-safe varnish. This means they will not contaminate any solid or dry foods they come in contact with.

LIGHTING

Dust regularly using a dry, soft, lint-free cloth or fine brush. Use gentle strokes and avoid vigorous rubbing.

Home textiles

CUSHIONS AND TROWS

Always refer to the care label or leaflet specific to your product as some items are not to be washed, in which case we recommend dry cleaning only.

Pilling is the result of excess fibre on the fabric or from external sources. This is not a defect but a characteristic of many textiles. To remove pilling, we recommend using an antipilling machine.

SPOT CLEANING HOME TEXTILES:

- Attend to spills immediately.
- Blot up excess moisture of the spill as soon as possible with a clean, dry, white cloth. Do not rub.
- Blot up the stain with a clean, slightly damp white cloth, working from the outer edge to the centre of the stain.
- Remove any dry or solid matter (food, etc.) by scraping excess away with a spoon. Do not rub.
- Use a hair dryer on the lowest heat setting to evenly dry the fabric and prevent moisture rings.
- Never use any chemical products on our textiles.

RUGS

All of our rugs are handwoven or handknotted on a traditional loom. As these finishes are not machine programmed, nuances in the size and colour variations are to be expected.

The naturally occurring high oil content of wool makes these rugs incredibly durable, dirt and moisture resistant.

Due to this handcrafted nature, the occasional loose end that starts to come undone is expected. If this does occur, do not pull or cut it. Instead, gently push or tie it back into the weave.

For our Indoor/Outdoor rugs, the soft and sustainable PET yarn is also incredibly durable, suited for both indoor and outdoor use. It is lightweight, stain resistant and very easy to care for. While being produced to be UV resistant, prolonged exposure to sunlight should still be avoided.

Due to the handcrafted nature of our products, each item will vary slightly. We consider this a sign of uniqueness and quality.

Our sustainability commitment

As a vertically integrated company, we know we are in a unique position to contribute to a sustainable shift in the industry.

From design to the sourcing of raw materials, packaging and testing, we pay great attention to environmental protection and consumer safety throughout the product-development process. As a company, we work to minimise waste and close the loop toward circularity. Together with our partners, we strive to do our humble share.

Just as society and the industry evolve, so do we. We know there is no finish line in this journey and continue our efforts to constantly improve our products and operations.

We believe that durability and sustainability start with choosing the right quality material, and wooden products are particularly suited for refurbishment.

DURABILITY BY DESIGN

We pay particular attention to the quality of our products, not only during the development stage, but throughout the entire life cycle. We believe that durability and sustainability start with choosing the right quality material, and wooden products are particularly suited for refurbishment.

Our team is always available to advise on how to care for products and thus extend their lifespan, as well as how to repair them. When developing new products, we consider repairability at the earliest design stage. Where possible, we provide spare parts to further extend the life of our products.

THE ORIGIN OF OUR WOOD

The ultimate noble and renewable material, all our wood is sourced from responsibly and carefully managed forests compliant with the EU Timber Regulations and the Forest Law Enforcement, Governance and Trade (FLEGT) Action Plan. In addition, our wood sourced from Indonesia is verified under the Indonesian Timber Legality Assurance System (SVLK).

Our teak collection includes products certified as FSC® which are clearly labelled in the catalogue. Finally, we carry the FSC® CoC (Chain of Custody) certification of our distribution centres.

FOCUS ON QUALITY

Producing furniture and accessories at the highest quality, strength and safety is extremely important to us. Our internal protocols are based on the standards set by ANSI (American National Standards Institute) and BIFMA (North American Business and Institutional Furniture Manufacturers Association).

Moreover, specific products within our collections are certified by independent external facilities in order to meet the European requirements for contract-grade use. Products also meet specific requirements based around ecological and health regulations such as toxic substance use and flammability.

WASTE REDUCTION AND CIRCULARITY

We want to remain as environmentally friendly as possible, working to reduce waste from the earliest design stage. With this principle, we design to reduce or reuse as much scrap wood as possible. Production waste such as leftover logs, wood and sawdust are reused for other purposes.

With full control over the (re)design, production, distribution, refurbishing and recycling processes, we are developing a vision for sustainability based on designing for circularity and lengthening product lifespans.

Read more about our sustainability actions by scanning the QR code below:



credits

LIFESTYLE PHOTOGRAPHY

Nicolas Schimp
Frédéric Raevens
Diane Hendrixx

PRODUCT PHOTOGRAPHY

Diane Hendrixx
Thomas Ost

STYLING

Cécile Grosjean
Pauline Duchatelet

GRAPHIC DESIGN

Nancy Reijnders

©2023 Ethnicraft

ethnicraft.com

Ethnicraft



RETAIL

Ethnicraft Belgium

Headquarters & Showroom
(for professionals & by appointment only)
Scheldeweg 5
2850 Boom
+ 32 3 443 01 00
info@ethnicraft.com
RPR/RPM Antwerpen 0458.213.251

Ethnicraft France, Italy, Spain & Portugal

189, Rue Gabriel Lippmann CS90009
13131 Berre l'Etang CEDEX
+ 33 442 152 152
azur@ethnicraft.com

Ethnicraft Asia

info@ethnicraft-asia.com

Ethnicraft USA

730 Taylor Ave
High Point, NC. 27260
+ 1 336 821 1385
info@ethnicraft-usa.com



OFFICE, CONTRACT & TRADE PROFESSIONALS

Ethnicraft Europe, Middle East & Africa

+ 32 3 443 01 72
contract@ethnicraft.com
RPR/RPM Antwerpen 0846.804.654

Ethnicraft France, Italy, Spain & Portugal

+ 33 442 152 154
contract@ethnicraft.fr

Ethnicraft Asia - Pacific

+ 32 3 443 01 72
contract@ethnicraft-asia.com

Ethnicraft Americas

+ 1 336 821 1395
contract@ethnicraft-usa.com

Chicago Showroom

(for professionals & by appointment only)
222 Merchandise Mart Plaza (Room #322)
Chicago, Illinois
+1 973 907 6398
contract@ethnicraft-usa.com

ONLINE

ethnicraft.com

