

**Vol. 1**  
Sofas Collection

Rewind



 **maxdivani**

**Vol. 1**  
Sofas Collection



 maxdivani

 maxdivani

 maxdivani

 maxdivani





# Una storia solida ed elegante

A solid and elegant history — Une histoire solide et élégante, comme ses canapés

**ITA — MaxDivani disegna e realizza Divani Italiani da oltre 60 anni. La nostra storia svela la raffinata cura alla base dei nostri Divani Artigianali.**

**ENG — MaxDivani has designed and created 100% Italian sofas for over 60 years. Our heritage shows the refined care we put into our handcrafted sofas.**

**FR — MaxDivani conçoit et réalise des canapés italiens depuis plus de 60 ans. Notre histoire révèle le soin raffiné avec lequel sont fabriqués nos canapés artisanaux.**



**ITA — La nostra storia comincia oltre mezzo secolo fa, ad Altamura, in quello che, grazie alla passione e all'operosità dei suoi lavoratori, è riconosciuto come il distretto del mobile imbottito murgiano.**

**ENG — Our history began over half a century ago in Altamura, a place that, thanks to its workers' passion and toil, has been recognised as being the upholstered furniture district of Murgia.**

**FR — Notre histoire commence il y a plus d'un demi-siècle à Altamura, dans ce qu'on appelle, grâce à la passion et au travail constant de ses travailleurs, le district des canapés et fauteuils de Murgia.**

**Qui, nel 1956, il suo fondatore, Rocco Ferri, ha dato vita a MaxDivani, l'azienda che in poco tempo si è affermata per la qualità superiore espressa dai suoi divani artigianali.**

**It was here in 1956 that the founder, Rocco Ferri, began MaxDivani, a company that affirmed itself immediately for its higher quality handcrafted sofas.**

**C'est ici qu'en 1956, son fondateur Rocco Ferri a donné vie à MaxDivani, l'entreprise qui, en très peu de temps, s'est imposée pour la qualité supérieure de ses canapés artisanaux.**





# 100% Made in Italy

100% Italian sofas — Canapés 100 % Italiens

ENG — The handcrafted MaxDivani sofas are completely created in Italy. Discover the unique comfort of the [100% Italian sofas](#).

FR — Es Canapés Artisanaux Maxdivani sont entièrement fabriqués en Italie. Découvrez le confort unique des [canapés 100 % Italiens](#).

ITA — I Divani Artigianali di MaxDivani sono completamente realizzati in Italia. Scopri il [Comfort unico dei Divani Italiani al 100%](#).



ITA — [Una staffetta dritta al traguardo dell'eccellenza.](#)  
I divani Made in Italy MaxDivani sono il risultato di un appassionato passaggio di testimone tra designer, progettisti, falegnami, fabbri e tappezzieri. Ogni protagonista mette in gioco tutte le sue potenzialità creative e operative per dar vita ad un prodotto curato e testato per essere resistente e confortevole, piacevole e definito, rispettoso della lezione della tradizione, con lo sguardo rivolto al futuro.

ENG — [A race which arrives right to the finish line of excellence.](#)

The Made in Italy sofas by Maxdivani are the result of a passionate passing of the baton between designers, engineers, carpenters, blacksmiths and upholsterers. Each person plays a significant role, putting all their creative and operational potential into the company to create a product which has been thoroughly tested to be durable and comfortable, enjoyable and defined, following the tradition but gazing towards the future.

FR — [Un relais directement à l'étape de l'excellence.](#)

Les canapés Made in Italy Maxdivani sont le résultat d'un passage passionné de témoin entre les concepteurs, les ingénieurs, les charpentiers, les forgerons et les tapissiers. Chaque protagoniste met en jeu tout son potentiel créatif et opérationnel pour créer un produit soigné et testé pour être durable et confortable, agréable et défini, respectueux de la tradition tout en ayant un œil vers l'avenir.

# Tutto il valore di casa nostra per dare valore a casa tua

The value of our home to give value to yours  
— Toute la valeur de notre maison pour donner de la valeur à votre maison

ITA — L'idea progettuale continua a correre trasportata all'esperienza dei maestri falegnami, a cui è affidata la realizzazione del fusto in legno. Allo scheletro portante dei nostri divani artigianali, assemblati a mano, viene aggiunta una morbida anima modellata sulle forme del singolo esemplare e bilanciata tra poliuretano espanso e piume d'oca, per assicurare il massimo comfort.



ENG — The project continues to pass into the experience of the master carpenters who are entrusted with the creation of the wooden framing.

The supporting skeleton of our handmade sofas are assembled by hand, consequently a soft core is modelled into the single specimen models, creating a balance between polyurethane foam and goose-feather filling to ensure maximum comfort.

FR — L'idée du projet continue d'avancer, transportée vers l'expérience des maîtres charpentiers, à qui est confiée la réalisation du cadre en bois.

Au squelette porteur de nos canapés artisanaux, assemblés à la main, s'ajoute une âme souple modelée sur les formes du prototype et équilibrée entre la mousse de polyuréthane et les plumes d'oie, pour assurer un maximum de confort.





# Index

---



**Ever**

→ 012



**Albachiara**

→ 026



**Nando**

→ 038



**Groove**

→ 052



**Tortona**

→ 062



**Autografo**

→ 074



**Grace**

→ 090



**Ingrid**

→ 098



**Diva**

→ 110



**Gran Torino**

→ 120



**Ida**

→ 130



**Blow**

→ 140



**Amico**

→ 148

---

## **Technical Info**

→ 160





**Perfezione  
nelle geometrie**



# Ever

**Versatilità e funzionalità — Versatility and functionality**  
La polyvalence et la fonctionnalité

ITA — Il modello EVER è un salotto a moduli separati adattabile ad ogni ambiente, rivestito in velluto di puro cotone con effetto stone washed. Grazie alla sua combinazione di movimenti separati di spalliere e braccioli, può essere configurato rispettando ogni esigenza di comodità e gusto.

ENG — Model EVER has a modular seating suitable for any kind of interior; it is covered in a stonewashed effect velvet fabric made of pure cotton. Thanks to the combination of independent movements of the armrests as well as the backrests, it can be assembled in several configurations in accordance with different requirements of taste and comfort.

FR — Le modèle EVER est un salon modulable, adaptable à tous les intérieurs, recouvert de velours de coton avec un effet délavé. Grâce à sa combinaison de mouvements séparés dos et accoudoirs, il peut être configuré selon toutes les exigences de confort et de goût.







Mod. Ever  
Versioni 520 - 125 - 125 - 417 - 113  
Salotto angolare in velluto.





— Mod. **Ever**  
Versioni 520 - 125 - 417 - 125 - 113  
Salotto angolare in velluto.



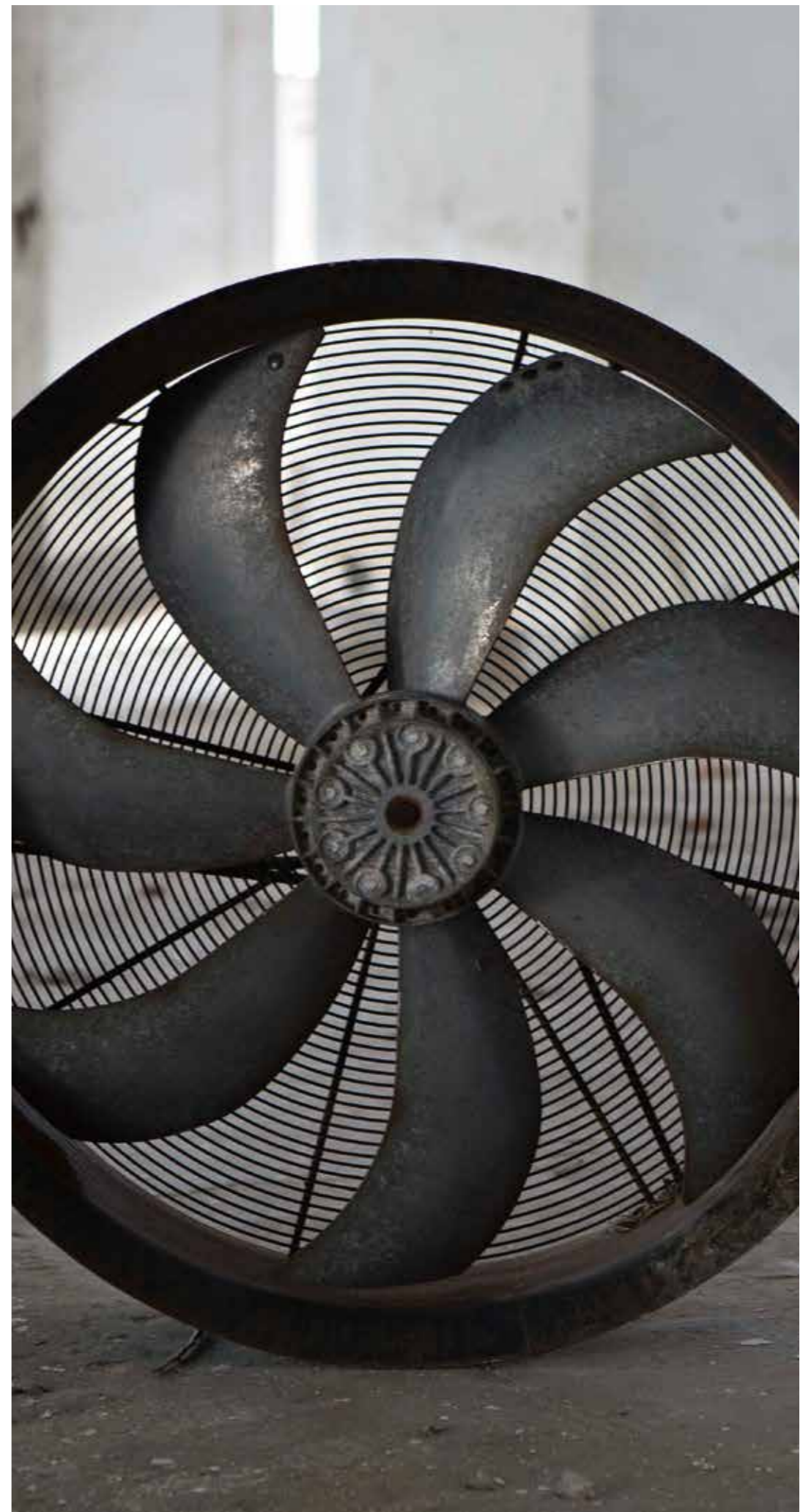





— Mod. Ever  
Versioni 125 - 417 - 125 - 113  
Salotto angolare  
in pelle pura anilina.







## Ever



### — Rivestimento

Pelle / Tessuto

### — Imbottitura

BRACCIOLI / Poliuretano espanso

SEDUTA / Poliuretano espanso

SPALLIERA / Poliuretano espanso

— **Opzioni** Cucitura a contrasto

— **Comfort** Standard

— **Piedi** Plastica

— **Struttura** Telaio in ferro

### — Coverings

Leather / Fabric

### — Filling

ARMS / Foam

SEAT CUSHION / Foam

BACK CUSHION / Foam

— **Options** Contrast stitching

— **Comfort** Standard

— **Legs** Plastic

— **Structure** Iron frame

### — Revêtement

Cuir / Tissu

### — Rembourrage

ACCOUDOIRS / Mousse

ASSISE / Mousse

DOSSIER / Mousse

— **Options** Coutures contrastées

— **Comfort** Standard

— **Pieds** Plastique

— **Structure** Structure en fer

### — Revestimiento

Piel / Tela

### — Imbottitura

APOYABRAZOS / Poliuretano expandido

SENTADA / Poliuretano expandido

RESPALDO / Poliuretano expandido

— **Opciones** Costura en contraste

— **Confort** Estándar

— **Pies** Plastico

— **Struttura** Estructura en hierro

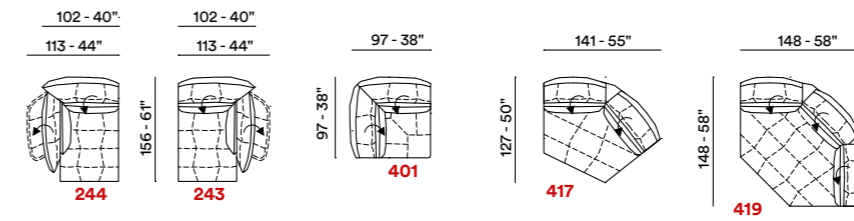
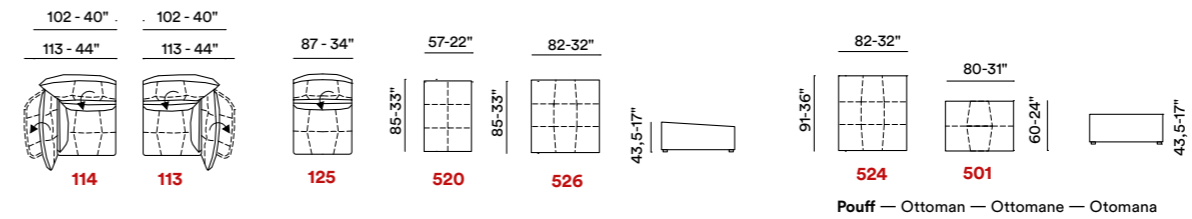

Esempi di componibilità — Sectionals examples — Exemples de compositions — Ejemplos de modularidad

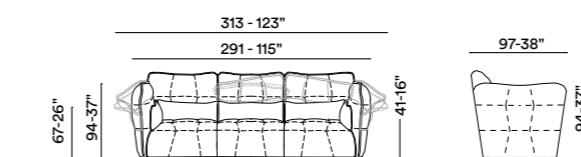
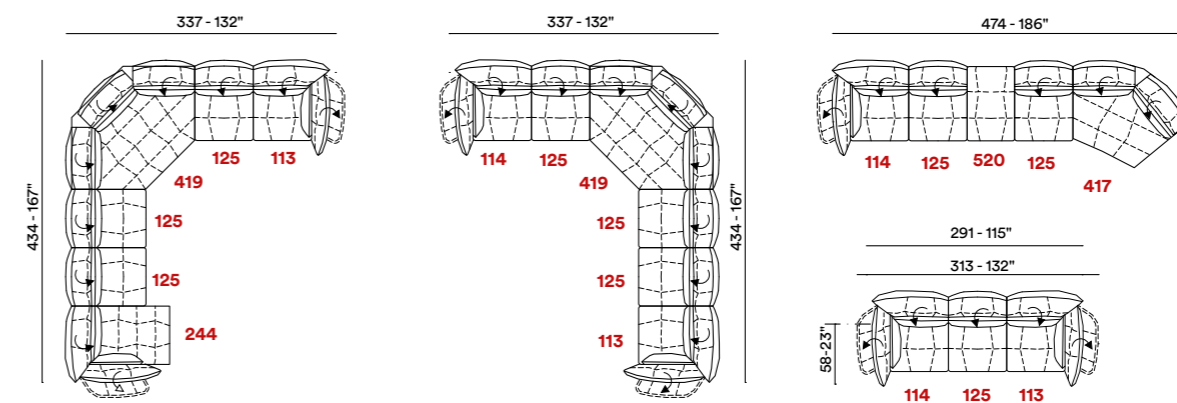



# Certezza nel tempo





# Albachiara

Un design dalle linee accoglienti — A design with welcoming lines  
Un design aux lignes accueillantes

ITA — Un grande divano rivestito in pelle pura anilina con 3 mm di spessore e dalla seduta ampia e comoda. Realizzato con imbottiture in poliuretano espanso e piuma d'oca, il divano Albachiara ha un design dalle linee accoglienti che invitano al relax e alla convivialità.

La struttura metallica, rivestita in cuoietto, poggia su solide slitte in acciaio cromo lucido. Sono disponibili pouf biposto e cuscini quadrati in lana, accessori coordinati per completare il disegno di un esclusivo salotto dallo stile Italiano.

ENG — A large sofa upholstered in 3mm-thick pure aniline leather with wide, comfortable seat cushions. Padded with polyurethane foam and goose down, the cosy lines of the Albachiara sofa invite you to relax and spend time with friends and family.

The metal, leather-upholstered frame rests on top of solid shiny chrome steel sleigh legs. Matching double footstools and square woollen cushions are available to complete the exclusive Italian-style living room look.

FR — Un grand canapé revêtu de cuir pur aniline avec 3 mm d'épaisseur et à l'assise large et confortable. Fabriqué avec de la mousse de polyuréthane et de la plume d'oie, le canapé Albachiara a un design aux lignes agréables qui invitent à la détente et à la convivialité.

La structure métallique, recouverte de cuir, repose sur de solides glissières en acier chromé poli. Un pouf deux places et des coussins carrés en laine sont disponibles, accessoires assortis pour compléter le design d'un salon exclusif au style italien.







— Mod. Albachiera  
Versioni 300  
Divano 4 posti in pelle.













— Mod. Albachiera  
Versioni 308  
Divano 3 posti  
in pelle pura anilina.





# Albachiara



## — Rivestimento

Pelle / Tessuto

## — Imbottitura

BRACCIOLI / Poliuretano espanso - Piuma

SEDUTA / Poliuretano espanso - Piuma

SPALLIERA / Poliuretano espanso - Piuma

— **Opzioni** Cucitura a contrasto

— **Comfort** Standard - Rigido

— **Piedi** Metallo

— **Struttura** Telaio in ferro e legno

## — Coverings

Leather / Fabric

## — Filling

ARMS / Foam - Feather

SEAT CUSHION / Foam - Feather

BACK CUSHION / Foam - Feather

— **Options** Contrast stitching

— **Comfort** Standard - Hard

— **Legs** Metal

— **Structure** Iron and wooden frame

## — Revêtement

Cuir / Tissu

## — Rembourrage

ACCOUDOIRS / Mousse - Plumes

ASSISE / Mousse - Plumes

DOSSIER / Mousse - Plumes

— **Options** Coutures contrastées

— **Confort** Standard - Fermé

— **Pieds** Metal

— **Structure** Structure en bois et fer

## — Revestimiento

Piel / Tela

## — Imbottitura

APOYABRAZOS / Poliuretano expandido - Piuma

SENTADA / Poliuretano expandido - Piuma

RESPALDO / Poliuretano expandido - Piuma

— **Opciones** Costura en contraste

— **Confort** Estándar - Duro

— **Pies** Metal

— **Struttura** Estructura en madera y hierro

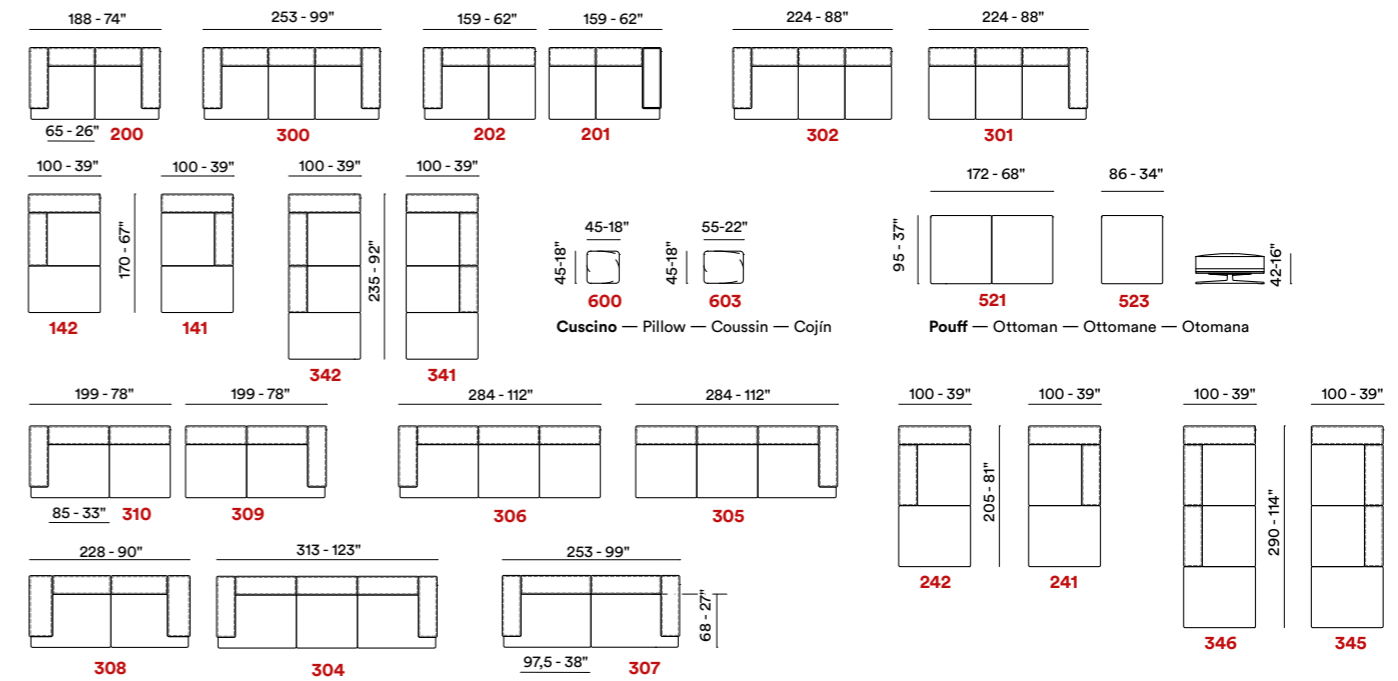

## Esempi di componibilità — Sectionals examples — Exemples de compositions — Ejemplos de modularidad

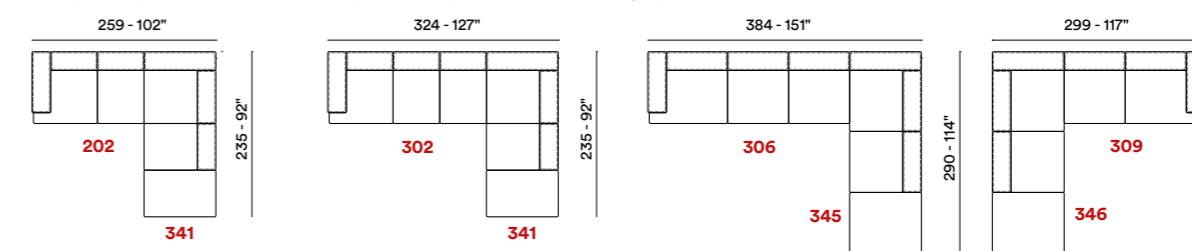

— **Modello brevettato** — Patented model

Finitura piedi — Legs finishes — Finition de pieds — Acabados de pies

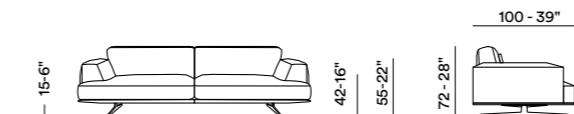



# Nando

**Eccellenza di materiali — Materials excellence**  
Excellence des matériaux

ITA — Nando è il salotto angolare che si distingue per i volumi di spalliere e braccioli e per l'ampia seduta comoda e avvolgente.

Rivestito in pelle all'anilina, il divano Nando combina l'eccellenza di materiali, forme e comfort, proiettandosi verso una dimensione di stile moderna e ricercata con le sue cuciture a taglio vivo.

ENG — The spacious backrest and arms, as well as comfortable and enveloping seat, make this corner sofa stand out.

Nando sofa is finished in aniline leather and brings together superb materials, shape and comfort. Finished with raw-edge stitching, it evinces a modern and refined sense of style.

FR — Nando est le salon d'angle se distinguant par les volumes de ses dossiers et accoudoirs et par une assise confortable et moelleuse.

Recouvert de cuir aniline, le canapé Nando combine l'excellence des matériaux, des formes et du confort, pour un design au style moderne et sophistiqué, avec sa coupe nette des coutures.







— Mod. Nando  
Versioni 310 - 341  
Salotto angolare rivestito  
in pelle pura anilina  
con imbottiture in piuma d'oca.



## Lavorazione Made in Italy

Italian-made workmanship  
— Italian-made workmanship

ITA — L'originale lavorazione Made in Italy riserva un prezioso segreto di stile: il retro della spalliera è impreziosito da particolari bombature, realizzate attraverso un'accurata lavorazione sulla pregiata imbottitura di piuma d'oca.

ENG — Its Italian-made workmanship also holds a hidden design element: the careful finishing done over its luxurious goose-down filling embellishes the back, giving it a unique curved profile.

FR — La finition originale Made in Italy révèle un précieux secret de style: l'arrière du dossier est orné de cambrures spéciales, créées par une fabrication soignée sur le garnissage raffiné en duvet d'oie.



— Mod. Nando  
Versioni 310 - 341  
Salotto angolare rivestito in pelle  
pura anilina con imbottiture  
in piuma d'oca.





— Mod. Nando  
Versioni 308  
Divano in pelle pura anilina.



— Mod. **Nando**  
Versioni 310 - 243  
Divano con chaise longue in tessuto.







## Nando



### — Rivestimento

Pelle / Tessuto

### — Imbottitura

BRACCIOLI / Poliuretano espanso - Piuma

SEDUTA / Poliuretano espanso - Piuma

SPALLIERA / Poliuretano espanso - Piuma

— **Opzioni** Cucitura a contrasto

— **Comfort** Standard

— **Piedi** Metallo

— **Struttura** Telaio in ferro e legno

### — Coverings

Leather / Fabric

### — Filling

ARMS / Foam - Feather

SEAT CUSHION / Foam - Feather

BACK CUSHION / Foam - Feather

— **Options** Contrast stitching

— **Comfort** Standard

— **Legs** Metal

— **Structure** Iron and wooden frame

### — Revêtement

Cuir / Tissu

### — Rembourrage

ACCOUDOIRS / Mousse - Plumes

ASSISE / Mousse - Plumes

DOSSIER / Mousse - Plumes

— **Options** Coutures contrastées

— **Confort** Standard

— **Pieds** Metal

— **Structure** Structure en bois et fer

### — Revestimiento

Piel / Tela

### — Imbottitura

APOYABRAZOS / Poliuretano expandido - Piuma

SENTADA / Poliuretano expandido - Piuma

RESPALDO / Poliuretano expandido - Piuma

— **Opciones** Costura en contraste

— **Confort** Estándar

— **Pies** Metal

— **Struttura** Estructura en madera y hierro

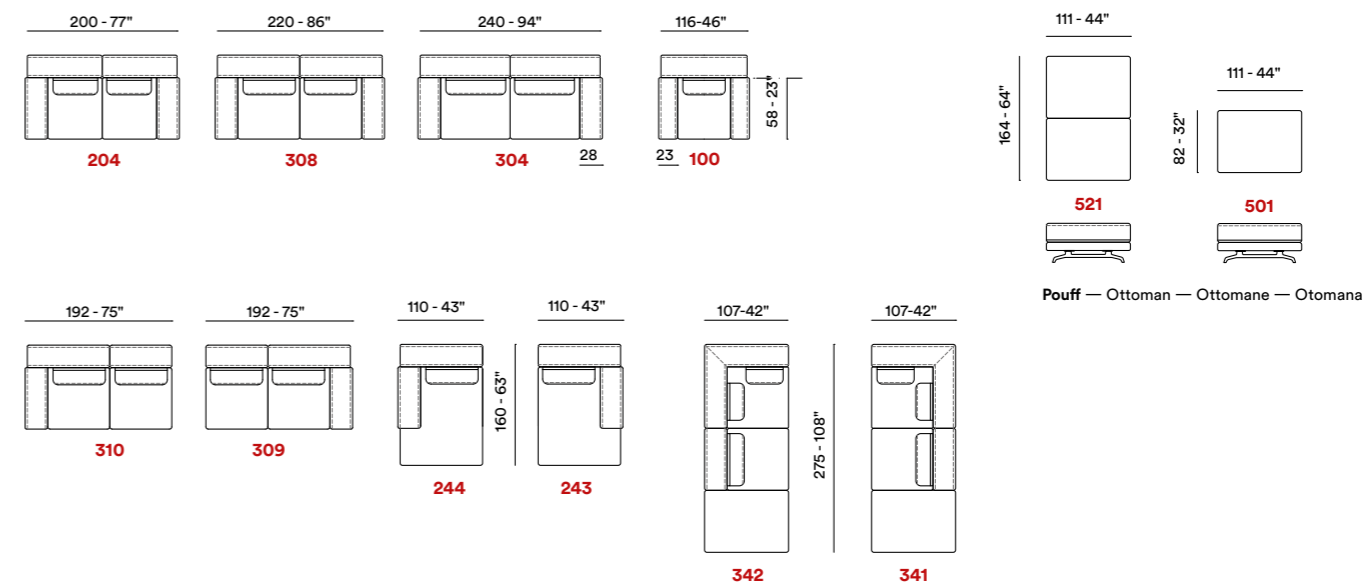

Esempi di componibilità — Sectionals examples — Exemples de compositions — Ejemplos de modularidad

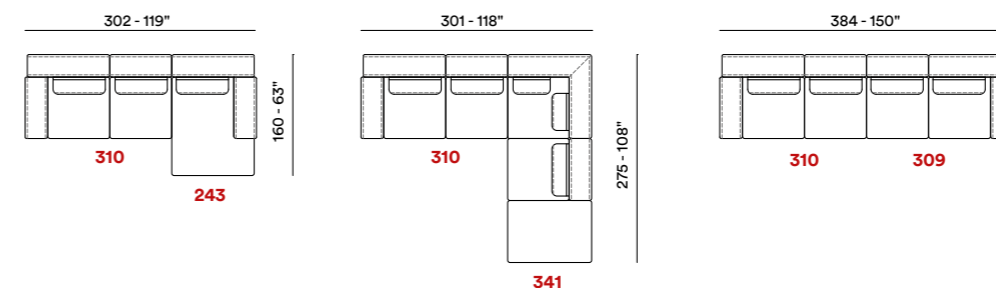

— Modello brevettato — Patented model

Finitura piedi — Legs finishes — Finition de pieds — Acabados de pies

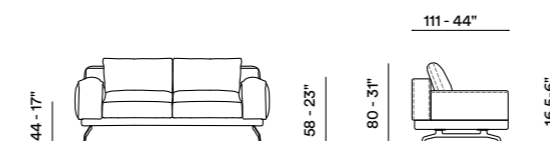



Le tue  
passioni  
ovunque





# Groove

Rigore artigianale Made in Italy — Hand-crafted rigour Made in Italy  
Une rigueur artisanale Made in Italy

ITA — Un armonioso dialogo di volumi squadrate è il tratto distintivo del divano tre posti maxi GROOVE, espressione di rigore artigianale Made in Italy.

Dalla cucitura pizzicata che ne definisce tutte le componenti imbottite alla sagoma dei piedini metallo in finitura ferro calamina: GROOVE si distingue per gli originali dettagli delle finiture, che ne fanno un prodotto di prestigio ed eleganza senza tempo

ENG — A harmonious dialogue of squared volumes is the distinctive feature of the three-seater maxi sofa GROOVE, an expression of hand-crafted masterpiece Made in Italy.

From the pinched seam that defines all of its padded components to its feet with calamine finishing color: GROOVE stands out for the original details of its lines, which make it a prestigious product of timeless elegance.

FR — Un dialogue harmonieux entre des volumes aux formes carrées caractérise le canapé trois places maxi GROOVE, en exprimant toute la rigueur artisanale du Made in Italy.

GROOVE se distingue grâce aux détails originaux de ses finitions, telles que les coutures pincées sur tous les coussins, les pieds en métal finition couleur calamine, pour un canapé prestigieux d'une élégance intemporelle.







— Mod. Groove  
Versione 300  
Divano 4 posti in pelle.





ITA — Collocato su una base in struttura mista metallo e legno, questo modello è dotato di spalliere con sistema a pistoni azionabile manualmente, che consente di aumentarne l'altezza. Ulteriore dettaglio comfort è da individuarsi nei poggiatesta in piuma d'oca, compresi nel divano.

ENG — Placed on a base made of metal and wood, this model features backrests with a manually operated piston system which makes it possible to increase its height. Other elements that increase the comfort of this sofa are the goose down lumbar pillows, included with the sofa.

FR — Ce modèle reposant sur un piètement mêlant le métal et le bois est pourvu de dossiers avec systèmes à piston actionnés manuellement, qui permettent d'augmenter leur hauteur. Les coussins cale-rein en plumes d'oie compris avec le canapé ajoutent une touche de confort supplémentaire.





— Divano mod. **Groove**  
Versioni 308 - 300  
Divano 3 posti in tessuto  
e divano 4 posti in pelle.  
Cuscini cod. C1039.

— Tavolino mod. **Procida**  
Fin 41/91.





— Mod. **Groove**  
Versione 300  
Divano 4 posti in pelle.



## Groove



### — Rivestimento

Pelle / Tessuto

### — Imbottitura

BRACCIOLI / Poliuretano espanso  
SEDUTA / Poliuretano espanso - Piuma  
SPALLIERA / Poliuretano espanso - Piuma

— **Opzioni** Cucitura a contrasto

— **Comfort** Standard

— **Piedi** Metallo

— **Struttura** Telaio in ferro e legno

### — Coverings

Leather / Fabric

### — Filling

ARMS / Foam  
SEAT CUSHION / Foam - Feather  
BACK CUSHION / Foam - Feather

— **Options** Contrast stitching

— **Comfort** Standard

— **Legs** Metal

— **Structure** Iron and wooden frame

### — Revêtement

Cuir / Tissu

### — Rembourrage

ACCOUDOIRS / Mousse  
ASSISE / Mousse - Plumes  
DOSSIER / Mousse - Plumes

— **Options** Coutures contrastées

— **Comfort** Standard

— **Pieds** Metal

— **Structure** Structure en bois et fer

### — Revestimiento

Piel / Tela

### — Imbottitura

APOYABRAZOS / Poliuretano expandido  
SENTADA / Poliuretano expandido - Piuma  
RESPALDO / Poliuretano expandido - Piuma

— **Opciones** Costura en contraste

— **Comfort** Estándar

— **Pies** Metal

— **Struttura** Estructura en madera y hierro

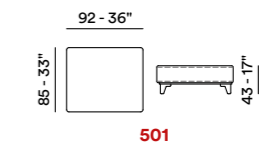
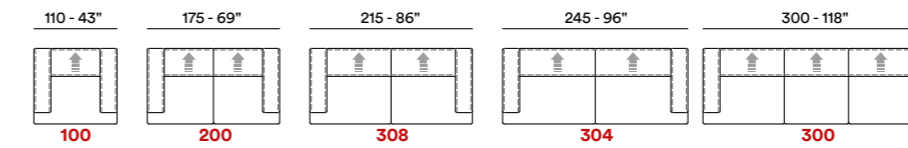

**501**  
Pouff — Ottoman — Ottomane — Otomana

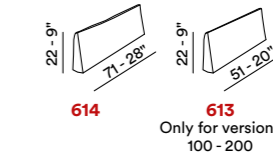
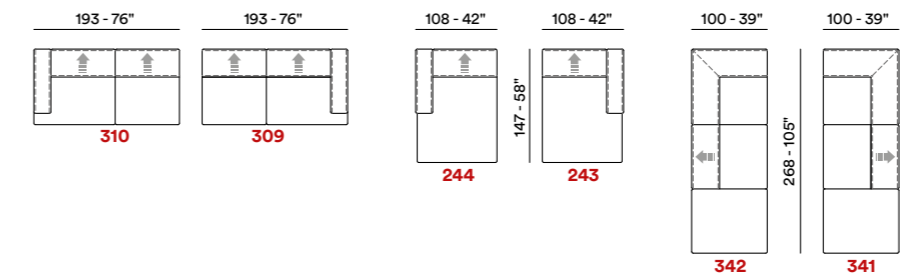

**614** **613**  
Only for versions 100 - 200

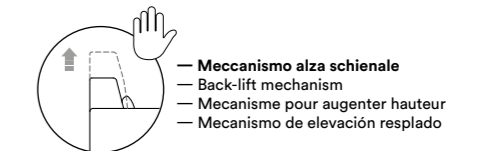

— **Meccanismo alza schienale**  
— Back-lift mechanism  
— Mecanisme pour augmenter hauteur  
— Mecanismo de elevación respaldo

### Esempi di componibilità — Sectionals examples — Exemples de compositions — Ejemplos de modularidad

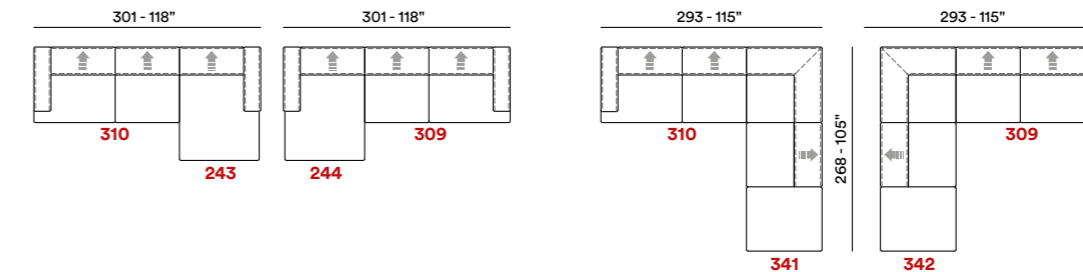

### — Modello brevettato — Patented model

### Finitura piedi — Legs finishes — Finition de pieds — Acabados de pies

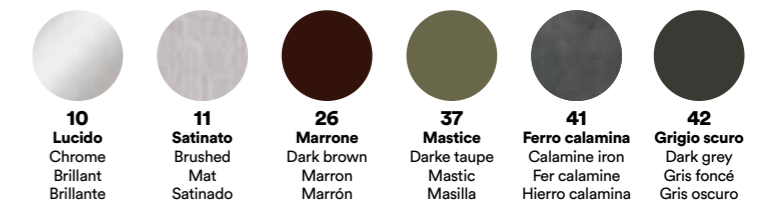
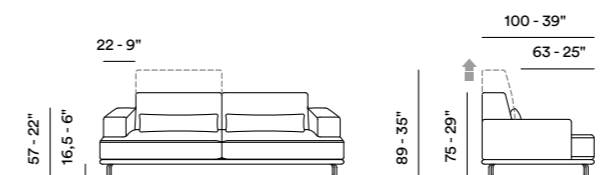



# Tortona

Stile ricercato — Sophisticated style  
Style sophistiqué

ITA — Tortona è il divano angolare MaxDivani che fonde al meglio stile ricercato, puro design italiano e praticità di utilizzo, per realizzare un salotto da vivere non solo con gli occhi.

Le linee essenziali e l'abbraccio morbido di questo divano in tessuto completamente sfoderabile, insieme alle imbottiture in piuma d'oca, lo rendono pronto per diventare il centro di un caldo momento di convivialità. Valore aggiunto, le tante possibilità di personalizzazione con una serie di cuscini declinabili in vari rivestimenti e colori.

ENG — Tortona is the MaxDivani corner sofa that blends inimitable and refined style with ease-of-use and total Italian design. It creates a sitting room that's much more than simply nice to look at.

With its clear lines, enfolding softness, completely removable cover and goose down filling, this fabric sofa is destined to become a warm social gathering place in your home. A variety of customisation options, including pillows available in various finishes and colours, offer an added advantage.

FR — Tortona est le canapé d'angle Maxdivani qui fusionnant au mieux le style recherché, le pur design italien et la facilité d'utilisation, pour réaliser un salon à vivre, et pas seulement avec les yeux.

Les lignes épurées et la douce étreinte de ce canapé complètement amovible, ensemble avec le rembourrage en plumes d'oie, font qu'il est prêt à devenir le centre d'un moment chaleureux de convivialité. Valeur ajoutée, de grandes possibilités de personnalisation avec une gamme de coussins déclinables en différentes finitions et couleurs.











— Divano Mod. **Tortona**  
Versioni 310 - 341  
Salotto angolare in tessuto sfoderabile.

— Tavolino Mod. **Tremiti**  
finitura 41/91.









— Mod. Tortona  
Versioni 308  
Divano 3 posti  
in tessuto sfoderabile.





# Tortona



- |   |  |   |   |
|---|--|---|---|
| <p>— <b>Rivestimento</b><br/>Tessuto sfoderabile</p> <p>— <b>Imbottitura</b><br/>BRACCIOLI / Poliuretano espanso<br/>SEDUTA / Poliuretano espanso - Piuma<br/>SPALLIERA / Piuma</p> <p>— <b>Opzioni</b> Cucitura a contrasto</p> <p>— <b>Comfort</b> Standard</p> <p>— <b>Piedi</b> Metallo</p> <p>— <b>Struttura</b> Telaio in ferro e legno</p> | <p>— <b>Coverings</b><br/>Fabric removable</p> <p>— <b>Filling</b><br/>ARMS / Foam<br/>SEAT CUSHION / Foam - Feather<br/>BACK CUSHION / Feather</p> <p>— <b>Options</b> Contrast stitching</p> <p>— <b>Comfort</b> Standard</p> <p>— <b>Legs</b> Metal</p> <p>— <b>Structure</b> Iron and wooden frame</p> | <p>— <b>Revêtement</b><br/>Tissu déhoussable</p> <p>— <b>Rembourrage</b><br/>ACCOUDOIRS / Mousse<br/>ASSISE / Mousse - Plumes<br/>DOSSIER / Plumes</p> <p>— <b>Options</b> Coutures contrastées</p> <p>— <b>Comfort</b> Standard</p> <p>— <b>Pieds</b> Metal</p> <p>— <b>Structure</b> Structure en bois et fer</p> | <p>— <b>Revestimiento</b><br/>Tela extraíble</p> <p>— <b>Imbottitura</b><br/>APOYABRAZOS / Poliuretano expandido<br/>SENTADA / Poliuretano expandido - Piuma<br/>RESPALDO / Piuma</p> <p>— <b>Opciones</b> Costura en contraste</p> <p>— <b>Confort</b> Estándar</p> <p>— <b>Pies</b> Metal</p> <p>— <b>Struttura</b> Estructura en madera y hierro</p> |
|---|--|---|---|

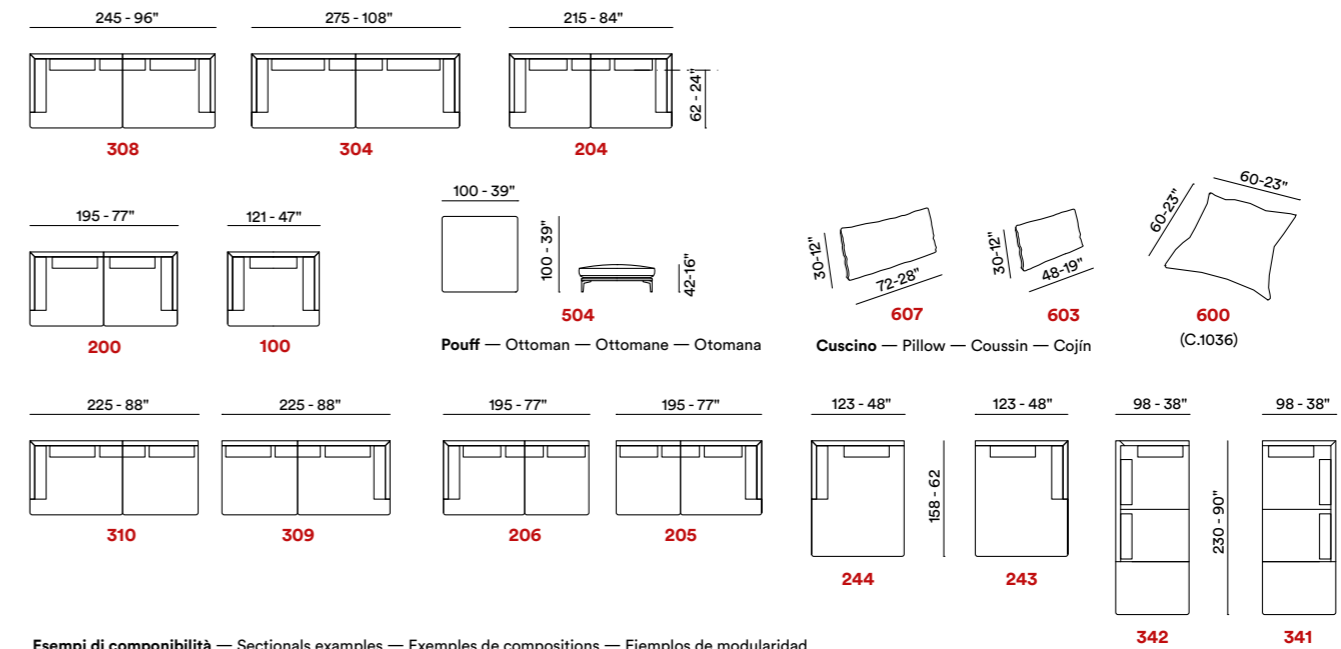

Esempi di componibilità — Sectionals examples — Exemples de compositions — Ejemplos de modularidad

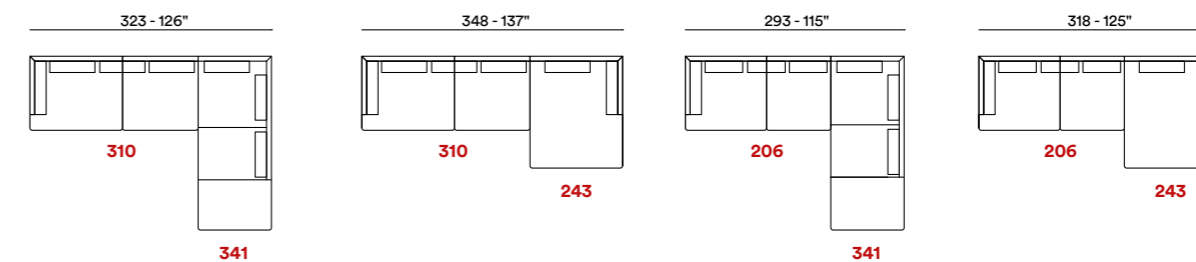

Finitura piedi — Legs finishes — Finition de pieds — Acabados de pies

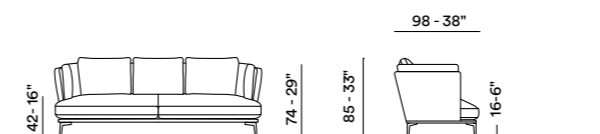

- |  |   |   |
|--|---|---|
|  |   |   |
| <b>10</b><br>Lucido<br>Chrome<br>Brillant<br>Brillante | <b>11</b><br>Satinato<br>Brushed<br>Mat<br>Satinado | <b>22</b><br>Bronzato<br>Bronze<br>Bronze<br>Bronce |



# Autografo

Esperienza di stile esclusiva — A unique style experience  
Exemple d'excellence artisanale

ITA — Autografo è il divano artigianale che rinnova la classicità del modello Chesterfield, disvelandone nuove qualità attraverso la cura e la creatività del design Made in Italy.

Con i suoi tre posti, il divano MaxDivani offre un'esperienza di stile esclusiva: un manto di velluto va a rivestire il resistente scheletro in legno massello e la flessuosa anima in poliuretano espanso e piuma d'oca, dando nuova vita ad un must del relax.

ENG — Autografo is a handcrafted version of the classic Chesterfield sofa that has been carefully and creatively modernised with new features distinctive of the Made In Italy trademark.

This three-seater MaxDivani sofa offers an exclusive style experience: the sturdy solid wood frame and supple body made of foam and goose down are covered in a velvet cloak, breathing new life into a piece of furniture that helps you unwind.

FR — Autografo est un canapé artisanal qui renouvelle le classicisme du modèle Chesterfield, en révélant la nouvelle qualité grâce au soin et la créativité du design Made in Italy.

Avec ses trois sièges, le canapé Maxdivani offre une expérience de style unique : un manteau de velours recouvre la structure en bois massif ainsi que les assises en mousse et plumes d'oie, donnant de la sorte une nouvelle vie à un must de la détente.















— Mod. Autografo  
Versioni 304  
Divano 4 posti in velluto.





— Mod. **Autografo**  
Versioni 304  
Divano 4 posti in pelle.











## Autografo



— **Rivestimento**

Pelle / Tessuto

— **Imbottitura**

BRACCIOLI / Poliuretano espanso  
 SEDUTA / Poliuretano espanso - Piuma  
 SPALLIERA / Poliuretano espanso

— **Opzioni** Cucitura a contrasto

— **Comfort** Standard

— **Piedi** Plastica

— **Struttura** Telaio in legno

— **Coverings**

Leather / Fabric

— **Filling**

ARMS / Foam  
 SEAT CUSHION / Foam - Feather  
 BACK CUSHION / Foam

— **Options** Contrast stitching

— **Comfort** Standard

— **Legs** Plastic

— **Structure** Wooden frame

— **Revêtement**

Cuir / Tissu

— **Rembourrage**

ACCOUDOIRS / Mousse  
 ASSISE / Mousse - Plumes  
 DOSSIER / Mousse

— **Options** Coutures contrastées

— **Comfort** Standard

— **Pieds** Plastique

— **Structure** Structure en bois

— **Revestimiento**

Piel / Tela

— **Imbottitura**

APOYABRAZOS / Poliuretano expandido  
 SENTADA / Poliuretano expandido - Piuma  
 RESPALDO / Poliuretano expandido

— **Opciones** Costura en contraste

— **Comfort** Estándar

— **Pies** Plastico

— **Struttura** Estructura en madera

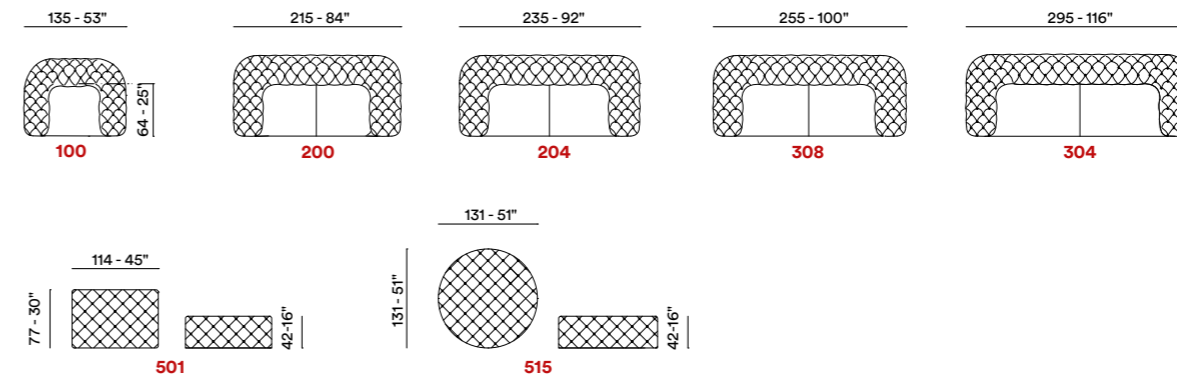

Pouff — Ottoman — Ottomane — Otomana

— **Modello brevettato** — Patented model

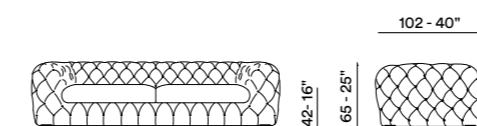



A pair of worn, dark brown wooden shoe lasts are positioned on a rustic wooden workbench. The lasts are shaped like shoes, with one slightly behind the other. The wood shows signs of use, with some scuffing and discoloration. In the background, a metal object, possibly a part of a shoe-making machine, is partially visible. The overall scene is lit with warm, natural light, highlighting the textures of the wood.

**La misura  
del comfort**



# Grace

Il chesterfield contemporaneo — The contemporary chesterfield  
Le chesterfield moderne

ITA — Salotto chesterfield rivisto in chiave contemporanea, eleganza, raffinatezza e cura dei dettagli sono alcuni dei tanti aspetti che connotano questo modello, a queste caratteristiche estetiche vanno aggiunte il confort della spalliera alta non sempre riscontrabile in salotti classici.

ENG — A chesterfield lounge in a contemporary key, elegance, sophistication and attention to detail are just some of the many aspects connoted by this model, qualities enhanced by the comfort of the high backrest, not always a feature of classic lounges.

FR — Canapé Chesterfield revisité en version contemporaine. Élégance, raffinement et soin des détails sont seulement quelques-uns des nombreux aspects distinguant ce modèle. À ces qualités esthétiques s'ajoute le confort offert par la hauteur du dossier, parfois difficile à trouver dans les canapés traditionnels.







— Mod. Grace  
Versioni 308 - 200  
Divano 3 posti e 2 posti  
in pelle pura anilina.



## Classico contemporaneo

Classic and contemporary — Classique et moderne



— Mod. **Grace**  
Versione 100  
Poltrona in pelle  
pura anilina.

ITA — Rivestito in pelle pura anilina dalla morbidezza unica del suo genere, Grace è un modello classico e contemporaneo facilmente inseribile in ogni contesto living.

ENG — Upholstered in pure aniline leather, featuring softness unique to its kind, Grace is a classic and contemporary model that can be easily placed in any living room.

FR — Revêtu en pur cuir aniline pour un moelleux unique, Grace est un modèle classique et moderne facile à insérer dans tous les styles de salons.







## Grace



### — Rivestimento

Pelle / Tessuto

### — Imbottitura

BRACCIOLI / Poliuretano espanso

SEDUTA / Poliuretano espanso

SPALLIERA / Poliuretano espanso

— **Opzioni** Cucitura a contrasto

— **Comfort** Standard / Rigido

— **Piedi** Legno con profilo in alluminio

— **Struttura** Telaio in legno

### — Coverings

Leather / Fabric

### — Filling

ARMS / Foam

SEAT CUSHION / Foam

BACK CUSHION / Foam

— **Options** Contrast stitching

— **Comfort** Standard / Hard

— **Legs** Wood with profile aluminium

— **Structure** Wooden frame

### — Revêtement

Cuir / Tissu

### — Rembourrage

ACCOUDOIRS / Mousse

ASSISE / Mousse

DOSSIER / Mousse

— **Options** Coutures contrastées

— **Confort** Standard / Fermé

— **Pieds** Bois avec insert en métal

— **Structure** Structure en bois

### — Revestimiento

Piel / Tela

### — Imbottitura

APOYABRAZOS / Poliuretano expandido

SENTADA / Poliuretano expandido

RESPALDO / Poliuretano expandido

— **Opciones** Costura en contraste

— **Confort** Estándar / Duro

— **Pies** Madera con perfil de aluminio

— **Struttura** Estructura en madera

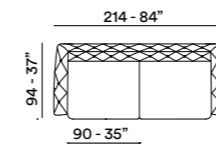

308

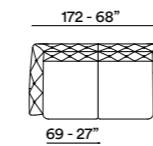

200

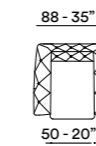

100

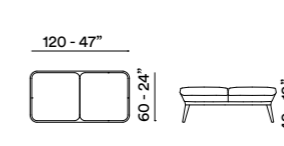

522

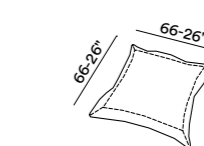

Cuscino — Pillow — Coussin — Cojín  
C.1033

— Modello brevettato — Patented model

Finitura piedi — Legs finishes — Finition de pieds — Acabados de pies



**26**  
Marrone  
Dark brown  
Marron  
Marrón



**37**  
Mastice  
Darke taupe  
Mastic  
Masilla



**42**  
Grigio scuro  
Dark grey  
Gris foncé  
Gris oscuro

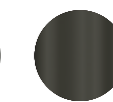

**46**  
Titanio  
Titanium  
Titane  
Titanio



# Ingrid

Un classico intramontabile — A timeless classic  
Un classique intemporel

ITA — Ingrid è il divano di qualità artigianale a tre posti che declina nel contemporaneo un classico intramontabile dell'arredamento, il divano in pelle Chesterfield.

Il divano Ingrid rappresenta la congiunzione tra la tradizionale lavorazione in pelle spessorata capitonnè e il design pulito e minimale, che rende questo modello capace di innovare ogni ambiente con una nota di gusto inedita.

ENG — Ingrid is the 3-seater with craftsmanship quality that redefines the contemporary, classic and timeless leather Chesterfield sofa.

The Ingrid sofa is the epitome of traditional tufted leatherwork and clean, minimal design, enabling this model to transform any room with its air of uncommonly good taste.

FR — Ingrid est le canapé de qualité artisanal à trois places qui décline dans un esprit contemporain, un classique intemporel du mobilier, le canapé Chesterfield en cuir.

Le canapé Ingrid représente la jonction entre le traitement traditionnel du cuir épais capitonné, et le design épuré et minimaliste, ce qui rend ce modèle capable d'innover chaque atmosphère avec une note de goût inédite.







— Divano mod. **Ingrid**  
Versione 304  
Divano 4 posti in pelle pura anilina.

— Tavolino mod. **Tremiti**  
Fin 10/91.









— Mod. Ingrid  
Versione 304  
Divano 4 posti in pelle.







# Ingrid



**— Rivestimento**

Pelle / Tessuto

**— Imbottitura**

BRACCIOLI / Poliuretano espanso

SEDUTA / Poliuretano espanso

SPALLIERA / Poliuretano espanso

**— Opzioni** Cucitura a contrasto

**— Comfort** Standard

**— Piedi** Metallo

**— Struttura** Telaio in legno

**— Coverings**

Leather / Fabric

**— Filling**

ARMS / Foam

SEAT CUSHION / Foam

BACK CUSHION / Foam

**— Options** Contrast stitching

**— Comfort** Standard

**— Legs** Metal

**— Structure** Wooden frame

**— Revêtement**

Cuir / Tissu

**— Rembourrage**

ACCOUDOIRS / Mousse

ASSISE / Mousse

DOSSIER / Mousse

**— Options** Coutures contrastées

**— Comfort** Standard

**— Pieds** Metal

**— Structure** Structure en bois

**— Revestimiento**

Piel / Tela

**— Imbottitura**

APOYABRAZOS / Poliuretano expandido

SENTADA / Poliuretano expandido

RESPALDO / Poliuretano expandido

**— Opciones** Costura en contraste

**— Confort** Estándar

**— Pies** Metal

**— Struttura** Estructura en madera

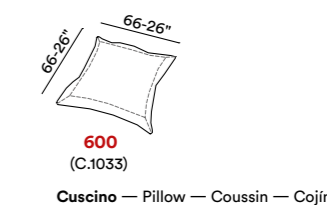
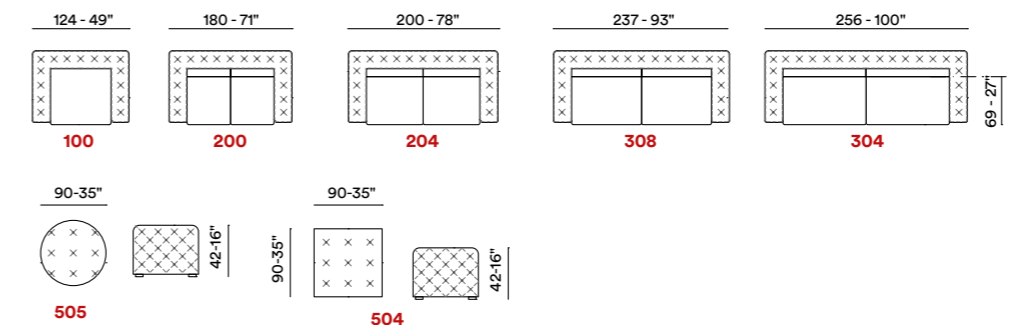

Pouff — Ottoman — Ottomane — Otomana

**Finitura piedi — Legs finishes — Finition de pieds — Acabados de pies**

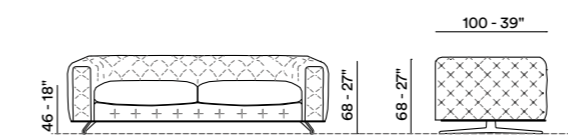

-  **10**  
Lucido  
Chrome  
Brillant  
Brillante
-  **11**  
Satinato  
Brushed  
Mat  
Satinado



A brown leather suitcase is open on a dark, textured floor. On top of the suitcase, there is a stack of several books with white covers. One book's spine is visible with the text "SOMMARIO DI DIALETTICA". A wooden tennis racket with a woven mesh head is leaning against the suitcase. The scene is lit from the side, creating strong shadows.

**Ovunque  
le tue  
passioni**



# Diva

Linee morbide ed avvolgenti — Soft and enveloping lines  
Lignes douces et enveloppantes

ITA — Diva è un divano 4 posti a 3 spalliere grandi in pelle che nasce con la voglia di accogliere, grazie all'abbraccio dei suoi braccioli inclinati ed esaltati dalla naturalezza del nabuk e alla ricercata stilizzazione dalla cucitura a taglio vivo.

A tre posti con penisola terminale, è un divano che si distingue per le sue linee morbide ed avvolgenti, nelle quali rifugiarsi se si è alla ricerca di una parentesi di puro relax.

ENG — Diva is a 4-seater sofa with 3 large leather backrests that was born with a welcoming desire, thanks to the wrapping of its slanted armrests and enhanced by the naturalness of nubuck and refined stylization of the sharp cut seam.

A three-seater with ending peninsula, it's a sofa standing out for its soft and enveloping lines, where you can rest if you are looking for a fully relaxing experience.

FR — Diva est un canapé 4 places à 3 grands dossiers en cuir qui est né avec le désir de recevoir, grâce à l'étreinte de ses accoudoirs inclinés et exaltés par la naturalité du nubuck et la stylisation raffinée de la couture à coupure vive.

A trois places avec une péninsule terminal, c'est un canapé qui se distingue par ses lignes douces et enveloppantes, dans lesquelles vous pouvez vous réfugier si vous êtes à la recherche d'une parenthèse de pure détente.







— Mod. Diva  
Versione 304  
Divano 4 posti in pelle  
con bordo a contrasto.







Home



— Mod. Diva  
Versioni 310 - 6341 - 600  
Salotto angolare in pelle  
con bordino in tinta.





## Diva



### — Rivestimento

Pelle / Tessuto

### — Imbottitura

BRACCIOLI / Poliuretano espanso  
SEDUTA / Poliuretano espanso - Piuma  
SPALLIERA / Piuma

— **Opzioni** Cucitura a contrasto

— **Comfort** Standard

— **Piedi** Plastica

— **Struttura** Telaio in legno

### — Coverings

Leather / Fabric

### — Filling

ARMS / Foam  
SEAT CUSHION / Foam - Feather  
BACK CUSHION / Feather

— **Options** Contrast stitching

— **Comfort** Standard

— **Legs** Plastic

— **Structure** Wooden frame

### — Revêtement

Cuir / Tissu

### — Rembourrage

ACCOUDOIRS / Mousse  
ASSISE / Mousse - Plumes  
DOSSIER / Plumes

— **Options** Coutures contrastées

— **Comfort** Standard

— **Pieds** Plastique

— **Structure** Structure en bois

### — Revestimiento

Piel / Tela

### — Imbottitura

APOYABRAZOS / Poliuretano expandido  
SENTADA / Poliuretano expandido - Piuma  
RESPALDO / Piuma

— **Opciones** Costura en contraste

— **Confort** Estándar

— **Pies** Plastico

— **Struttura** Estructura en madera

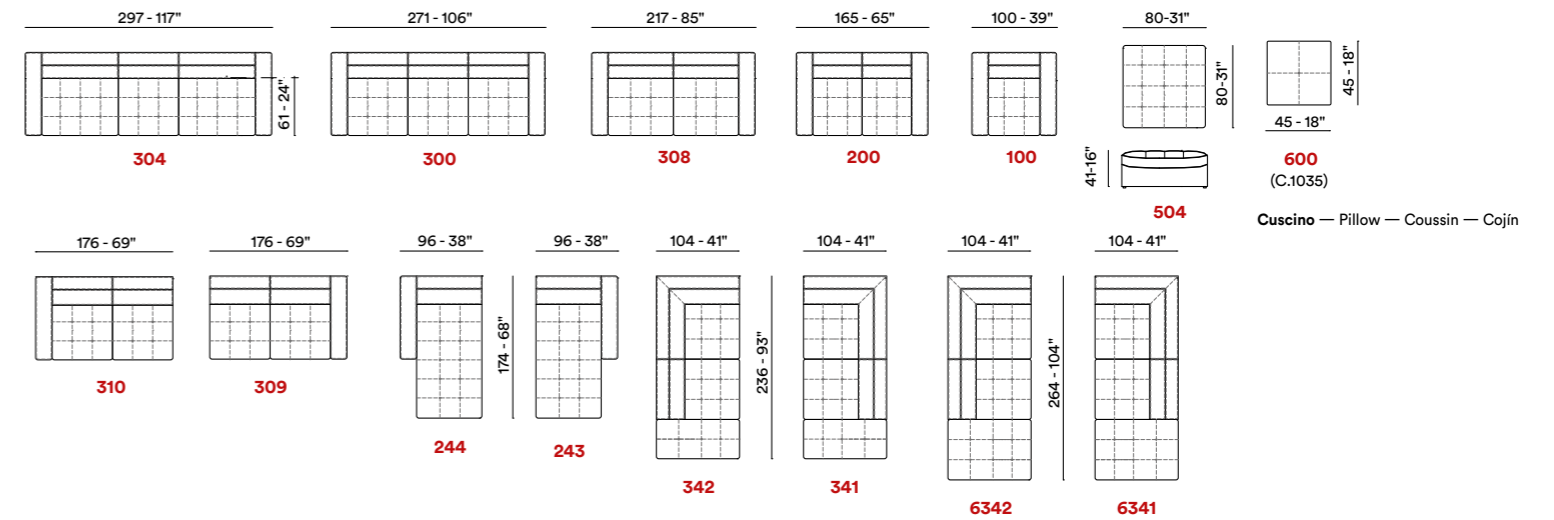

### Esempi di componibilità — Sectionals examples — Exemples de compositions — Ejemplos de modularidad

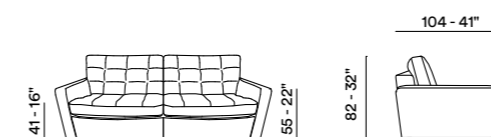
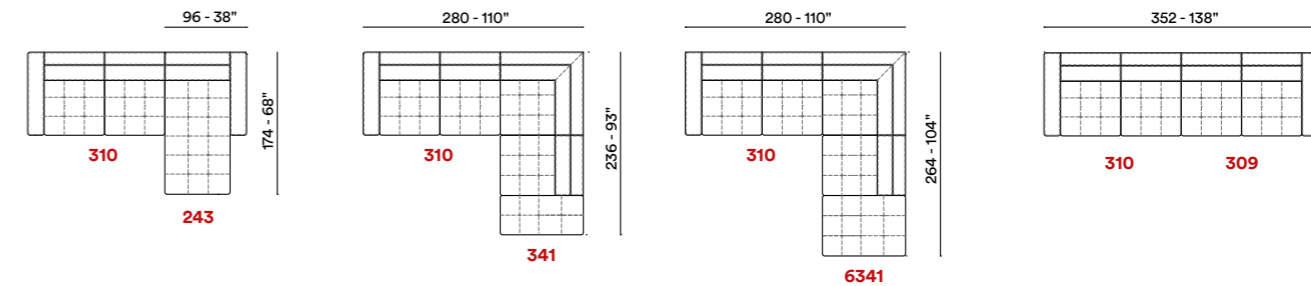



# Gran Torino

Innovazione e modernità — Innovation and modernity  
Innovation et modernité

ITA — Il concetto classico di salotto Italiano viene innovato con modernità in Gran Torino, il divano rivestito in tessuto o pelle, eccellenza del Made in Italy.

Gran Torino si caratterizza per una spalliera finemente trapuntata, sostenuta da piedi in metallo. Ai braccioli che seguono le forme dettate dal design del modello, si aggiungono dei cuscini che regalano possibilità di personalizzazione non solo allo stile ma anche al comfort.

ENG — The classic concept of the Italian living room has been modernised with Gran Torino, a fabric or leather upholstered Made in Italy sofa.

Gran Torino sofa is defined by an elegantly quilted backrest that is supported by metal legs. The armrests match the characteristic shapes of this model and you can add cushions to them in order to personalize the sofa not only for style, but also for comfort.

FR — Le concept classique du salon italien se voit renouvelé avec modernité chez Gran Torino, le canapé revêtu en tissu ou en cuir, l'excellence du Made in Italy.

Gran Torino se caractérise par un dossier finement piqué, soutenu par des pieds en métal. Les bras qui suivent les formes dictées par le design du modèle, s'ajoutent des coussins offrant des possibilités de personnalisation non seulement au style mais également au confort.







— Mod. Gran Torino  
Versioni 308 - 606 - 606  
Divano 3 posti in pelle.

Versione 100  
Poltrona in velluto.









— Mod. **Gran Torino**  
Versioni 308 - 606 - 606  
Divano 3 posti in pelle  
con cuscini cilindrici.





## Gran Torino



### — Rivestimento

Pelle / Tessuto

### — Imbottitura

BRACCIOLI / Poliuretano espanso

SEDUTA / Poliuretano espanso

SPALLIERA / Poliuretano espanso

— **Opzioni** Cucitura a contrasto

— **Comfort** Standard

— **Piedi** Metallo

— **Struttura** Telaio in legno

### — Coverings

Leather / Fabric

### — Filling

ARMS / Foam

SEAT CUSHION / Foam

BACK CUSHION / Foam

— **Options** Contrast stitching

— **Comfort** Standard

— **Legs** Metal

— **Structure** Wooden frame

### — Revêtement

Cuir / Tissu

### — Rembourrage

ACCOUDOIRS / Mousse

ASSISE / Mousse

DOSSIER / Mousse

— **Options** Coutures contrastées

— **Confort** Standard

— **Pieds** Metal

— **Structure** Structure en bois

### — Revestimiento

Piel / Tela

### — Imbottitura

APOYABRAZOS / Poliuretano expandido

SENTADA / Poliuretano expandido

RESPALDO / Poliuretano expandido

— **Opciones** Costura en contraste

— **Confort** Estándar

— **Pies** Metal

— **Struttura** Estructura en madera

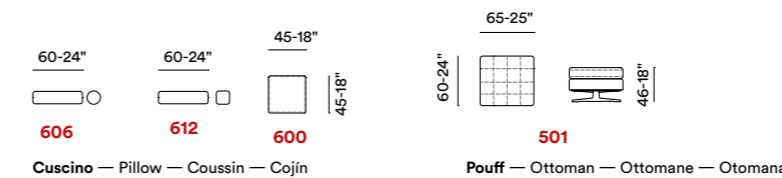
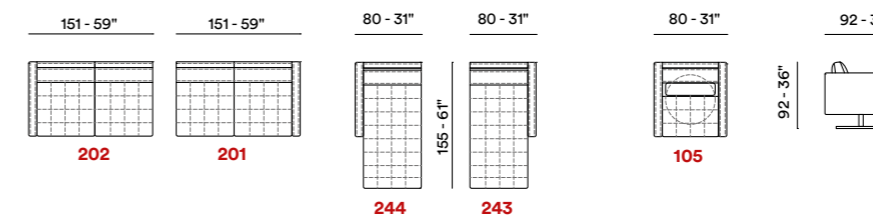
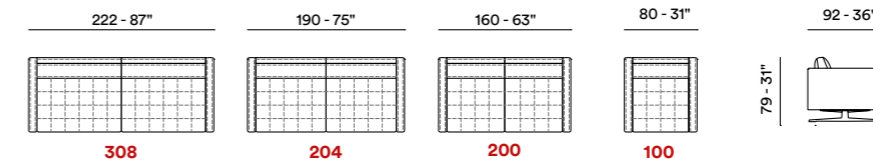

Esempi di componibilità — Sectionals examples — Exemples de compositions — Ejemplos de modularidad

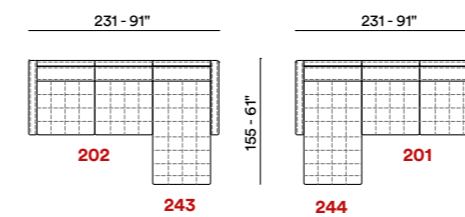

Finitura piedi — Legs finishes — Finition de pieds — Acabados de pies

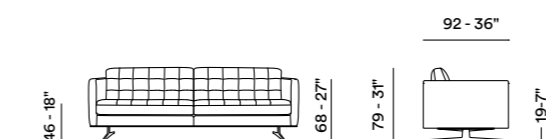



# Ida

Design pulito e particolare — Clean and special design  
Design propre et spécial

ITA — Ida è una creazione dal design pulito e al tempo stesso particolare, con braccioli, seduta e spalliera imbottiti con un'equilibrata calibratura del poliuretano espanso.

Un divano in pelle pura anilina con cuciture a taglio vivo che riscaldano l'ambiente, assolvendo una missione di comodità e stile senza paragoni, grazie alla qualità dei materiali e al design solido.

ENG — Ida is a clean-cut design, albeit peculiar with a balanced calibration of polyurethane foam the armrests, seating and backrest.

A sofa in aniline leather with visible seams that charm the environment, giving an unbeatable combination of comfort and style, thanks to the quality of its materials and perfect design.

FR — Ida est une création au design propre et à la fois particulier, avec accoudoirs, assise et dossier rembourrés, un calibrage équilibré de polyuréthane expansé.

Un divan en cuir nubuck avec coutures à coupe brute qui réchauffent le cadre, accomplissant une mission de confort et de style sans pareil, grâce à la qualité des matériaux et au design robuste.







— Mod. Ida  
Versioni 304 - 600 - 600  
Divano 4 posti in pelle pura anilina e cuscini.

Versioni 100  
Poltrona con braccioli stretti.





— Mod. **Ida**  
Versioni 100 - 600  
Poltrona in pelle pura anilina  
con braccioli stretti e cuscino.







## Ida



### — Rivestimento

Pelle / Tessuto

### — Imbottitura

BRACCIOLI / Poliuretano espanso

SEDUTA / Poliuretano espanso

SPALLIERA / Poliuretano espanso

— **Opzioni** Cucitura a contrasto

— **Comfort** Standard

— **Piedi** Plastica

— **Struttura** Telaio in legno

### — Coverings

Leather / Fabric

### — Filling

ARMS / Foam

SEAT CUSHION / Foam

BACK CUSHION / Foam

— **Options** Contrast stitching

— **Comfort** Standard

— **Legs** Plastic

— **Structure** Wooden frame

### — Revêtement

Cuir / Tissu

### — Rembourrage

ACCOUDOIRS / Mousse

ASSISE / Mousse

DOSSIER / Mousse

— **Options** Coutures contrastées

— **Comfort** Standard

— **Pieds** Plastique

— **Structure** Structure en bois

### — Revestimiento

Piel / Tela

### — Imbottitura

APOYABRAZOS / Poliuretano expandido

SENTADA / Poliuretano expandido

RESPALDO / Poliuretano expandido

— **Opciones** Costura en contraste

— **Comfort** Estándar

— **Pies** Plastico

— **Struttura** Estructura en madera

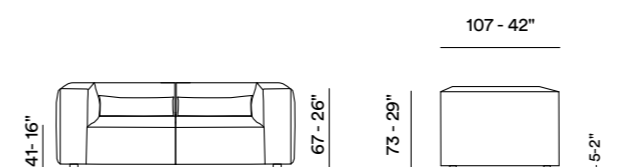
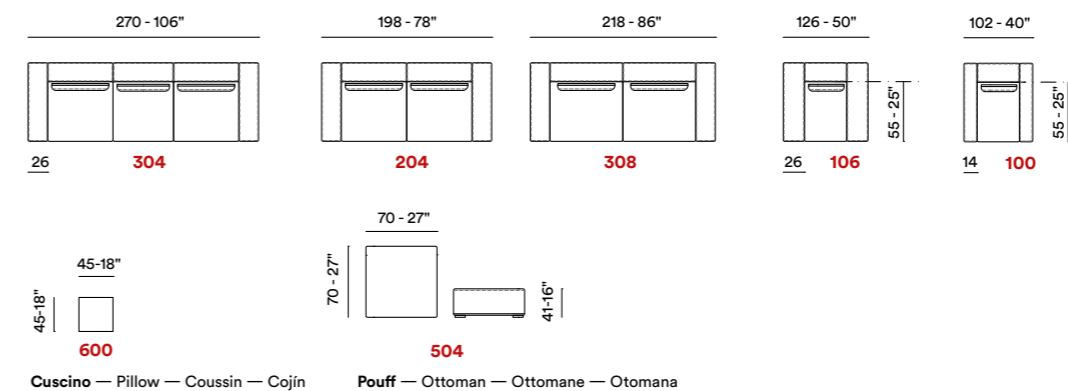



**Tradizionali  
con  
personalità**





# Blow

Design moderno ed elegante — Modern and elegant design  
Design moderne et élégant

ITA — Blow è il divano in tessuto Maxdivani dal design moderno ed elegante che combina sapientemente il comfort di un'ampia seduta angolare con spalliera in piuma d'oca con la praticità dei materiali sfoderabili, per non rinunciare a portare uno stile esclusivo nella vita di tutti i giorni.

Maxdivani Blow si rivela, così, un perfetto connubio di stile, eleganza e praticità, lasciando ampia espressione alla vostra creatività con le possibilità di combinazione di elementi e tessuti.

ENG — Blow is the MaxDivani fabric sofa with a contemporary and stylish design that combines the comfort of a large corner sofa with goose feather back cushions and the practical removable fabric covers, affording unique elegance for every day's lifestyle.

Maxdivani Blow sofa is a perfect blend of design, sophistication and comfort, providing lots of scope for your creativity with its endless possibilities, combining elements and fabrics.

FR — Blow est le canapé en tissu Maxdivani au design moderne et élégant qui combine le confort d'une grande assise d'angle avec un dossier en plume d'oie avec la commodité d'un matériau amovible, pour ne pas renoncer à apporter un style unique dans la vie de tous jours.

Maxdivani Blow se révèle ainsi être un mélange parfait de style, d'élégance et d'aspect pratique, laissant libre cours à votre créativité avec les possibilités de combinaison d'éléments et de tissus.







— Mod. Blow  
Versioni 114 - 125 - 407 - 125 - 520  
Salotto angolare a moduli singoli in tessuto sfoderabile.









# Blow



— **Rivestimento**

Tessuto sfoderabile

— **Imbottitura**

BRACCIOLI / Poliuretano espanso  
 SEDUTA / Poliuretano espanso - Piuma  
 SPALLIERA / Piuma

— **Opzioni** Cucitura a contrasto

— **Comfort** Standard

— **Piedi** Plastica

— **Struttura** Telaio in legno

— **Coverings**

Fabric removable

— **Filling**

ARMS / Foam  
 SEAT CUSHION / Foam - Feather  
 BACK CUSHION / Feather

— **Options** Contrast stitching

— **Comfort** Standard

— **Legs** Plastic

— **Structure** Wooden frame

— **Revêtement**

Tissu déhoussable

— **Rembourrage**

ACCOUDOIRS / Mousse  
 ASSISE / Mousse - Plumes  
 DOSSIER / Plumes

— **Options** Coutures contrastées

— **Confort** Standard

— **Pieds** Plastique

— **Structure** Structure en bois

— **Revestimiento**

Tela extraíble

— **Imbottitura**

APOYABRAZOS / Poliuretano expandido  
 SENTADA / Poliuretano expandido - Piuma  
 RESPALDO / Piuma

— **Opciones** Costura en contraste

— **Confort** Estándar

— **Pies** Plástico

— **Struttura** Estructura en madera

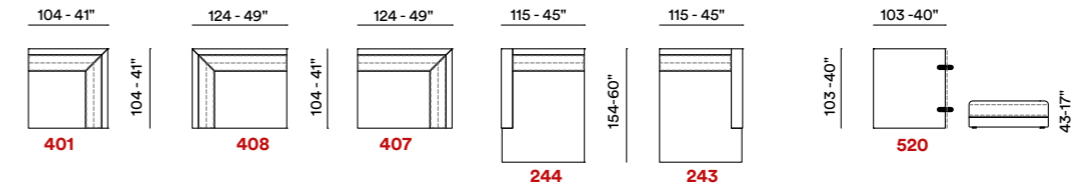

Esempi di componibilità — Sectionals examples — Exemples de compositions — Ejemplos de modularidad

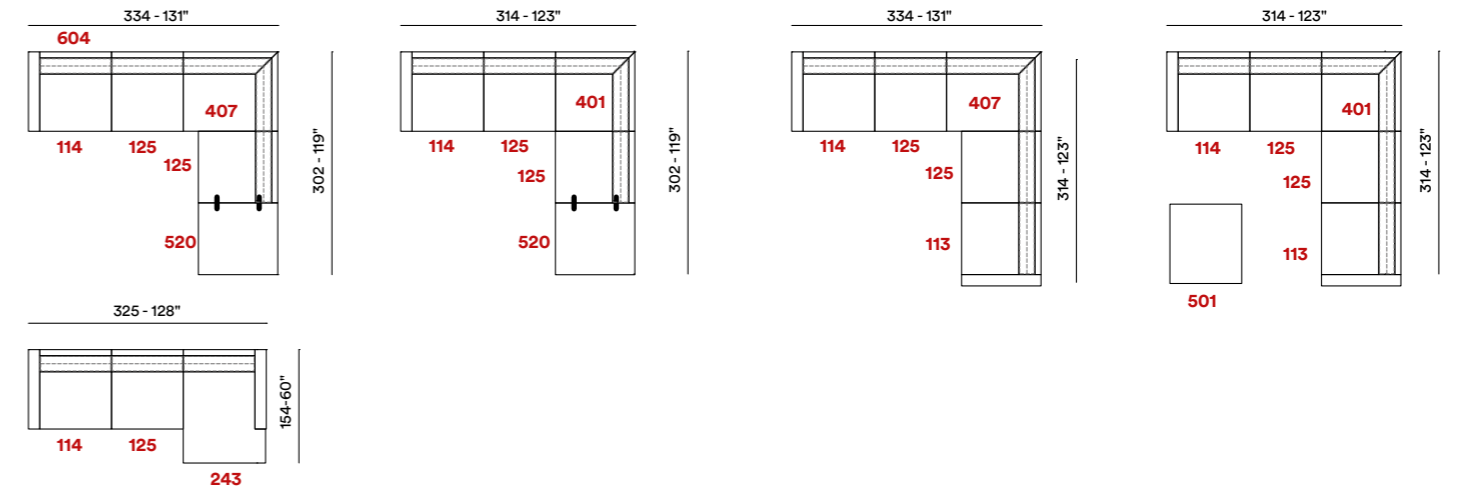

— **Modello brevettato** — Patented model

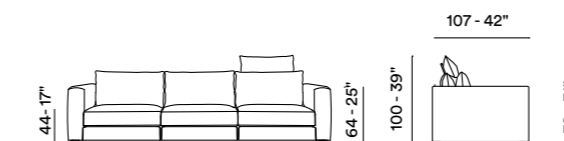



# Amico

---

Adatto ai grandi spazi — Suitable for large spaces  
Convient aux grands espaces

ITA — Amico è il divano artigianale destinato ad abitare grandi spazi con il suo design squadrato e contemporaneo.

Il divano Made in Italy Amico, solido ed imponente, esprime il massimo di sé nel rivestimento in pelle marrone dalla caratteristica lavorazione nuvolata che gli conferisce un aspetto “vintage” leggermente sfumato.

ENG — Amico is a handcrafted sofa destined to fill large spaces with its modern design.

The stunning Amico sofa gives its best in a brown leather covering with the characteristic buffed treatment, giving it a vintage and slightly faded look.

FR — Amico est le canapé artisanal destiné à occuper de grands espaces avec son design carré et contemporain.

Ce canapé Made in Italy, solide et imposant, exprime le meilleur de lui-même dans son revêtement en cuir marron avec traitement nuageux qui lui donne un aspect « vintage » légèrement trouble.







— Mod. Amico  
Versioni 114 - 125 - 113  
Divano 4 posti a moduli singoli in pelle.  
Cuscini cod. C1033





— Mod. Amico  
Versioni 114 - 125 - 401 - 125 - 125 - 245  
Salotto angolare con chaise longue  
a moduli singoli in tessuto.





— Mod. **Amico**  
Versioni 114 - 125 - 113  
Divano 4 posti a moduli  
singoli in pelle.  
Cuscini cod. C1033.

## Comfort assicurato

Comfort is guaranteed — Le confort est assuré

ITA — Il comfort è assicurato non solo dall'imbottitura in poliuretano espanso accuratamente calibrata a differenti densità, ma anche dalle forme, con uno schienale basso combinato con un ampio bracciolo a completare la comoda seduta.

ENG — Comfort is guaranteed not only by its accurately calibrated in different densities polyurethane upholstery, but also by its shape, with a lower backrest and wide armrests to complete the comfortable seating.

FR — Le confort est assuré autant par le rembourrage en polyuréthane expansé soigneusement calibré dans différentes densités, mais aussi par les formes, combinées avec un dossier bas couplé à un grand accoudoir pour compléter une assise confortable.





# Amico



— **Rivestimento**

Pelle / Tessuto

— **Imbottitura**

BRACCIOLI / Poliuretano espanso

SEDUTA / Poliuretano espanso

SPALLIERA / Poliuretano espanso

— **Opzioni** Cucitura a contrasto

— **Comfort** Standard

— **Piedi** Plastica

— **Struttura** Telaio in legno

— **Coverings**

Leather / Fabric

— **Filling**

ARMS / Foam

SEAT CUSHION / Foam

BACK CUSHION / Foam

— **Options** Contrast stitching

— **Comfort** Standard

— **Legs** Plastic

— **Structure** Wooden frame

— **Revêtement**

Cuir / Tissu

— **Rembourrage**

ACCOUDOIRS / Mousse

ASSISE / Mousse

DOSSIER / Mousse

— **Options** Coutures contrastées

— **Comfort** Standard

— **Pieds** Plastique

— **Structure** Structure en bois

— **Revestimiento**

Piel / Tela

— **Imbottitura**

APOYABRAZOS / Poliuretano expandido

SENTADA / Poliuretano expandido

RESPALDO / Poliuretano expandido

— **Opciones** Costura en contraste

— **Comfort** Estándar

— **Pies** Plastico

— **Struttura** Estructura en madera

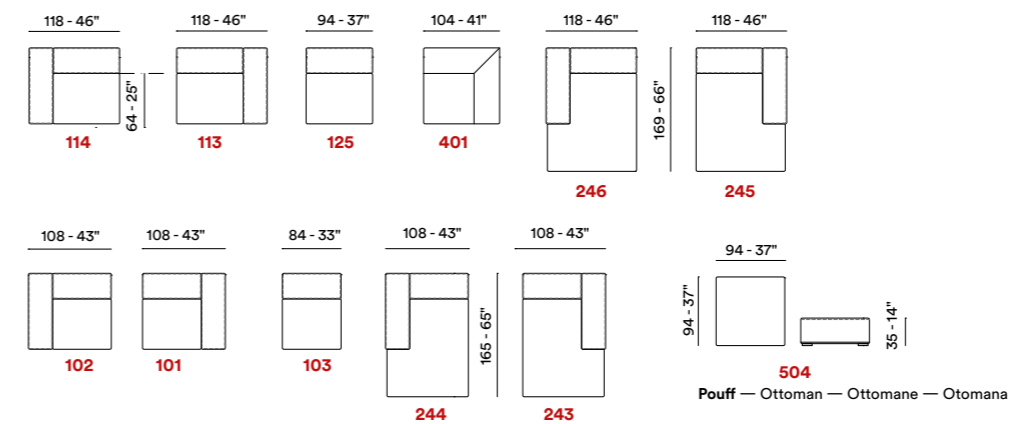

Esempi di componibilità — Sectionals examples — Exemples de compositions — Ejemplos de modularidad

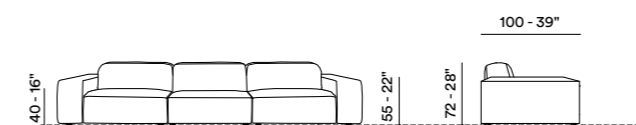
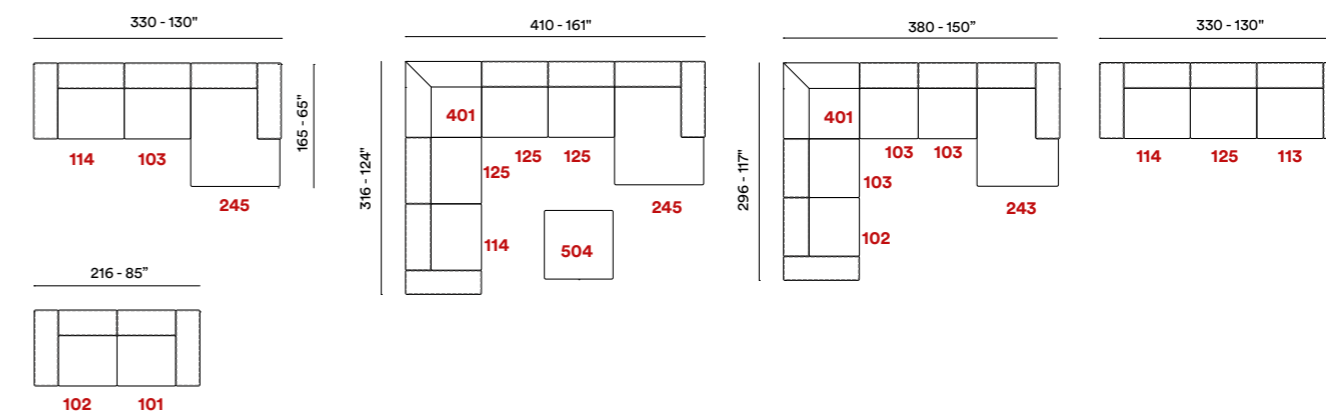



A close-up photograph of a vintage sewing machine's needle and foot assembly. The metal parts are heavily rusted and show signs of age. A thin, white spiderweb is draped across the left side of the frame. The background is dark and out of focus, showing a wooden surface.

**La tradizione  
che resiste**



# Technical Info

## Abaco

→ 161

## Finiture

Finishings — Finition — Acabados

→ 166

## Descrizione struttura

Internal structure description — Description structure

— Estructura estructura

→ 167

## Albachiara

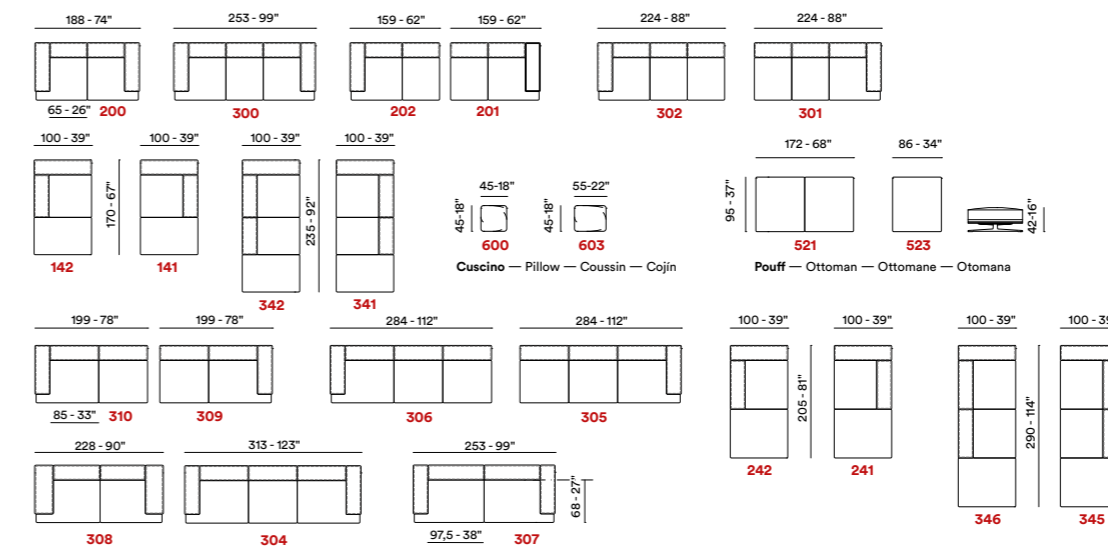

## Amico

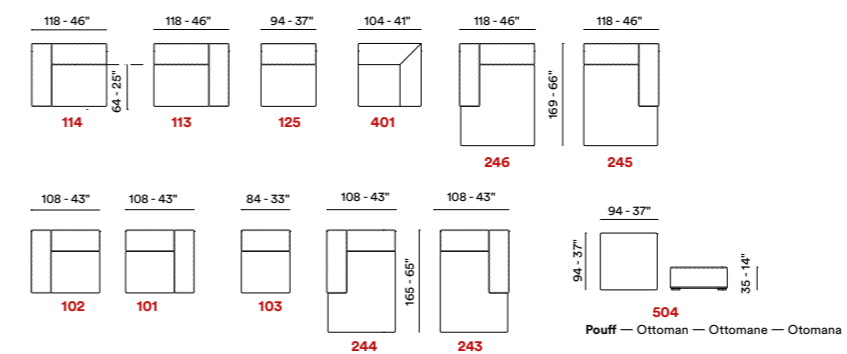



## Autografo

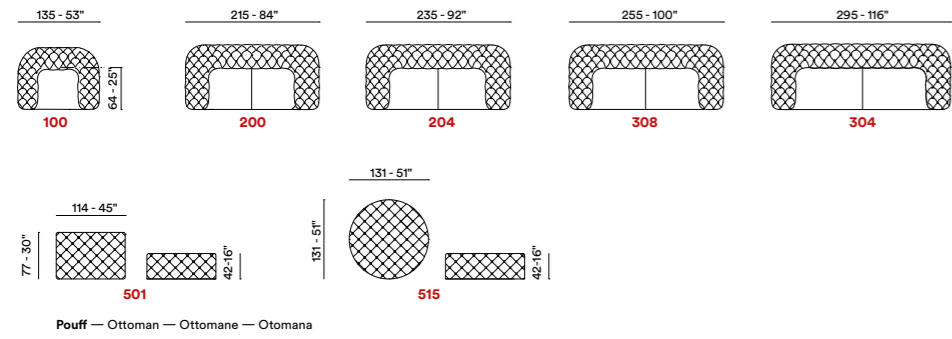

## Blow

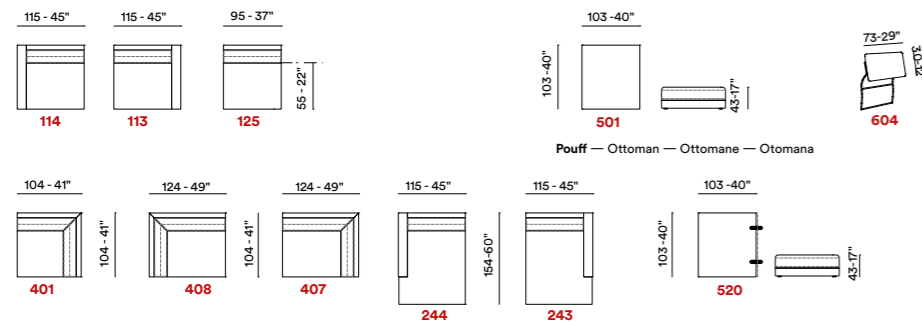

## Diva

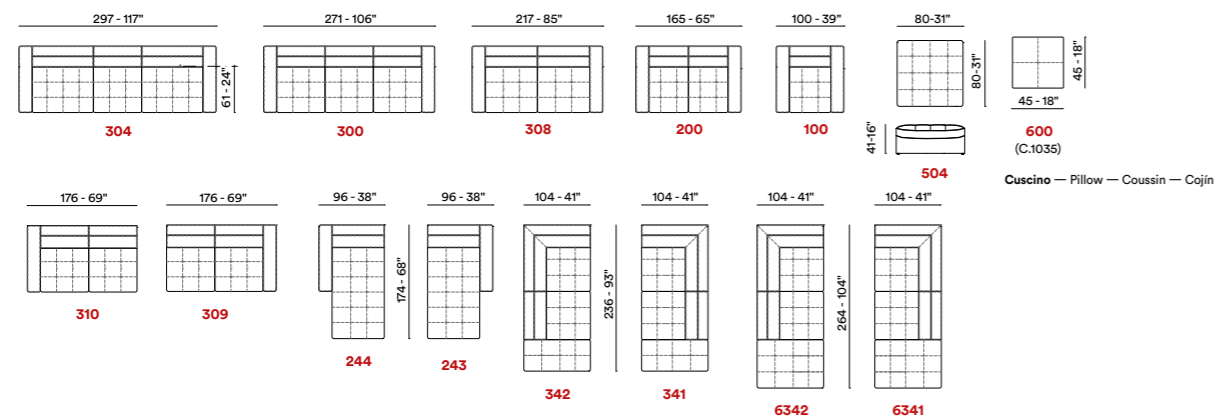

## Ever

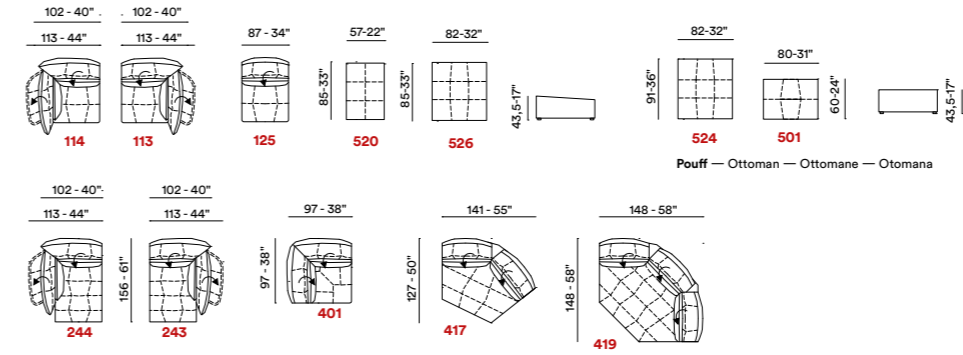

## Grace

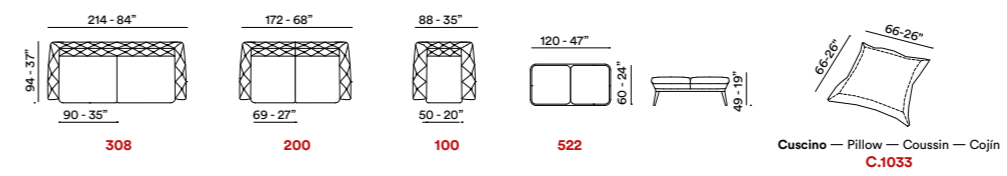

## Gran Torino

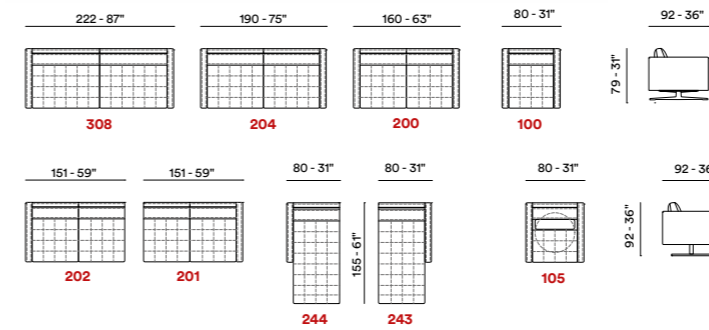



## Groove

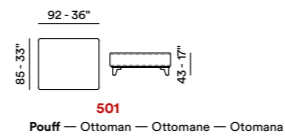
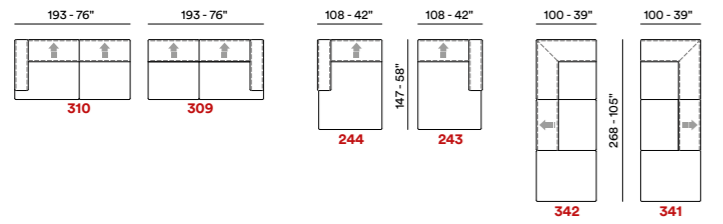
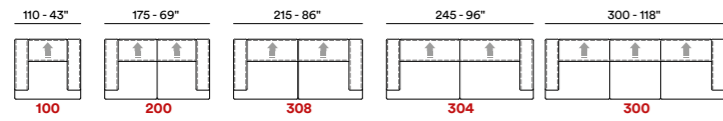

Pouff — Ottoman — Ottomane — Otomana



Only for versions 100 - 200



## Ida

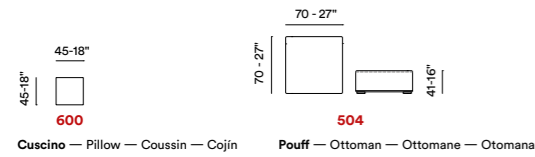
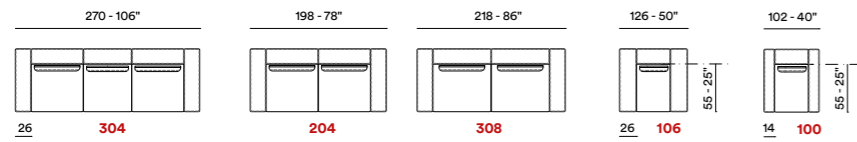

Cuscino — Pillow — Coussin — Cojín    Pouff — Ottoman — Ottomane — Otomana

## Ingrid

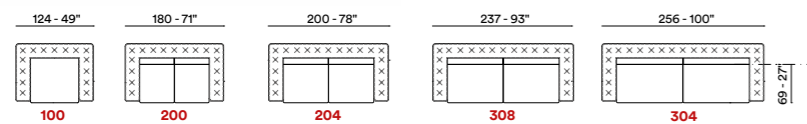

Cuscino — Pillow — Coussin — Cojín

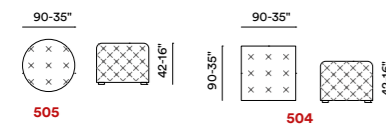

Pouff — Ottoman — Ottomane — Otomana

## Nando

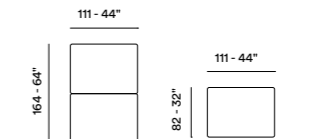
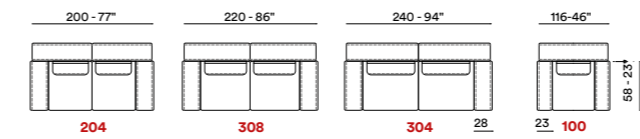

Pouff — Ottoman — Ottomane — Otomana

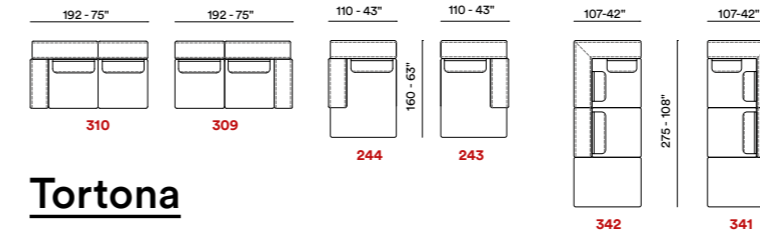

## Tortona

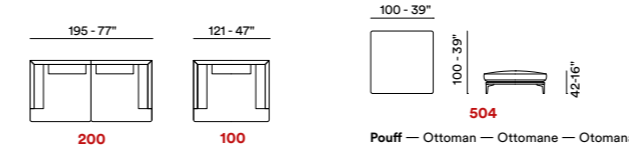
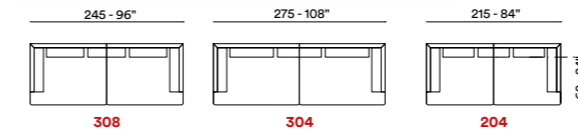

Pouff — Ottoman — Ottomane — Otomana

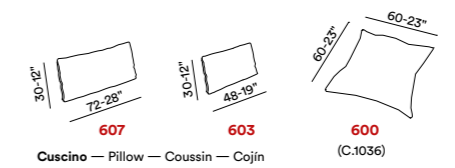

Cuscino — Pillow — Coussin — Cojín

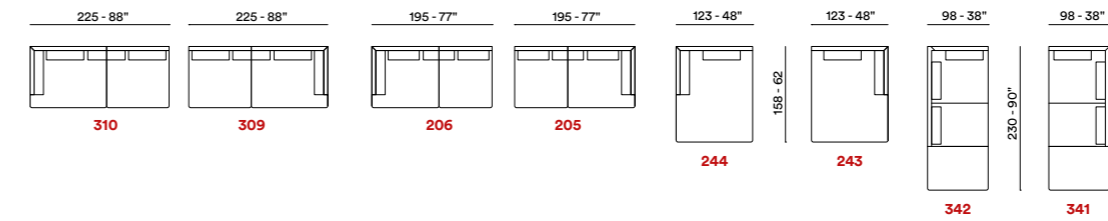



## Finiture

Finishings — Finition — Acabados

Piedi — Legs — Pieds — Pies

Metallo — Metal — Metal — Metal



**10**  
**Lucido**  
Chrome  
Brillant  
Brillante



**11**  
**Satinato**  
Brushed  
Mat  
Satinado

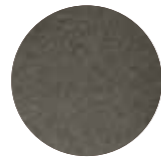

**22**  
**Bronzato**  
Bronze  
Bronce

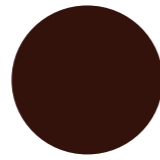

**26**  
**Marrone**  
Dark brown  
Marron



**37**  
**Mastice**  
Darke taupe  
Bronze  
Masilla



**41**  
**Ferro calamina**  
Calamine iron  
Fer calamine  
Hierro calamina

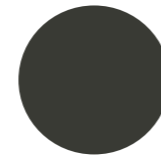

**42**  
**Grigio scuro**  
Dark grey  
Gris foncé  
Gris oscuro

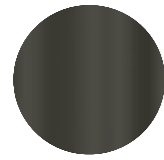

**46**  
**Titanio**  
Titanium  
Titane  
Titanio

Legno — Wood — Bois — Madera



**01**  
**Naturale**  
Natural  
Naturel  
Naturales



**02**  
**Ciliegio**  
Cherry  
Merisier  
Cerezo

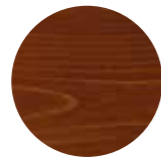

**03**  
**Noce**  
Walnut  
Noyer  
Nuez



**04**  
**Noce brunito**  
Dark walnut  
Noyer foncé  
Nogal dorado

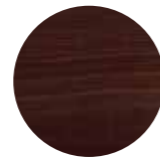

**06**  
**Wengè**  
Wengè  
Wengè  
Wengè



**09**  
**Alluminio**  
Aluminium  
Aluminium  
Aluminio



**12**  
**Sbiancato**  
White washed  
Céruse  
Blanqueado

Tavolini — Tables — Table — Tablas

Ripiano — Table top — Table — Tablas



**90**  
**Marmo marrone**  
Brown marble  
Marbre brun  
Mármol marrón



**91**  
**Marmo bianco**  
White marble  
Marbre blanc  
Mármol blanco



**18**  
**Noce canaletto**  
Canaletto walnut  
Bois noyer canaletto  
Madera de nogal

Struttura — Frame — Structure — Estructura



**10**  
**Lucido**  
Chrome  
Brillant  
Brillante

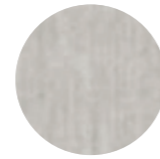

**11**  
**Satinato**  
Brushed  
Mat  
Satinado



**41**  
**Ferro calamina**  
Calamine iron  
Fer calamine  
Hierro calamina

— I riferimenti dei colori qui riportati sono da considerarsi puramente indicativi.  
— Color reference shown is only indicative.  
— La référence coloris mentionnée est purement indicative.  
— Las referencias de color que se muestran aquí deben considerarse puramente indicativas.

## Descrizione struttura

Internal structure description — Description structure — Escriptcion estructura



### ITA — Struttura in legno

La struttura portante è realizzata in legno massello di abete a vari spessori. Per le parti non strutturali si utilizzano pannelli di particelle di legno e pannelli di fibra di legno fini e uniformi legate con resine.

### Struttura in legno e metallo

La struttura portante è realizzata in legno massello e profili di metallo a differenti sezioni. Per le parti non strutturali si utilizzano pannelli di particelle di legno e pannelli di fibra di legno fini e uniformi legate con resine.

### Struttura in metallo

La struttura portante è realizzata con telaio in ferro a differenti sezioni. Per le parti non strutturali e di tamponamento si utilizzano reti elettrosaldate a differenti maglie.

### ENG — Wooden structure

The supporting structure is made of solid fir wood of various thicknesses, for the non-structural parts are used panels of wood's particles and also fine and uniform wood fiber panels bonded with resins.

### Wood and metal structure

The supporting structure is made of solid wood and metal profiles with different sections, for the non-structural parts are used panels of wood's particles and also fine and uniform wood fiber panels bonded with resins.

### Metal structure

The supporting structure is made of an iron frame with different sections, for the non-structural parts and infill parts are used electrowelded with different meshes.

### FR — Structure en bois

La structure de support est faite de bois de sapin massif de diverses épaisseurs. Pour les parties non structurelles on utilise des panneaux de particules de bois et des panneaux de fibres de bois fins et uniformes liés avec des résines.

### Bois et structure métallique

La structure de support est composée de profilés en bois massif et en métal avec différentes sections. Pour les parties non structurelles on utilise des panneaux de particules de bois et des panneaux de fibres de bois fins et uniformes collés avec des résines.

### Structure métallique

La structure de support est faite d'un cadre de fer avec différentes sections. Pour les parties non structurelles et de remplissage on utilise des mailles électrosoudées.

### ES — Estructura de madera

La estructura de soporte está hecha de madera de abeto macizo de varios espesores, para las partes no estructurales se utilizan paneles de partículas de madera y paneles de fibra de madera finos y uniformes unidos con resinas.

### Estructura de madera y metal

La estructura de soporte está hecha de madera maciza y perfiles metálicos con diferentes secciones, para las partes no estructurales se utilizan paneles de partículas de madera y paneles de fibra de madera finos y uniformes unidos con resinas.

### Estructura de metal

La estructura de soporte está hecha de un marco de hierro con diferentes secciones, para las partes no estructurales y de relleno se utilizan mallas electrosoldadas con diferentes mallas.



**Maxdivani S.r.l.**

Largo Epitaffio, 1  
70022 Altamura (Ba)  
Tel. +39 080 926 6200  
info@maxdivani.it  
maxdivani.it

**Art Direction**

—

Arch. Giuseppe Logrieco / Maxdivani mktg. dept.

**Graphic Design**

—

Leonardi and Partners

**Photo**

—

Leon Foto / Stragapede

**Color Selections**

—

Color Lab

**Print**

—

Stampa Sud S.p.A.

Stampato in Italia - Marzo 2020

Printed in Italy - March 2020

La MAXDIVANI s.r.l. si riserva la facoltà di modificare in qualunque momento e senza preavviso, le caratteristiche tecniche degli elementi usati nel presente catalogo. Le misure riportate nei grafici possono subire variazioni dovute alla manifattura. Alcuni accessori presenti nelle immagini fotografiche non sono prodotti dalla MAXDIVANI s.r.l.. Il presente catalogo è tutelato dalla legge sui diritti d'Autore (legge 22.4.1941, n° 633 e della legge 14.12.1942, n° 1485); e successive modifiche, di esso è proibita ogni riproduzione, totale o anche parziale in Italia o all'estero.

MAXDIVANI s.r.l. reserves the right to modify in any moment and without notice the technical characteristics of the elements used in this catalogue. Some dimensions reported in the schematics may be subject to modifications due to manufacturing. Some of the accessories shown in the pictures are not produced by MAXDIVANI s.r.l.. This catalogue is protected by the law on Author's Rights (law dated 22.04.1941, no. 633 and by the law dated 14.12.1942, no. 1485); and its following modifications. Any reproduction, complete or in part, is forbidden in Italy and abroad.

MAXDIVANI s.r.l. se réserve le droit de modifier à tout moment et sans préavis les caractéristiques techniques des éléments utilisés dans ce catalogue. Les mesures montrées dans les graphiques peuvent subir des variations dues à la fabrication. Certains accessoires présents dans les images photographiques ne sont pas produits par MAXDIVANI srl Ce catalogue est protégé par la loi sur les droits d'auteur (loi 22.4.1941, loi n° 633 et loi 14.12.1942, n° 1485); telle que modifiée, Il est interdit toute reproduction, totale ou même partielle en Italie ou à l'étranger.

El MAXDIVANI s.r.l. se reserva el derecho de modificar en cualquier momento y sin previo aviso las características técnicas de los elementos utilizados en este catálogo. Las medidas que se muestran en los gráficos pueden sufrir variaciones debido a la fabricación. Algunos accesorios presentes en las imágenes fotográficas no son producidos por MAXDIVANI s.r.l. Este catálogo está protegido por la ley de derechos de autor (ley 22.4.1941, n° 633 y ley 14.12.1942, n° 1485); está prohibido cualquier reproducción, total o parcial en Italia o en el extranjero.





**maxdivani.it**



Maxdivani s.r.l. - Largo Epitaffio, 1 - 70022 Altamura (Ba) Italy - Tel +39 080 9266200 - info@maxdivani.it