

Vol. 2
Sofas Collection



 **maxdivani**

Vol. 2
Sofas Collection

 maxdivani

 maxdivani

 maxdivani

 maxdivani



Una storia solida ed elegante

A solid and elegant history — Une histoire solide et élégante, comme ses canapés

ITA — MaxDivani disegna e realizza Divani Italiani da oltre 60 anni. La nostra storia svela la raffinata cura alla base dei nostri Divani Artigianali.

ENG — MaxDivani has designed and created 100% Italian sofas for over 60 years. Our heritage shows the refined care we put into our handcrafted sofas.

FR — MaxDivani conçoit et réalise des canapés italiens depuis plus de 60 ans. Notre histoire révèle le soin raffiné avec lequel sont fabriqués nos canapés artisanaux.



ITA — La nostra storia comincia oltre mezzo secolo fa, ad Altamura, in quello che, grazie alla passione e all'operosità dei suoi lavoratori, è riconosciuto come il distretto del mobile imbottito murgiano.

ENG — Our history began over half a century ago in Altamura, a place that, thanks to its workers' passion and toil, has been recognised as being the upholstered furniture district of Murgia.

FR — Notre histoire commence il y a plus d'un demi-siècle à Altamura, dans ce qu'on appelle, grâce à la passion et au travail constant de ses travailleurs, le district des canapés et fauteuils de Murgia.

Qui, nel 1956, il suo fondatore, Rocco Ferri, ha dato vita a MaxDivani, l'azienda che in poco tempo si è affermata per la qualità superiore espressa dai suoi divani artigianali.

It was here in 1956 that the founder, Rocco Ferri, began MaxDivani, a company that affirmed itself immediately for its higher quality handcrafted sofas.

C'est ici qu'en 1956, son fondateur Rocco Ferri a donné vie à MaxDivani, l'entreprise qui, en très peu de temps, s'est imposée pour la qualité supérieure de ses canapés artisanaux.



100% Made in Italy

100% Italian sofas — Canapés 100 % Italiens

ENG — The handcrafted MaxDivani sofas are completely created in Italy. Discover the unique comfort of the 100% Italian sofas.

FR — Es Canapés Artisanaux Maxdivani sont entièrement fabriqués en Italie. Découvrez le confort unique des canapés 100 % Italiens.

ITA — I Divani Artigianali di MaxDivani sono completamente realizzati in Italia. Scopri il Comfort unico dei Divani Italiani al 100%.



ITA — Una staffetta dritta al traguardo dell'eccellenza.
I divani Made in Italy MaxDivani sono il risultato di un appassionato passaggio di testimone tra designer, progettisti, falegnami, fabbri e tappezzieri. Ogni protagonista mette in gioco tutte le sue potenzialità creative e operative per dar vita ad un prodotto curato e testato per essere resistente e confortevole, piacevole e definito, rispettoso della lezione della tradizione, con lo sguardo rivolto al futuro.

ENG — A race which arrives right to the finish line of excellence.

The Made in Italy sofas by Maxdivani are the result of a passionate passing of the baton between designers, engineers, carpenters, blacksmiths and upholsterers. Each person plays a significant role, putting all their creative and operational potential into the company to create a product which has been thoroughly tested to be durable and comfortable, enjoyable and defined, following the tradition but gazing towards the future.

FR — Un relais directement à l'étape de l'excellence.

Les canapés Made in Italy Maxdivani sont le résultat d'un passage passionné de témoin entre les concepteurs, les ingénieurs, les charpentiers, les forgerons et les tapissiers. Chaque protagoniste met en jeu tout son potentiel créatif et opérationnel pour créer un produit soigné et testé pour être durable et confortable, agréable et défini, respectueux de la tradition tout en ayant un œil vers l'avenir.

Tutto il valore di casa nostra per dare valore a casa tua

The value of our home to give value to yours
— Toute la valeur de notre maison pour donner de la valeur à votre maison

ITA — L'idea progettuale continua a correre trasportata all'esperienza dei maestri falegnami, a cui è affidata la realizzazione del fusto in legno. Allo scheletro portante dei nostri divani artigianali, assemblati a mano, viene aggiunta una morbida anima modellata sulle forme del singolo esemplare e bilanciata tra poliuretano espanso e piume d'oca, per assicurare il massimo comfort.



ENG — The project continues to pass into the experience of the master carpenters who are entrusted with the creation of the wooden framing.

The supporting skeleton of our handmade sofas are assembled by hand, consequently a soft core is modelled into the single specimen models, creating a balance between polyurethane foam and goose-feather filling to ensure maximum comfort.

FR — L'idée du projet continue d'avancer, transportée vers l'expérience des maîtres charpentiers, à qui est confiée la réalisation du cadre en bois.

Au squelette porteur de nos canapés artisanaux, assemblés à la main, s'ajoute une âme souple modelée sur les formes du prototype et équilibrée entre la mousse de polyuréthane et les plumes d'oie, pour assurer un maximum de confort.



Index

Divani
Sofas
Canapé
Sofás



Bogart

→ 012



Quadro

→ 034



Tok

→ 050



Esprit

→ 068



Bebe

→ 084



Noa

→ 094



Cloud

→ 108



Kilt

→ 120



Riflesso

→ 128



Flam

→ 140



Asap

→ 150



Raffaello

→ 160

Poltrone
Armchairs
Fauteuils
Sillones



Regina

→ 170



Blenda

→ 174



Dalia

→ 178



Doroty

→ 182

Complementi

Accessories — Accessoires — Accesorios

→ 189

Tecnical Info

→ 198

An aerial, high-angle photograph of a city street intersection. The image is split vertically: the left side is in sharp focus, showing a tall building with a grid-like facade and a street with cars and a bus. The right side is faded and semi-transparent, showing a similar view from a different angle. The text 'Punti di vista' is overlaid on the right side in a large, bold, black serif font.

Punti di vista



Bogart

Ricchezza nei dettagli
Richness in details — Un canapé riche en détails

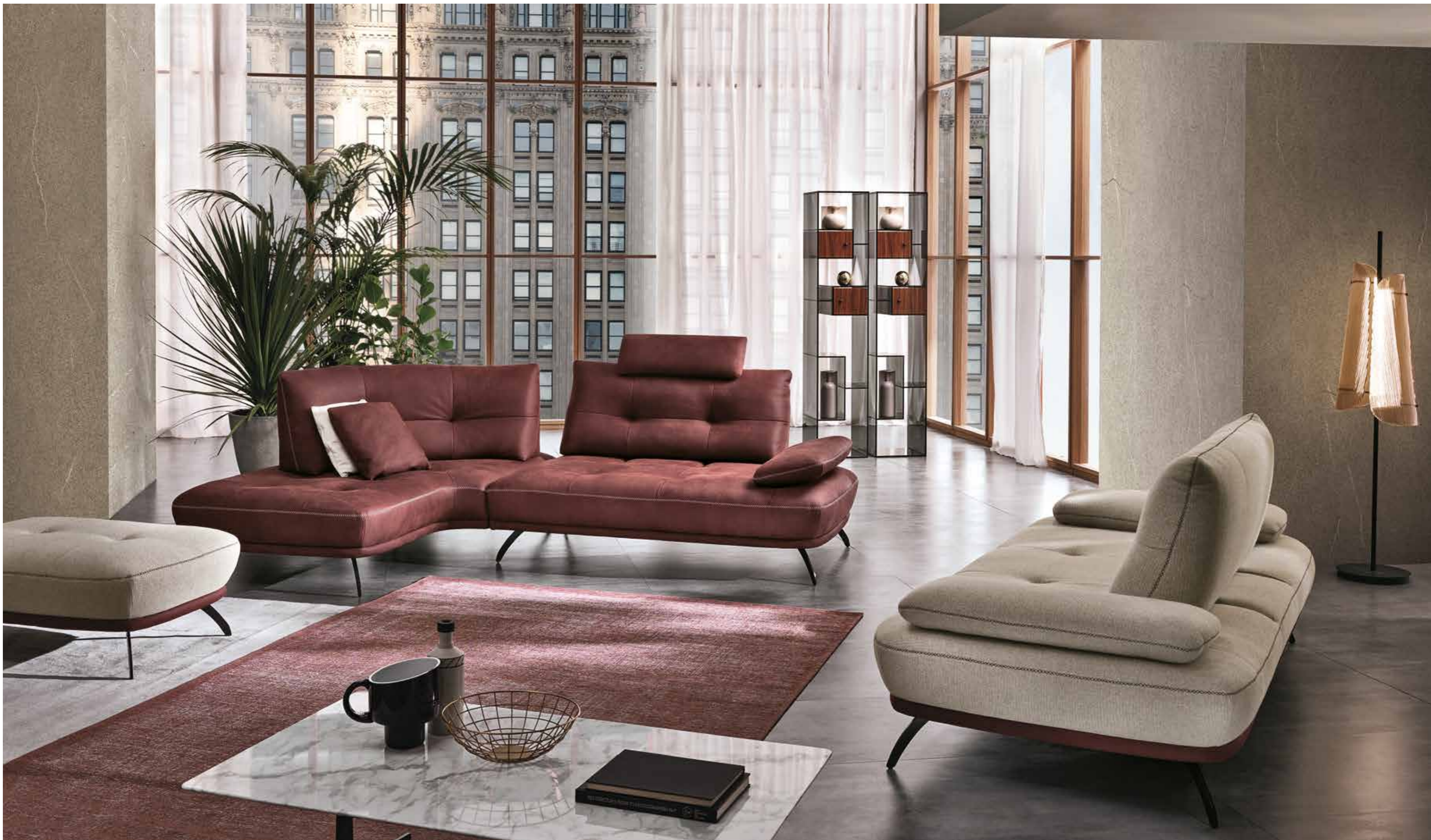





— Tavolino Mod.
Capri finitura 41/91.

— Mod. Bogart
Versioni 309 – 404 – 608 – 308
Salotto angolare in pelle
e divano 3 posti in pelle e tessuto.

Rifiniture particolari

Special details — Détails spéciaux

ITA — Ricco di dettagli dalla trapuntatura della seduta e della spalliera al doppio colore della base e peculiarità importante la rifinitura con cucitura speciale ad X che caratterizza tutto il modello.

ENG — Full of details from the quilting of the seats and backrest to the double - coloured base, an important feature is the special X - stitch finishing that characterises the entire model.

FR — La richesse des détails est visible dans le matelassage de l'assise et du dossier ainsi que dans la double couleur du piètement. Une particularité importante est la finition avec des coutures spéciales en forme de X, qui caractérise le modèle dans son ensemble.





Ricchezza nei dettagli

Richness in details — Un canapé riche en détails

— Mod. **Bogart**
Versioni 310 – 403
Salotto angolare
in pelle e tessuto.



ITA — Salotto angolare composto da un divano ad un bracciolo ed angolo terminale, molto caratterizzanti sono le spalliere con meccanismo avanti - dietro manuale che aumentano la profondità del salotto di 26 cm.



ENG — Corner lounge composed of a sofa with one armrest and a round terminal corner; back sliding system is a peculiarity of this product, increasing the depth of the sofa of about 26 cm.

FR — Salon d'angle composé d'un canapé avec un accoudoir et un angle terminal arrondi, avec un système avance - recule qui permet d'augmenter la profondeur d'assise de 26 cm.





— Mod. Bogart
Versioni 309 – 404
Salotto angolare in pelle.



Cambia il tuo concetto di divano

Change the Way you think about sofas
— Changez la manière dont vous vivez les canapés



ITA — Imbottitura in poliuretano espanso a differenti densità, disponibile in pelle e tessuto, particolare la finitura in ferro calamina del piede in metallo.

ENG — Polyurethane foam padding with different densities, available in leather and fabric, with a particular iron calamine finishing of the metal foot.

FR — Disponible en cuir et en tissu, avec capitonnage en polyuréthane expansé de différentes densités et pieds en métal avec finition spéciale en calamine.





— Mod. **Bogart**
Versioni 309 - 404
Salotto angolare in pelle.



— Mod. **Bogart**
Versioni 310 - 400 - 309
Salotto angolare in pelle.



Bogart



- | | | | |
|---|---|---|--|
| <p>— Rivestimento
Pelle / Tessuto</p> <p>— Imbottitura
BRACCIOLI / Poliuretano espanso
SEDUTA / Poliuretano espanso
SPALLIERA / Poliuretano espanso</p> <p>— Opzioni Cucitura a contrasto</p> <p>— Comfort Standard</p> <p>— Piedi Metallo</p> <p>— Struttura Telaio in ferro e legno</p> | <p>— Coverings
Leather / Fabric</p> <p>— Filling
ARMS / Foam
SEAT CUSHION / Foam
BACK CUSHION / Foam</p> <p>— Options Contrast stitching</p> <p>— Comfort Standard</p> <p>— Legs Metal</p> <p>— Structure Iron and wooden frame</p> | <p>— Revêtement
Cuir / Tissu</p> <p>— Rembourrage
ACCOUDOIRS / Mousse
ASSISE / Mousse
DOSSIER / Mousse</p> <p>— Options Coutures contrastées</p> <p>— Comfort Standard</p> <p>— Pieds Metal</p> <p>— Structure Structure en bois et fer</p> | <p>— Revestimiento
Piel / Tela</p> <p>— Imbottitura
APOYABRAZOS / Poliuretano expandido
SENTADA / Poliuretano expandido
RESPALDO / Poliuretano expandido</p> <p>— Opciones Costura en contraste</p> <p>— Confort Estándar</p> <p>— Pies Metal</p> <p>— Struttura Estructura en madera y hierro</p> |
|---|---|---|--|

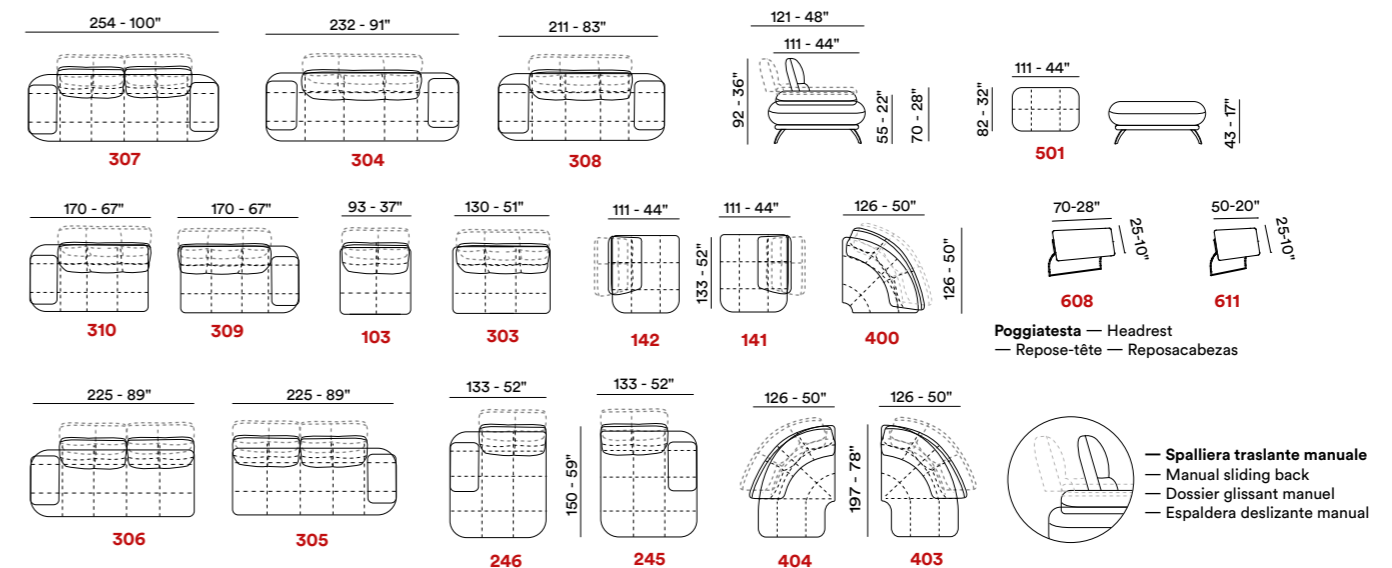

Esempi di componibilità — Sectionals examples — Exemples de compositions — Ejemplos de modularidad

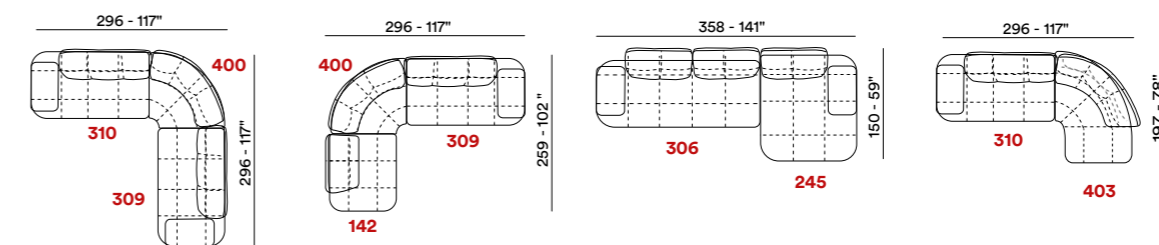

— **Modello brevettato** — Patented model

Finitura piedi — Legs finishes — Finition de pieds — Acabados de pies

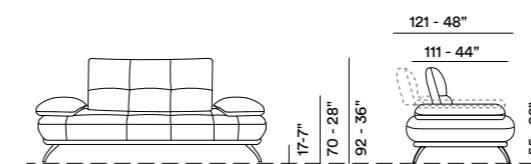

- | | | | | |
|---|--|--|---|---|
| | | | | |
| 11
Satinato
Brushed
Mat
Satinado | 26
Marrone
Dark brown
Marron
Marrón | 37
Mastice
Darke taupe
Mastic
Masilla | 41
Ferro calamina
Calamine iron
Fer calamine
Hierro calamina | 42
Grigio scuro
Dark grey
Gris foncé
Gris oscuro |



**Vivere
in relax**





Quadro

Il bello della reversibilità
Versatile Design — Un design polyvalent





Design versatile

Versatile Design — Un design polyvalent

ITA — Cura e originalità dei dettagli, uniti ad un design ricercato ma al contempo versatile, sono i tratti distintivi di QUADRO, ampio divano tre posti con chaise longue. Sia le spalliere che i braccioli sono infatti reversibili e pensati con rivestimenti personalizzabili, che abbinano il tessuto alla pelle. Il tutto esaltato da finiture rese uniche da una doppia bandina di pelle in contrasto cromatico. Dotato di braccioli reclinabili fino a novanta gradi e di poggiatesta movibili, QUADRO sorprende anche per la comodità delle sue imbottiture, contraddistinte da un'anima in poliuretano espanso e piuma d'oca.



— Mod. **Quadro**
Versioni 309 - 246 - 604
Divano con chaise longue
in pelle e tessuto.

ENG — Attention to details and originality, combined with a sophisticated and versatile design, are the distinctive features of QUADRO, a large three-seater sofa with chaise longue. Both the backrests and the armrests are indeed reversible and designed with customisable upholstery, which combine fabric and leather. All enhanced by finishes made unique by a double leather band with a contrasting colour. Featuring armrests that recline up to ninety degrees and removable headrests, QUADRO is also a surprise for its comfy padding, characterised by a polyurethane foam and goose down core.

FR — Des détails soignés et originaux unis à un design à la fois recherché et polyvalent sont les traits distinctifs de QUADRO, un grand canapé trois places avec méridienne. En effet, les coussins du dossier et des accoudoirs sont réversibles et conçus avec des revêtements personnalisables unissant le cuir et le tissu. Les finitions uniques grâce à la double bande en cuir contrastant avec les revêtements mettent en valeur tout le canapé. Pourvu d'accoudoirs inclinables à quatre-vingt-dix degrés maximum et d'appuis-tête amovibles, QUADRO surprend également par le confort des coussins, caractérisés par un rembourrage en polyuréthane expansé et en plumes d'oie.





Stile contemporaneo

Contemporary Style — Style Contemporain

ITA — La slitta in acciaio con finitura ferro calamina conferisce infine a questo divano - disponibile anche in versione tre posti grande - slancio ed un taglio decisamente contemporaneo.

ENG — Finally, the steel slide shaped leg with an iron calamine finishing gives this sofa - also available as a large three seater version - an astonishing and a contemporary style.

FR — Enfin, les pieds en forme de traîneau, avec finition calamine donnent à ce canapé - disponible également en version grand trois places - un esprit moderne et dynamique.



— Mod. **Quadro**
Versioni 304
Divano in pelle e tessuto.





Quadro



- | | | | |
|--|--|--|--|
| <p>— Rivestimento
Pelle / Tessuto parzialmente sfoderabile</p> <p>— Imbottitura
BRACCIOLI / Piuma
SEDUTA / Poliuretano espanso-Piuma
SPALLIERA / Piuma</p> <p>— Opzioni Cucitura a contrasto</p> <p>— Comfort Standard</p> <p>— Piedi Metallo</p> <p>— Struttura Telaio in legno</p> | <p>— Coverings
Leather / Fabric partially removable</p> <p>— Filling
ARMS / Feather
SEAT CUSHION / Foam-Feather
BACK CUSHION / Feather</p> <p>— Options Contrast stitching</p> <p>— Comfort Standard</p> <p>— Legs Metal</p> <p>— Structure Wooden frame</p> | <p>— Revêtement
Cuir / Tissu partiellement déhoussable</p> <p>— Rembourrage
ACCOUDOIRS / Plume
ASSISE / Mousse-Plume
DOSSIER / Plume</p> <p>— Options Coutures contrastées</p> <p>— Confort Standard</p> <p>— Pieds Metal</p> <p>— Structure Structure en bois</p> | <p>— Revestimiento
Piel / Tela parcialmente desfundable</p> <p>— Imbottitura
APOYABRAZOS / Pluma
SENTADA / Poliuretano expandido-Pluma
RESPALDO / Pluma</p> <p>— Opciones Costura en contraste</p> <p>— Confort Estándar</p> <p>— Pies Metal</p> <p>— Struttura Estructura en madera</p> |
|--|--|--|--|

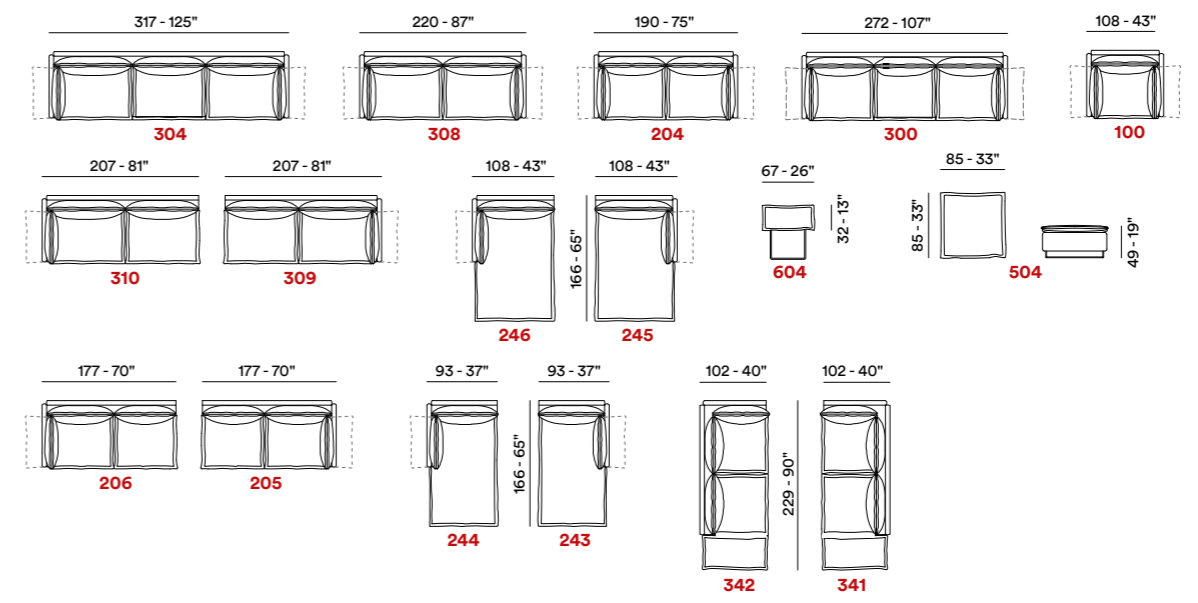

Esempi di componibilità — Sectionals examples — Exemples de compositions — Ejemplos de modularidad

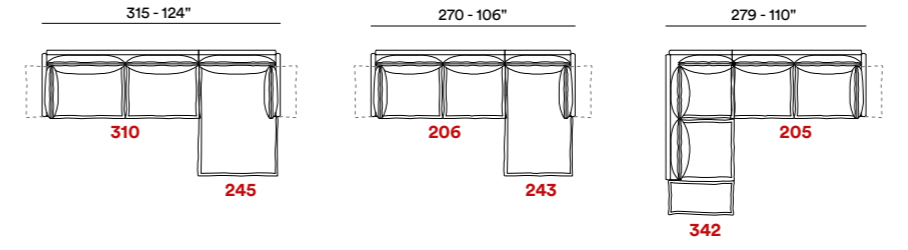

— **Modello brevettato** — Patented model

Finitura piedi — Legs finishes — Finition de pieds — Acabados de pies

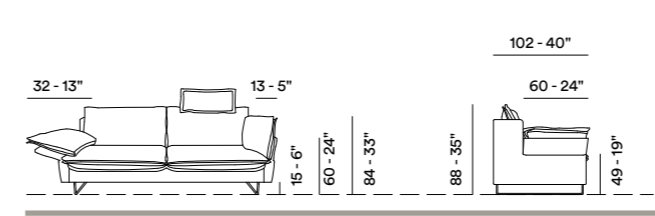

- | | | | | | |
|--|--|--|--|--|--|
| | | | | | |
|--|--|--|--|--|--|



Tok

Elegante e raffinato
Elegant and refined — Élegant et raffiné

Comfort e massima profondità seduta

Comfort and deeper seat — Comfort et une assise plus profonde



ITA — Spalliere caratterizzate da un funzionale meccanismo traslante che permette di aumentare la profondità di seduta.

ENG — Backrests featuring a functional sliding mechanism to increase the depth of the seats.

FR — Les dossiers sont caractérisés par un mécanisme de déplacement pratique qui permet d'augmenter la profondeur de l'assise.



— Tavolino Mod.
Ponza finitura 41/91.



— Mod. Tok
Versioni 310 - 341
Salotto angolare in pelle
con 3 spalliere traslanti.



Seduta modulare

Modular seating — Le canapé modulable



ITA — Salotto angolare in pelle effetto nabuk colore grigio antracite, spalliere trapuntate a ricorsi orizzontali dalla generosa altezza per comfort eccezionale.

ENG — Sectional in anthracite nubuck leather effect, quilted back paddle with horizontal recursive and generous height for an exceptional comfort.

FR — Salon d'angle en cuir effet nubuck de couleur gris anthracite avec dossiers matelassés aux surpiques horizontales et particulièrement hauts pour un confort exceptionnel.





Tavolino Panarea
finitura 41/18.



— Mod. **Tok**
Versioni 309 - 386
Salotto angolare in pelle
con 5 spalliere traslanti.





Tok



— Rivestimento

Pelle / Tessuto

— Imbottitura

BRACCIOLI / Poliuretano espanso

SEDUTA / Poliuretano espanso

SPALLIERA / Poliuretano espanso

— **Opzioni** Cucitura a contrasto

— **Comfort** Standard / Rigido

— **Piedi** Metallo

— **Struttura** Telaio in ferro e legno

— Coverings

Leather / Fabric

— Filling

ARMS / Foam

SEAT CUSHION / Foam

BACK CUSHION / Foam

— **Options** Contrast stitching

— **Comfort** Standard / Hard

— **Legs** Metal

— **Structure** Iron and wooden frame

— Revêtement

Cuir / Tissu

— Rembourrage

ACCOUDOIRS / Mousse

ASSISE / Mousse

DOSSIER / Mousse

— **Options** Coutures contrastées

— **Comfort** Standard / Fermé

— **Pieds** Metal

— **Structure** Structure en bois et fer

— Revestimiento

Piel / Tela

— Imbottitura

APOYABRAZOS / Poliuretano expandido

SENTADA / Poliuretano expandido

RESPALDO / Poliuretano expandido

— **Opciones** Costura en contraste

— **Comfort** Estándar / Duro

— **Pies** Metal

— **Struttura** Estructura en madera y hierro

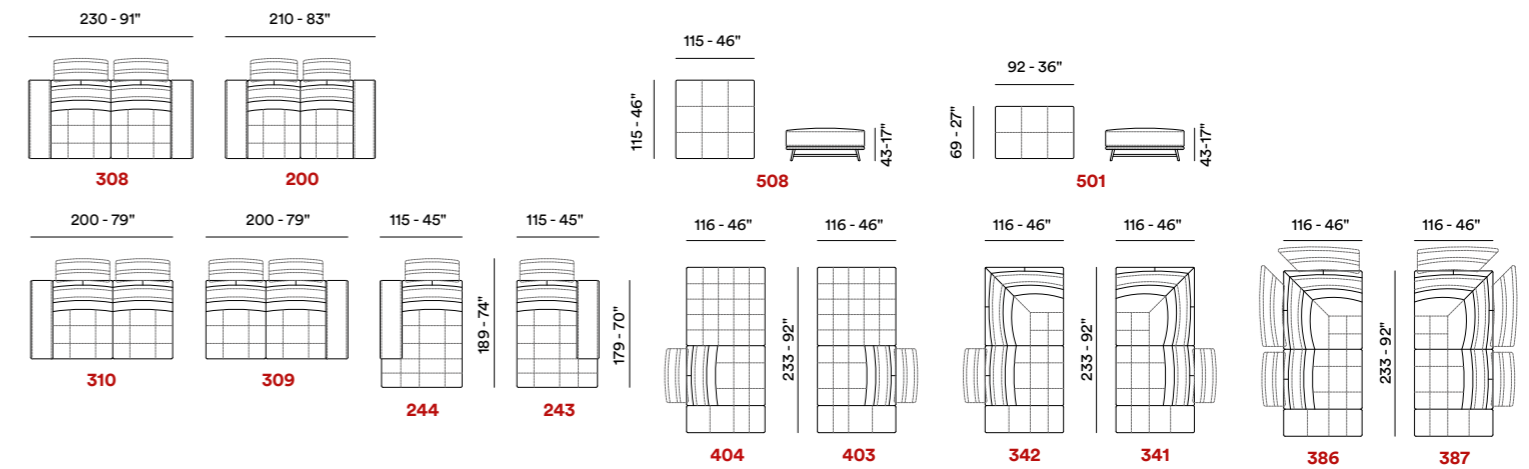

Esempi di componibilità — Sectionals examples — Exemples de compositions — Ejemplos de modularidad

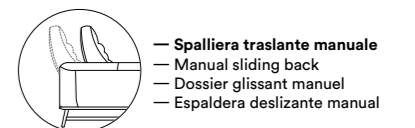
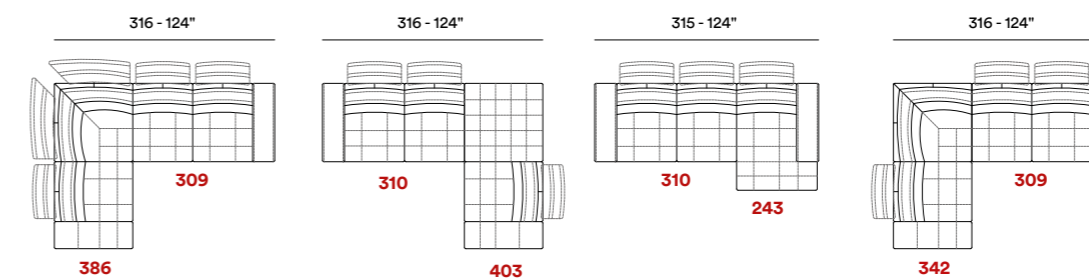

— Spalliera traslante manuale
— Manual sliding back
— Dossier glissant manuel
— Espaldera deslizante manual

— Modello brevettato — Patented model

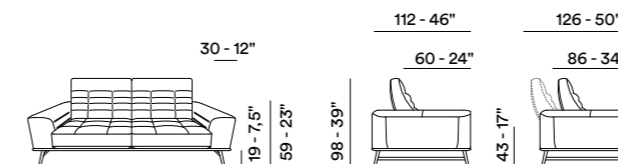

Finitura piedi — Legs finishes — Finition de pieds — Acabados de pies





**Specchi
che
riflettono**



— Tavolino Procida
finitura 10/90.

— Tavolino Procida
finitura 10/90.

— Tavolino Procida
finitura 10/90.



Esprit

Adatto ad ogni arredamento
Suitable for all styles furniture — Adapté à tous les styles



Particolari rifiniture

Finishing details — Finitions Particulières

ITA — Di alta fattura le rifiniture con particolare cucitura a punta di cavallo del bracciolo

ENG — With a high-end finish and special horseshoe stitching on the armrest.

FR — Les finitions sont de grande qualité avec une couture spéciale points de cheval au niveau des accoudoirs.



— Mod. **Esprit**
Versioni 310 - 400 - 145 - 604
Salotto angolare in tessuto.



— Tavolino Spargi 130
finitura 41/18.



— Tavolino **Tremiti**
finitura 41/90.



— Mod. **Esprit 3**
Versioni 206 - 341
Salotto angolare in pelle.



Adatto ad ogni arredamento

Suitable for all styles furniture — Adapté à tous les styles

ITA — Divano in tessuto o pelle molto versatile nelle dimensioni, curato nei particolari, seduta con profilo a “saponetta”, tipica dei guanciali, che fuoriesce dal bracciolo rendendo unico nel suo genere il fianco del modello. Imbottitura in poliuretano espanso a differenti densità, con piede in legno con o senza inserto in alluminio anodizzato.

ENG — Sofa available in fabric or leather, versatile in size, with special details and a seat with a “round” profile, typical of pillows, which protrudes from the armrest, making the side of the model unique. Polyurethane foam padding with different densities, wooden feet with or without anodized aluminum insert.

FR — Canapé disponible en tissu ou en cuir, plusieurs dimensions, avec des détails spéciaux et une assise avec un profil de finition typique des oreillers, qui dépasse de l'accoudoir, ce qui rend le côté du modèle unique. Rembourrage en polyuréthane expansé de différentes densités, pieds en bois sans ou avec profil en aluminium anodisé.





— Mod. **Esprit 2**
Versioni 300 - 600
Divano 3 posti in pelle.



— Tavolino Tremiti
finitura 41/90.

Esprit



- | | | | |
|---|---|--|--|
| <p>— Rivestimento
Pelle / Tessuto</p> <p>— Imbottitura
BRACCIOLI / Poliuretano espanso
SEDUTA / Poliuretano espanso
SPALLIERA / Poliuretano espanso</p> <p>— Opzioni Cucitura a contrasto</p> <p>— Comfort Standard / Rigido</p> <p>— Piedi Legno con profilo in alluminio</p> <p>— Struttura Telaio in legno</p> | <p>— Coverings
Leather / Fabric</p> <p>— Filling
ARMS / Foam
SEAT CUSHION / Foam
BACK CUSHION / Foam</p> <p>— Options Contrast stitching</p> <p>— Comfort Standard / Hard</p> <p>— Legs Wood with profile aluminium</p> <p>— Structure Wooden frame</p> | <p>— Revêtement
Cuir / Tissu</p> <p>— Rembourrage
ACCOUDOIRS / Mousse
ASSISE / Mousse
DOSSIER / Mousse</p> <p>— Options Coutures contrastées</p> <p>— Confort Standard / Fermé</p> <p>— Pieds Bois avec insert en métal</p> <p>— Structure Structure en bois</p> | <p>— Revestimiento
Piel / Tela</p> <p>— Imbottitura
APOYABRAZOS / Poliuretano expandido
SENTADA / Poliuretano expandido
RESPALDO / Poliuretano expandido</p> <p>— Opciones Costura en contraste</p> <p>— Confort Estándar / Duro</p> <p>— Pies Madera con perfil de aluminio</p> <p>— Struttura Estructura en madera</p> |
|---|---|--|--|

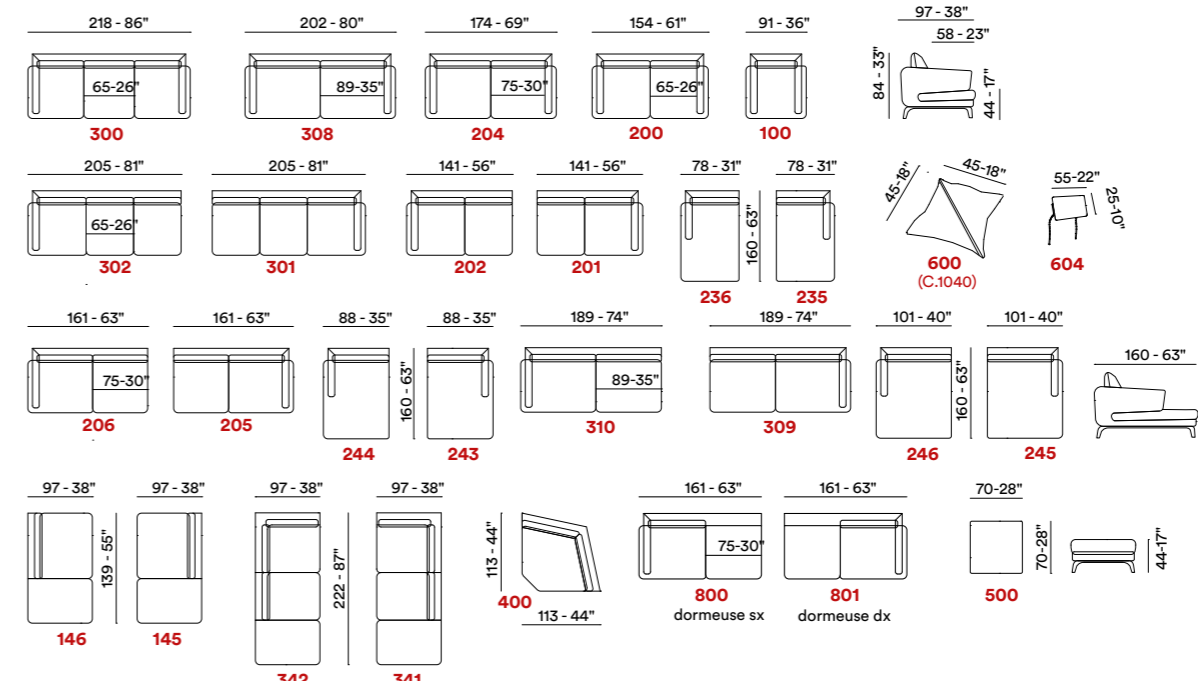

— **Esempi di componibilità** — Sectionals examples — Exemples de compositions — Ejemplos de modularidad

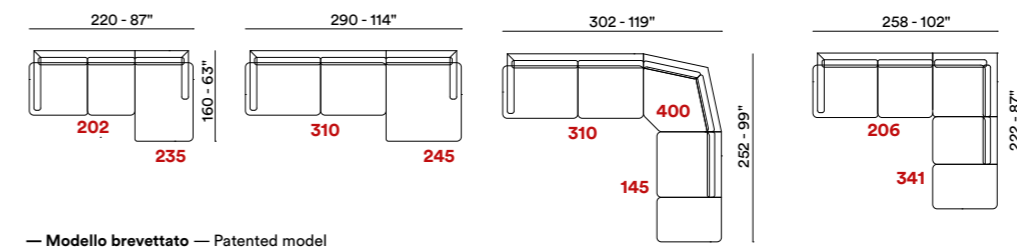

— **Modello brevettato** — Patented model



— **Finitura piedi** — Legs finishes — Finition de pieds — Acabados de pies

	<p>Esprit 3</p> <p>10 Lucido Chrome Brillant Brillante</p>	<p>Esprit 2</p> <p>22 Bronzato Bronze Bronze Bronce</p>	<p>26 Marrone Dark brown Marron Marrón</p>	<p>42 Grigio scuro Dark grey Gris foncé Gris oscuro</p>	<p>01 Naturale Natural Naturel Naturales</p>	<p>02 Ciliegio Cherry Merisier Cerezo</p>	<p>03 Noce Walnut Noyer Nuez</p>	<p>04 Noce brunito Dark walnut Noyer foncé Nogal dorado</p>	<p>06 Wengè Wengé Wengé Wengé</p>
--	---	--	---	--	---	--	---	--	--



Bebe

Design solido e imponente

Solid and impressive design — Un design puissant et imposant



— Tavolino Elba 100
finitura 41/91.

Design solido e imponente

Solid and impressive design — Un design puissant et imposant

ITA — Design solido e imponente per BEBE, vasto salotto angolare qui proposto nella versione tre posti con terminale ed angolo a trapezio completo di spalliera. Compatto e funzionale, BEBE è stato concepito per assicurare il massimo comfort in pochi semplici gesti: insieme al bracciolo reclinabile, tutte le spalliere - corredate da poggiatesta in piuma d'oca - sono infatti mobili, consentendo di aumentare la profondità della seduta fino a ben tredici centimetri.

— Mod. **Bebe**
Versioni 309 - 420 - 142
Salotto angolare in pelle
con 4 spalliere traslanti.



ENG — A solid and impressive design for BEBE, a large angular sofa shown here in its three-seater version with terminal and trapezoid corner complete with backrest. Compact and functional, BEBE has been designed to ensure maximum comfort in a few simple steps: together with the reclining armrest, all the backrests – with goose down lumbar pillows – are indeed removable, allowing for the depth of the seating to be increased by up to thirteen centimetres.

FR — Un design puissant et imposant pour BEBE, un grand canapé d'angle proposé ici dans la version trois places avec élément terminal et élément d'angle en forme de trapèze avec dossier. Compact et fonctionnel, BEBE a été conçu pour garantir un maximum de confort en quelques gestes simples: tous les accoudoirs inclinables, ainsi que les dossiers pourvus de coussins cale-rein en plumes d'oie sont en effet amovibles, pour augmenter la profondeur de l'assise jusqu'à un maximum de treize centimètres.





Dettagli sartoriali

Tailoring details — Détails de confection

ITA — Rivestito in vellutata pelle effetto nabuk, BEBE si distingue inoltre per i dettagli sartoriali delle finiture. La trapuntatura con “tiraggio” che esalta l’orizzontalità di spalliere e sedute, le cuciture con lavorazione a punta di cavallo con impunture a contrasto ed infine gli spigoli a vista con inserti in pelle, anch’essi in contrasto cromatico, rendono questo divano un prodotto unico, espressione compiuta di cura artigianale.

Il tutto poggia infine su piedini in finitura titanio e su telaio a struttura mista in ferro e legno, certezza di stabilità e resistenza all’uso quotidiano.

— Mod. Bebe
Versioni 310 - 420 - 141
Salotto angolare in pelle
con 4 spalliere traslanti.



ENG — Covered in velvety nubuck-effect leather, BEBE also stands out for the sartorial details of its finishes. The particular quilting that enhances the horizontality of the backrests and seats, the horseshoe stitching with contrasting seams and finally the visible edges with leather inserts, also with contrasting colours, make this sofa a unique product, the expression of craftsman like attention to detail.

It is supported by feet with a titanium finishing and on an iron and wood frame, ensuring stability and resistance to daily use.

FR — Revêtu en cuir effet nubuck au toucher velouté, BEBE se distingue en outre grâce aux détails des coutures. La surpiqûre au style « étiré » mettant en valeur l’horizontalité des dossiers et de l’assise, les coutures points de cheval de couleur contrastante et enfin les coins aux fentes apparentes avec insertions en cuir, elles aussi de couleur contrastante, transforment ce canapé en un produit unique, qui exprime le meilleur de la qualité artisanale.

Le châssis à structure mixte fer et bois reposant sur des pieds avec finition titane assure une grande stabilité et une grande résistance particulièrement adaptées à une utilisation quotidienne.



Bebe



— Rivestimento

Pelle / Tessuto

— Imbottitura

BRACCIOLI / Poliuretano espanso

SEDUTA / Poliuretano espanso

SPALLIERA / Poliuretano espanso

— **Opzioni** Cucitura a contrasto

— **Comfort** Standard / Rigido

— **Piedi** Metallo

— **Struttura** Telaio in ferro e legno

— Coverings

Leather / Fabric

— Filling

ARMS / Foam

SEAT CUSHION / Foam

BACK CUSHION / Foam

— **Options** Contrast stitching

— **Comfort** Standard / Hard

— **Legs** Metal

— **Structure** Iron and wooden frame

— Revêtement

Cuir / Tissu

— Rembourrage

ACCOUDOIRS / Mousse

ASSISE / Mousse

DOSSIER / Mousse

— **Options** Coutures contrastées

— **Comfort** Standard / Fermé

— **Pieds** Metal

— **Structure** Structure en bois et fer

— Revestimiento

Piel / Tela

— Imbottitura

APOYABRAZOS / Poliuretano expandido

SENTADA / Poliuretano expandido

RESPALDO / Poliuretano expandido

— **Opciones** Costura en contraste

— **Comfort** Estándar / Duro

— **Pies** Metal

— **Struttura** Estructura en madera y hierro

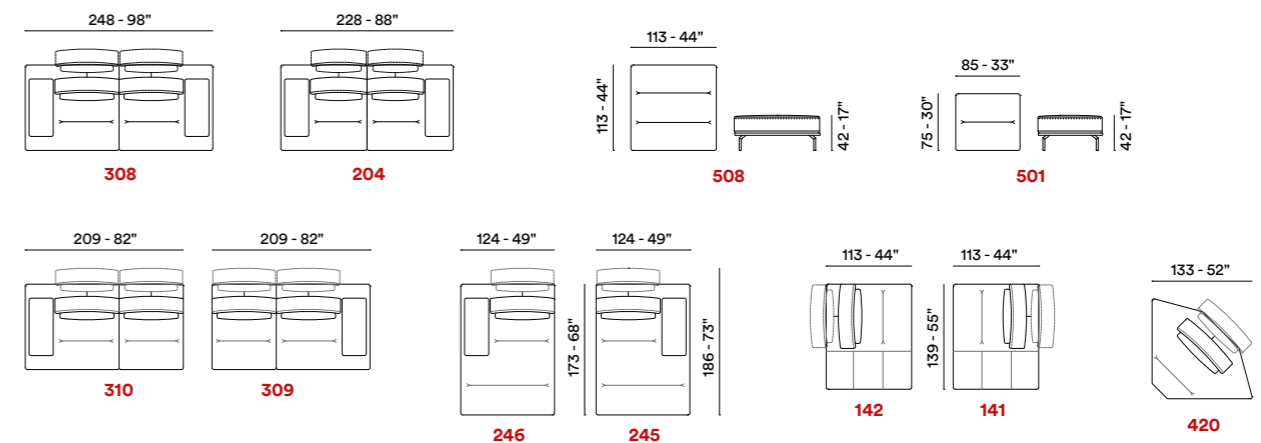

Esempi di componibilità — Sectionals examples — Exemples de compositions — Ejemplos de modularidad

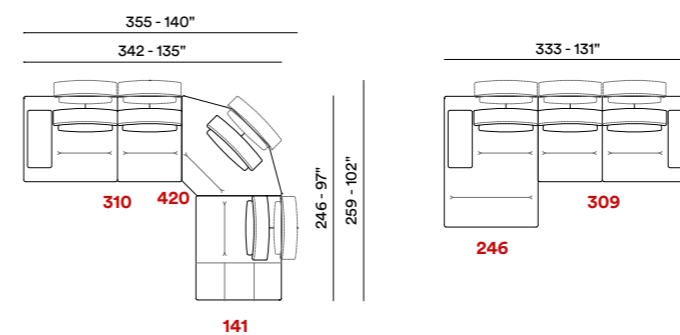

— Modello brevettato — Patented model

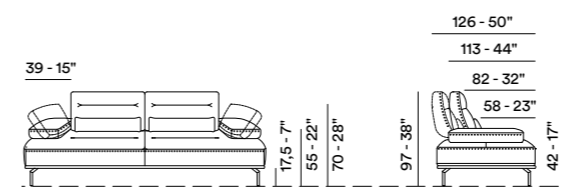

Finitura piedi — Legs finishes — Finition de pieds — Acabados de pies

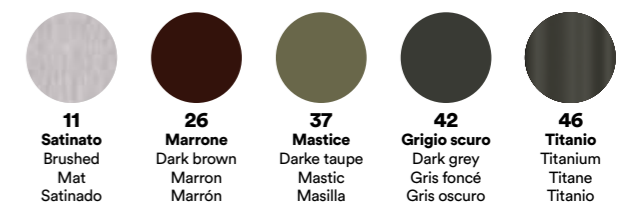



Noa

Fiore all'occhiello della collezione
The pride of our collection — Le fleuron de la collection



Fiore all'occhiello della collezione

The pride of our collection — Le fleuron de la collection



ITA — Noa racchiude in sé il retrò dei modelli anni 70, bracciolo leggermente sagomato, impuntura sulle spalliere e richiamo tradizionale della scocca in legno, in tutto ciò si inserisce un dettaglio di modernità dato dal particolare piede in color Nichel nero, il confort e le corrette dimensioni dei divani che arredano le case contemporanee. La finitura dei dettagli in legno è il noce canaletto, il salotto è disponibile con rivestimento in pelle o tessuto.

ENG — The pride of the MaxDivani Contemporary collection, Noa combines the vintage features of the '70s, thanks to its a slightly shaped armrest, topstitching on the backrests and a traditional wooden shell, with modern details given by the peculiar black nickel-coloured foot, its comfort and the correct dimensions of sofas that furnish contemporary homes. The wooden elements feature a canaletto walnut finish and the sofa is available with leather or fabric upholstery.

FR — Fleuron de la collection Contemporary Maxdivani, Noa incarne le style rétro des modèles des années 70 avec ses accoudoirs légèrement arrondis, des surpiques sur les coussins du dossier et une coque en bois rappelant la tradition. Les pieds de couleur nickel noir donnent une touche de modernité à ce canapé confortable aux dimensions idéales pour meubler les maisons contemporaines. Les éléments en bois ont une finition en noyer d'Amérique. Disponible avec revêtement en cuir ou en tissu.





— Tavolino **Ponza**
finitura 41/18.

Retrò contemporaneo

Contemporary retro — Rétro contemporain



— Mod. **Noa**
Versione 300
Divano 3 posti in tessuto
con profilo e fianchi finitura 18.



— Mod. **Noa**
 Versione 308
 Divano 3 posti in pelle
 con profilo e fianchi in tessuto.



Noa



— Rivestimento

Pelle / Tessuto

— Imbottitura

BRACCIOLI / Poliuretano espanso

SEDUTA / Poliuretano espanso

SPALLIERA / Poliuretano espanso

— **Opzioni** Cucitura a contrasto

— **Comfort** Standard / Rigido

— **Piedi** Metallo

— **Struttura** Telaio in legno

— Coverings

Leather / Fabric

— Filling

ARMS / Foam

SEAT CUSHION / Foam

BACK CUSHION / Foam

— **Options** Contrast stitching

— **Comfort** Standard / Hard

— **Legs** Metal

— **Structure** Wooden frame

— Revêtement

Cuir / Tissu

— Rembourrage

ACCOUDOIRS / Mousse

ASSISE / Mousse

DOSSIER / Mousse

— **Options** Coutures contrastées

— **Comfort** Standard / Fermé

— **Pieds** Metal

— **Structure** Structure en bois

— Revestimiento

Piel / Tela

— Imbottitura

APOYABRAZOS / Poliuretano expandido

SENTADA / Poliuretano expandido

RESPALDO / Poliuretano expandido

— **Opciones** Costura en contraste

— **Confort** Estándar / Duro

— **Pies** Metal

— **Estructura** Estructura en madera

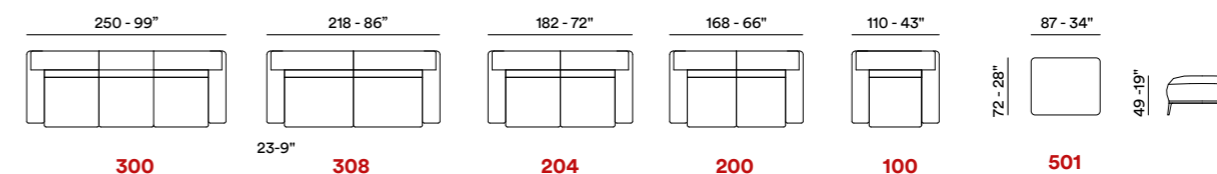

— **Modello brevettato** — Patented model

Molle greche — Zig Zag springs — Sangles métalliques nozag — Muelles ondulados



Finitura pannello bracciolo e base — Arm panel and base finishing — Finition coté accouider et base

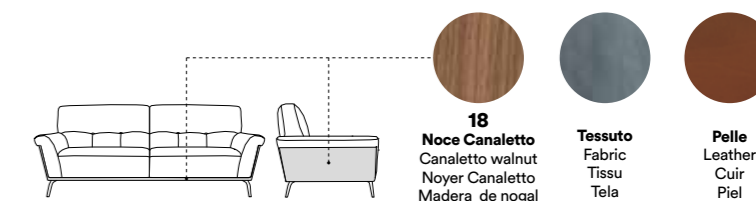

Finitura piedi — Legs finishes — Finition de pieds — Acabados de pies

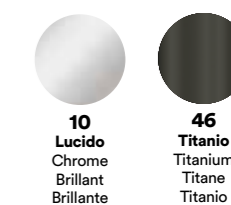
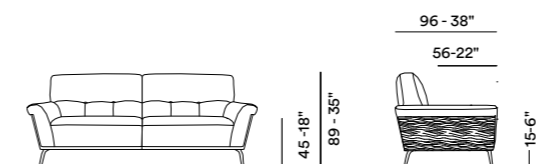



**Linee
morbide
ed
eleganti**



Cloud

Design sofisticato ed elegante

Sophisticated and elegant design — Un design sophistiqué et élégant



Design sofisticato ed elegante

Sophisticated and elegant design — Un design sophistiqué et élégant

ITA — Il divano CLOUD – disponibile nelle varianti due, tre posti o due posti con chaise longue – è espressione di un design sofisticato ed elegante. Caratterizzato dalla trapuntatura della spalliera sia nella parte anteriore che posteriore, CLOUD si presta ad essere collocato a centro stanza, diventando il centro catalizzatore di tutto lo spazio living.



— Mod. Cloud
Versioni 309 - 246
Divano con chaise longue in pelle.



ENG — The CLOUD sofa – available in different versions: two-seater, three-seater or two-seater with chaise longue - is the expression of a sophisticated and elegant design. Characterised by a backrest quilted on the front and back, CLOUD can be placed in the middle of the room, becoming the centre of the entire living space.

FR — Disponible à deux ou trois places ou à deux places avec méridienne, le canapé CLOUD est l'expression même d'un design sophistiqué et élégant. Caractérisé par les surpiques du dossier visibles aussi bien à l'arrière qu'à l'avant, CLOUD se place tout naturellement au centre de la pièce pour devenir le protagoniste du salon.



Cloud

Durevolezza e comfort

Comfort et durabilité — Comfort and durability



— Mod. Cloud
Versioni 309 - 245
Divano con chaise longue in pelle.



ITA — Ulteriori originali dettagli, che appagano il gusto per il bello, sono rappresentati dal bracciolo leggermente reclinato, dal bordino a contrasto delle finiture e dai particolari piedini in metallo strutturato. Il sistema “a molle greche” che ne caratterizza le imbottiture, rende inoltre CLOUD un divano particolarmente soffice, confortevole e di durevolezza assicurata.

ENG — Other original details, that satisfy your taste for beauty, are represented by the slightly reclined armrest, by the contrasting edge of the finishes and by the particular structured metal feet. The zig-zag spring system that characterises the padding also make CLOUD a particularly soft, comfortable and durable sofa.

FR — D'autres détails originaux régaleront les amateurs de beauté, comme les accoudoirs légèrement inclinés, les bordures contrastant avec la couleur du revêtement et la structure particulière des pieds en métal. Les ressorts Nosag qui caractérisent l'assise et le dossier font de CLOUD un canapé particulièrement moelleux, offrant un confort longue durée.



Cloud



— **Rivestimento**

Pelle / Tessuto

— **Imbottitura**

BRACCIOLI / Poliuretano espanso

SEDUTA / Poliuretano espanso

SPALLIERA / Poliuretano espanso

— **Opzioni** Cucitura a contrasto

— **Comfort** Standard

— **Piedi** Metallo

— **Struttura** Telaio in legno

— **Coverings**

Leather / Fabric

— **Filling**

ARMS / Foam

SEAT CUSHION / Foam

BACK CUSHION / Foam

— **Options** Contrast stitching

— **Comfort** Standard

— **Legs** Metal

— **Structure** Wooden frame

— **Revêtement**

Cuir / Tissu

— **Rembourrage**

ACCOUDOIRS / Mousse

ASSISE / Mousse

DOSSIER / Mousse

— **Options** Coutures contrastées

— **Confort** Standard

— **Pieds** Metal

— **Structure** Structure en bois

— **Revestimiento**

Piel / Tela

— **Imbottitura**

APOYABRAZOS / Poliuretano expandido

SENTADA / Poliuretano expandido

RESPALDO / Poliuretano expandido

— **Opciones** Costura en contraste

— **Confort** Estándar

— **Pies** Metal

— **Struttura** Estructura en madera

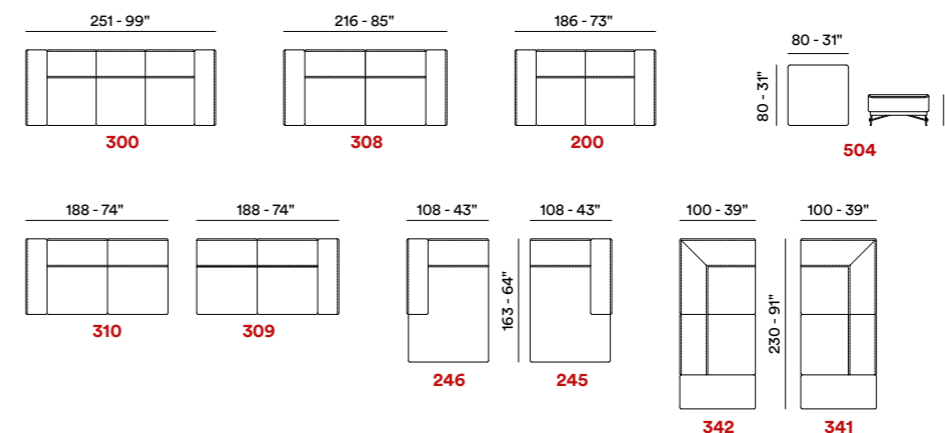

Esempi di componibilità — Sectionals examples — Exemples de compositions — Ejemplos de modularidad

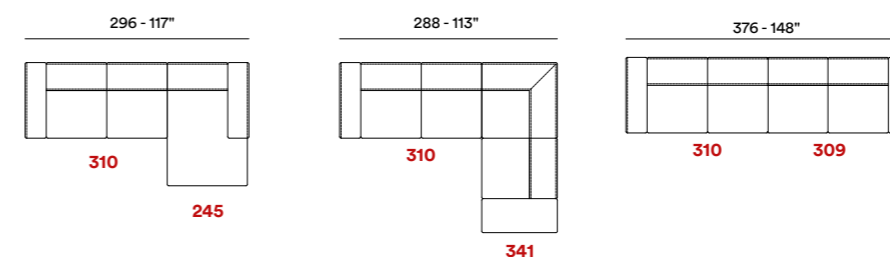

Molle greche — Zig Zag springs — Sangles métalliques nozag — Muelles onduladas

— **Modello brevettato** — Patented model

Finitura piedi — Legs finishes — Finition de pieds — Acabados de pies

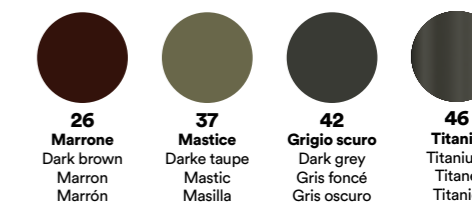
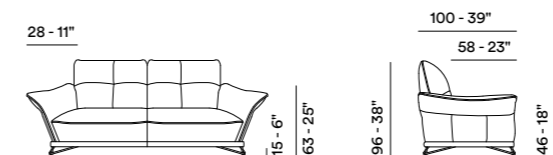



Design per natura



Kilt

Il tuo angolo lettura
Your reading corner — Votre coin lecture





Il tuo angolo lettura

Your reading corner — Votre coin lecture

ITA — Concepita per essere irradiata dalla soffusa luce di una lampada, la poltrona KILT è indispensabile per creare il perfetto angolo lettura.

Caratterizzata da forme tondeggianti e dalla spalliera alta e avvolgente, questa poltrona è un irresistibile invito a ritagliarsi una pausa relax. Accogliente e stabile, poggiando su saldi piedini in metallo, KILT è realizzata con rivestimento in tessuto, fatta eccezione per i dettagli in pelle delle originali “toppe” applicate sui braccioli. Può tuttavia essere richiesta in abbinamenti personalizzati di rivestimenti e colori in base al proprio gusto o esigenze di arredamento.

ENG — Designed to be radiated by the soft light of a lamp, the KILT armchair is essential to create the perfect reading corner. Characterised by rounded shapes and a tall and embracing backrest, this armchair is an irresistible invitation to carve out a relaxing break. Cosy and stable, resting on sturdy metal feet, KILT is made with fabric upholstery, except for the leather details of the original “patches” applied to the armrests. However, it is possible to request customised combinations of upholstery and colours based on one’s taste or furnishing needs.

FR — Conçu pour être baigné par la lumière douce d’une lampe, le fauteuil KILT est indispensable pour créer le coin lecture parfait. Caractérisé par des formes arrondies et par un dossier haut et enveloppant, ce fauteuil est une invitation irrésistible à la détente. Accueillant et stable, s’appuyant solidement sur des pieds en métal, KILT est réalisé avec un revêtement en tissu, à l’exception des détails originaux en cuir appliqués sur le dessus des accoudoirs. Il est toutefois possible de personnaliser les revêtements et les couleurs en fonction des goûts et des exigences d’ameublement.





Kilt



— **Rivestimento**

Pelle / Tessuto

— **Imbottitura**

BRACCIOLI / Poliuretano espanso

SEDUTA / Poliuretano espanso

SPALLIERA / Poliuretano espanso

— **Opzioni** Cucitura a contrasto

— **Comfort** Standard

— **Piedi** Metallo

— **Struttura** Telaio in legno

— **Coverings**

Leather / Fabric

— **Filling**

ARMS / Foam

SEAT CUSHION / Foam

BACK CUSHION / Foam

— **Options** Contrast stitching

— **Comfort** Standard

— **Legs** Metal

— **Structure** Wooden frame

— **Revêtement**

Cuir / Tissu

— **Rembourrage**

ACCOUDOIRS / Mousse

ASSISE / Mousse

DOSSIER / Mousse

— **Options** Coutures contrastées

— **Confort** Standard

— **Pieds** Metal

— **Structure** Structure en bois

— **Revestimiento**

Piel / Tela

— **Imbottitura**

APOYABRAZOS / Poliuretano expandido

SENTADA / Poliuretano expandido

RESPALDO / Poliuretano expandido

— **Opciones** Costura en contraste

— **Confort** Estándar

— **Pies** Metal

— **Struttura** Estructura en madera

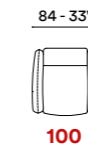
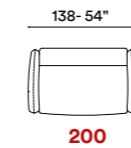
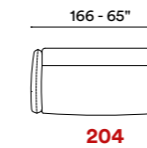

— **Modello brevettato** — Patented model

Finitura piedi — Legs finishes — Finition de pieds — Acabados de pies

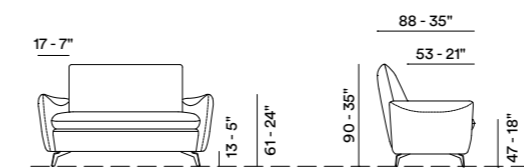

26
Marrone
Dark brown
Marron
Marrón



37
Mastice
Darke taupe
Mastic
Masilla



41
Ferro calamina
Calamine iron
Fer calamine
Hierro calamina



42
Grigio scuro
Dark grey
Gris foncé
Gris oscuro



Riflesso

Comfort & Design
Comfort & Design — Comfort & Design



Comfort & Design

Comfort & Design — Comfort & Design

ITA — Destinato ad arredare i grandi spazi con brio e spirito eclettico, RIFLESSO è un ampio divano angolare in cui l'estetica realizza un felice connubio con il comfort. Costituito da due moduli, tra cui è collocato in posizione angolare un terzo modulo dalla particolare base esagonale, RIFLESSO si distingue per i ricercati abbinamenti dei rivestimenti, qui proposti accostando un tessuto nelle tonalità del grigio ad un vellutato blu ciniglia.

ENG — Designed to furnish large spaces with liveliness and an eclectic spirit, RIFLESSO is a large angular sofa characterised by a combination of beauty and comfort. Made up of two modules, between which a third module is placed in an angular position with a special hexagonal base, RIFLESSO stands out for its refined upholstery, shown here by combining grey fabric with chenille blue velvet.

FR — Pensé pour meubler les grands espaces avec élégance et éclectisme, RIFLESSO est un grand canapé d'angle unissant avec brio esthétique et confort. Constitué de deux éléments reliés par un troisième élément d'angle de forme hexagonale, RIFLESSO se caractérise par l'union recherchée de différents revêtements, proposés ici avec un tissu dans les tons gris et un tissu chenille velouté bleu.



— Mod. **Riflesso**
Versioni 142 - 419 - 510 - 613 - 617 - 603 - 618 - 616 - 615
Salotto angolare in tessuto e spalliera in pelle.



Appeal decorativo

Decorative appeal — Appeal décoratif

ITA — A ciò si aggiunge la pelle della spalliera e del bracciolo: zavorrati e dunque completamente mobili, sono forniti come optional. Ulteriore dettaglio, che impreziosisce con cura sartoriale i rivestimenti, è dato dal bordino a contrasto, che va a definire con carattere i volumi di sedute, spalliere e bracciolo. Appeal spiccatamente decorativo è infine espresso dal gruppo centrale di cuscini e poggiatesta, caratterizzati da inediti accostamenti di colori e tipologie di rivestimento.



— Mod. Riflesso
Versioni 142 - 419 - 510 - 613 - 617 - 603 - 618
Salotto angolare in tessuto e spalliera in pelle.



ENG — Added to this is the leather of the backrest and armrest: ballasted and completely removable, they are supplied as an optional. Another detail that embellishes the upholstery with fine tailoring is represented by the contrasting edge, which gives character to the seats, backrests and armrest.

A strong decorative appeal is finally expressed by the central group of cushions and lumbar pillows, characterised by unusual combinations of colours and types of upholstery.

FR — À tout cela s'ajoute un dossier et un accoudoir en cuir fournis en option qui sont lestés et donc totalement amovibles. Les bordures de couleur contrastant avec les revêtements, qui définissent les volumes de l'assise, du dossier et de l'accoudoir, représentent un dernier détail de couture particulièrement soigné.

Pour finir, un charme extrêmement décoratif émane de l'ensemble de coussins et de cale-reins au centre de la composition, caractérisés par des juxtapositions inédites de couleurs et de matières



Riflesso



Riflesso



— Rivestimento

Pelle / Tessuto

— Imbottitura

BRACCIOLI / Poliuretano espanso

SEDUTA / Poliuretano espanso

SPALLIERA / Poliuretano espanso

— **Opzioni** Cucitura a contrasto

— **Comfort** Standard

— **Piedi** Metallo

— **Struttura** Telaio in legno

— Coverings

Leather / Fabric

— Filling

ARMS / Foam

SEAT CUSHION / Foam

BACK CUSHION / Foam

— **Options** Contrast stitching

— **Comfort** Standard

— **Legs** Metal

— **Structure** Wooden frame

— Revêtement

Cuir / Tissu

— Rembourrage

ACCOUDOIRS / Mousse

ASSISE / Mousse

DOSSIER / Mousse

— **Options** Coutures contrastées

— **Confort** Standard

— **Pieds** Metal

— **Structure** Structure en bois

— Revestimiento

Piel / Tela

— Imbottitura

APOYABRAZOS / Poliuretano expandido

SENTADA / Poliuretano expandido

RESPALDO / Poliuretano expandido

— **Opciones** Costura en contraste

— **Confort** Estándar

— **Pies** Metal

— **Struttura** Estructura en madera

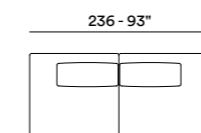

308

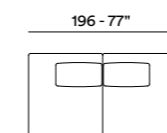

204

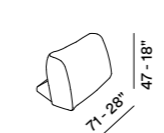

616

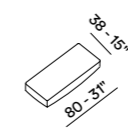

615

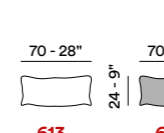

613

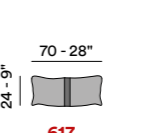

617

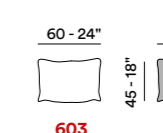

603

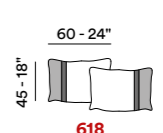

618

Bracciolo — Arm

Accoudoir — Apoyabrazo

Poggiarene decò — Backrest decò

Cale-rein decò — Trasero decò

Coppia cuscini decò — Paire cushions decò

Paiera de coussin decò — Pareja de cojines decò

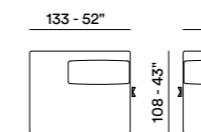

142

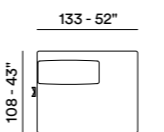

141

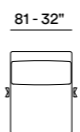

103

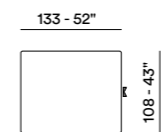

511

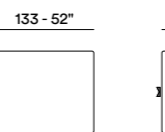

510

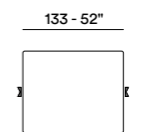

520

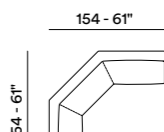

419

Esempi di componibilit — Sectionals examples — Exemples de compositions — Ejemplos de modularidad

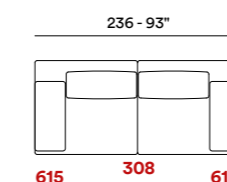
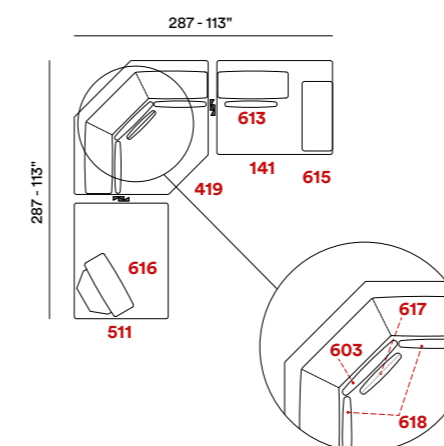

— **Modello brevettato** — Patented model

Molle greche — Zig Zag springs — Sangles métalliques nozag — Muelles onduladas



Finitura piedi — Legs finishes — Finition de pieds — Acabados de pies

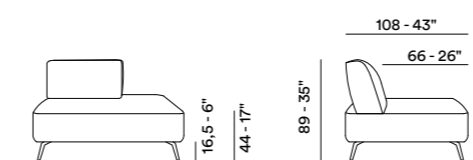

11
Satinato
Brushed
Mat
Satinado



26
Marrone
Dark brown
Marron
Marrón



37
Mastice
Dark taupe
Mastic
Masilla



42
Grigio scuro
Dark grey
Gris foncé
Gris oscuro

Urban living





Flam

Animo giovane e dinamico
Young and dynamic soul — Une âme jeune et dynamique



— Pouff Kubo

Animo giovane

Young soul — Une âme jeune

ITA — Flam è il divano tre posti con penisola terminale che, al bisogno, può diventare un comodo letto con materasso matrimoniale.

ENG — FLAM is the three-seater sofa with terminal peninsula which, when needed, can become a comfortable bed with a double mattress.

FR — FLAM est le canapé trois places avec méridienne terminale à l'âme jeune et dynamique qui, si besoin, peut devenir un lit confortable avec matelas deux places.



— Mod. **Flam**
Versioni 523 - 616
Chaise longue
totalmente sfoderabile.

— Mod. **Flam**
Versioni 329 - 523
Divano letto con penisola terminale,
totalmente sfoderabile.



Dinamico e cangiante

Dynamic and iridescent — Dynamique et changeant

ITA — Con le sue spalliere e poggiatestai volanti, cui si aggiunge l'optional di un'ulteriore spalliera zavorrata per la penisola, tutti in piuma d'oca e mobili FLAM lascia un segno indelebile grazie al suo doppio rivestimento, qui suggerito abbinando un morbido velluto color verde bosco ad un giocoso tessuto sfoderabile, proposto in una fantasia ispirata alla lussureggiante natura delle foreste tropicali.

ENG — With its loose backrests and lumbar cushions, to which another ballasted backrest for the peninsula can be added, all featuring goose down and removable – FLAM leaves an indelible mark thanks to its double upholstery, shown here combining a soft forest green velvet with a playful removable fabric, in this case featuring a pattern inspired by the lush nature of tropical forests. All finished with a contrasting grossgrain edge.

FR — avec des dossiers et des coussins cale-rein en plumes d'oie et amovibles, auxquels peut être ajouté un dossier lesté déplaçable en option pour la péninsule, FLAM laisse une marque indélébile grâce à son double revêtement suggéré ici en velours vert forêt unis à un tissu fantaisiste déhoussable, proposé avec des motifs s'inspirant à la nature luxuriante des forêts tropicales. Avec bordure en ruban gros grain de couleur contrastant avec le revêtement.



— Mod. Flam
Versioni 329 - 523 - 616 - 616
Divano letto con penisola
terminale e due spalliere,
totalmente sfoderabile.



Flam



— Rivestimento

Pelle / Tessuto

— Imbottitura

BRACCIOLI / Poliuretano espanso
 SEDUTA / Poliuretano espanso-Piuma
 SPALLIERA / Piuma

— **Opzioni** Cucitura a contrasto

— **Comfort** Standard

— **Piedi** Plastica

— **Struttura** Telaio in legno

— Coverings

Leather / Fabric

— Filling

ARMS / Foam
 SEAT CUSHION / Foam-Feather
 BACK CUSHION / Feather

— **Options** Contrast stitching

— **Comfort** Standard

— **Legs** Plastic

— **Structure** Wooden frame

— Revêtement

Cuir / Tissu

— Rembourrage

ACCOUDOIRS / Mousse
 ASSISE / Mousse-Plumes
 DOSSIER / Plumes

— **Options** Coutures contrastées

— **Confort** Standard

— **Pieds** Plastique

— **Structure** Structure en bois

— Revestimiento

Piel / Tela

— Imbottitura

APOYABRAZOS / Poliuretano expandido
 SENTADA / Poliuretano expandido-Piuma
 RESPALDO / Piuma

— **Opciones** Costura en contraste

— **Confort** Estándar

— **Pies** Plastic

— **Struttura** Estructura en madera

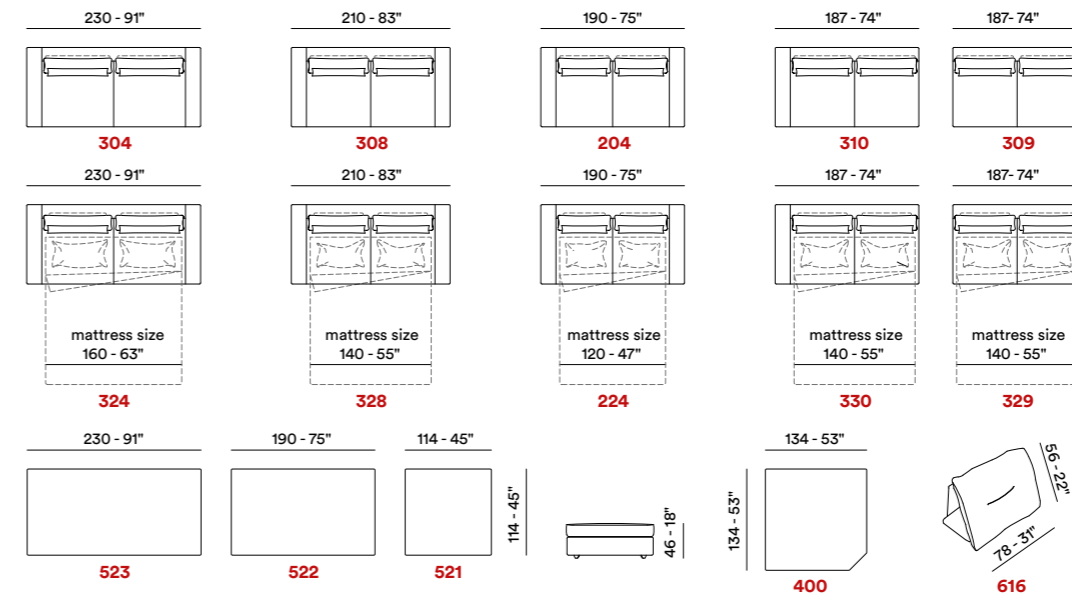

Esempi di componibilità — Sectionals examples — Exemples de compositions — Ejemplos de modularidad

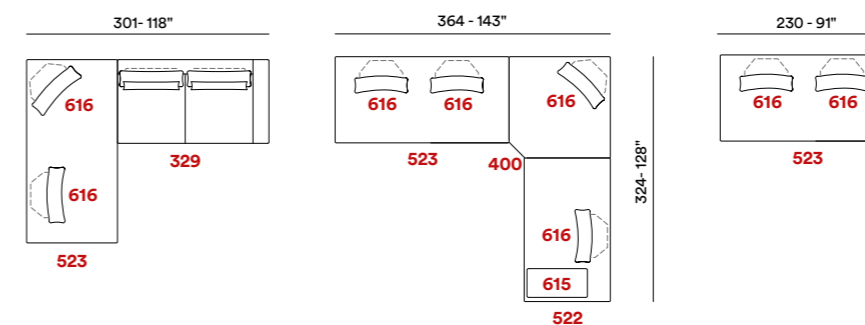

— **Modello brevettato** — Patented model

— Spalliera
 — Back cushion
 — Arm
 — Dossier
 — Respaldo

— Bracciolo
 — Arm
 — Accoudoir
 — Apoyabrazo

— Poggiarene
 — Backrest
 — Cale-rein
 — Trasero

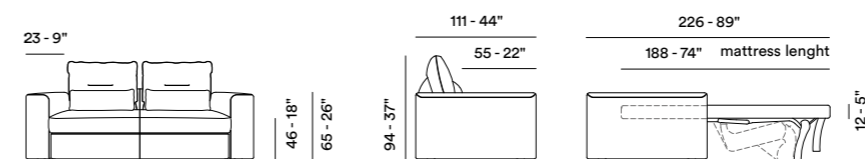



Asap

Comfort modulare

Modular comfort — Un confort modulaire



— Tavolino
Elba 100
finitura 41/91



Comfort modulare

Modular comfort — Un confort modulaire

ITA — ASAP è il divano modulare dallo spirito versatile, capace di assecondare con dinamismo gli spazi e le esigenze della vita contemporanea.

Concepito come poliedrica giustapposizione di moduli, ASAP si compone infatti di una poltrona in pelle con meccanismo recliner nel poggiatesta, cui vengono accostati un modulo poltrona centrale con rivestimento in tessuto ciniglia sfoderabile ed un pouf angolare mobile.

La composizione si completa infine con un divano letto tre posti con meccanismo a blocco unico, la cui spalliera — una volta aperto — diventa la testiera del letto.



— Mod. **Asap**
Versioni 320 - 125 - 504 - 125 - 119
Salotto angolare in pelle e tessuto
con divano letto e poltrona recliner.



ENG — ASAP is a modular sofa with a versatile spirit, able to dynamically pander to the spaces and needs of contemporary life. Designed as a multi-faceted juxtaposition of modules, ASAP is indeed made up of a leather armchair with a recliner mechanism in the footrest, which is combined with a central armchair module with removable chenille fabric upholstery and a removable corner pouf. Finally, the composition is completed with a three-seater sofa bed with a single-block mechanism, the backrest of which—once opened—becomes the headboard of the bed.

FR — ASAP est le canapé modulaire à l'esprit flexible, capable de meubler avec dynamisme les espaces et de répondre aux exigences de la vie moderne. Conçu comme une juxtaposition polyédrique de différents éléments, ASAP est composé d'un fauteuil en cuir avec repose-pied inclinable à côté d'un groupe central de fauteuils revêtus de tissu chenille déhoussable et d'un pouf d'angle amovible. Un canapé-lit trois places avec mécanisme d'ouverture composé d'un seul bloc, qui transforme le dossier du canapé en tête de lit complète la composition.





Asap



— **Rivestimento**

Pelle / Tessuto

— **Imbottitura**

BRACCIOLI / Poliuretano espanso

SEDUTA / Poliuretano espanso

SPALLIERA / Poliuretano espanso

— **Opzioni** Cucitura a contrasto

— **Comfort** Standard

— **Piedi** Plastica

— **Struttura** Telaio in legno

— **Coverings**

Leather / Fabric

— **Filling**

ARMS / Foam

SEAT CUSHION / Foam

BACK CUSHION / Foam

— **Options** Contrast stitching

— **Comfort** Standard

— **Legs** Plastic

— **Structure** Wooden frame

— **Revêtement**

Cuir / Tissu

— **Rembourrage**

ACCOUDOIRS / Mousse

ASSISE / Mousse

DOSSIER / Mousse

— **Options** Coutures contrastées

— **Confort** Standard

— **Pieds** Plastique

— **Structure** Structure en bois

— **Revestimiento**

Piel / Tela

— **Imbottitura**

APOYABRAZOS / Poliuretano expandido

SENTADA / Poliuretano expandido

RESPALDO / Poliuretano expandido

— **Opciones** Costura en contraste

— **Confort** Estándar

— **Pies** Plastic

— **Struttura** Estructura en madera

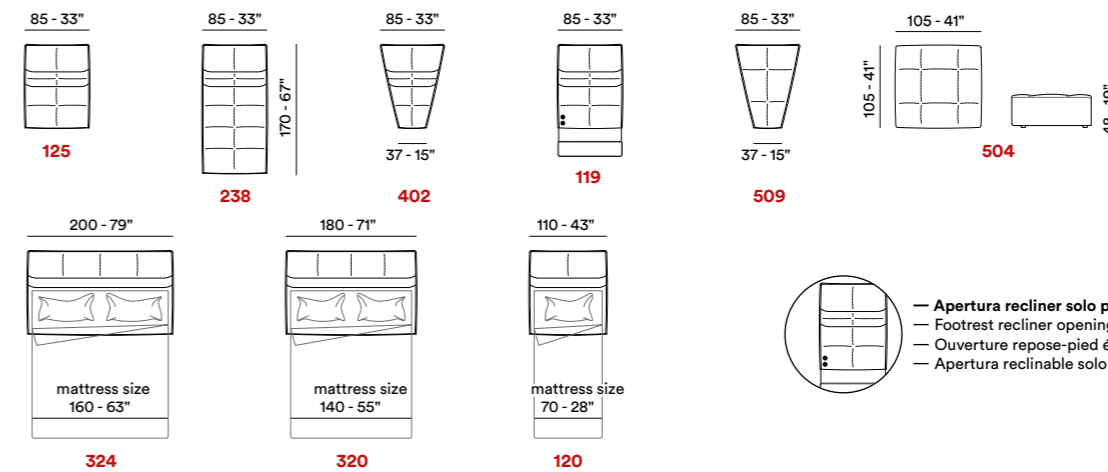

— **Esempi di componibilità** — Sectionals examples — Exemples de compositions — Ejemplos de modularidad

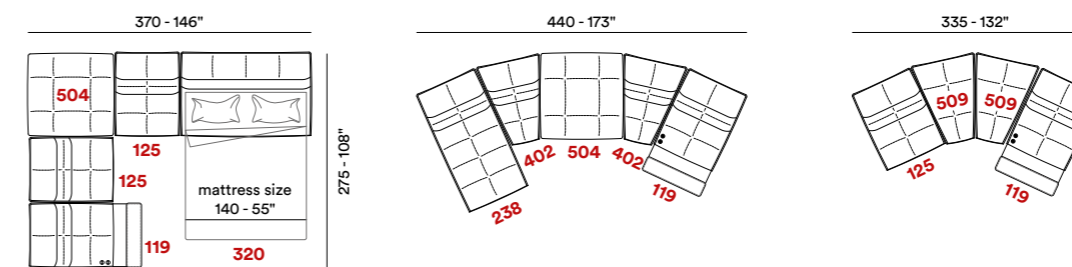

— **Modello brevettato** — Patented model

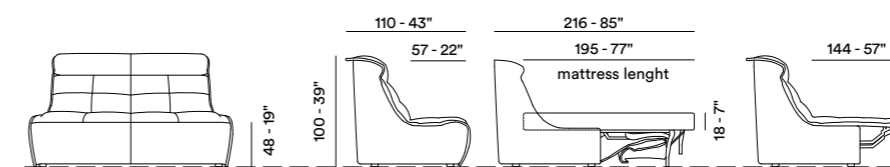



Raffaello

Semplice comodità
Simple comfort — Tout simplement confortable



— Mod. Raffaello
Versioni 2168 - 125 - 400 - 125 - 2169
Salotto angolare in microfibra
con doppia poltrona recliner.



— Tavolino **Procida**
finitura 41/91.

— Mod. **Raffaello**
Versioni 2168 - 2169 - 114 - 113
Divano 3 posti doppio recliner
e divano 2 posti fisso in pelle.



Relax assicurato

Perfect comfort — Détente garantie

ITA — Divano dal confort assicurato, **RAFFAELLO** - proposto in pelle color terracotta - è un modello dal design morbido e avvolgente, impreziosito dal dettaglio sartoriale della cucitura pizzicata, presente come motivo decorativo nelle spalliere e lungo i profili dei braccioli. Particolare decorativo è la trapuntatura per mezzo di una coppia di tiraggi sia per le sedute che per le spalliere, i divani sono sollevati da terra attraverso solide slitte in metallo.

ENG — Raffaello a sofa with an exceptional comfort, here in brick color leather - is a model with enveloping design, with a special pinched seam, presented as a decorative stitching on the back and part of the armrests.

A decorative detail is the quilting with a pair of tie-rod for the seats and backrests. the sofas are lifted off the ground by feet in the form of metal sleds.

FR — Raffaello, Le canapé avec un confort exceptionnel, proposé en cuir couleur terre cuite - est un modèle avec design enveloppant, avec détail de la couture pincée, présenté comme motif décoratif dans le dos et partie des accoudoirs. Un détail décoratif est le matelassage au moyen d'une paire de tirages pour les sièges et les dossiers. Les canapés sont soulevés du sol grâce à des pieds en forme de traîneaux métalliques.





Raffaello



— **Rivestimento**

Pelle / Tessuto

— **Imbottitura**

BRACCIOLI / Poliuretano espanso

SEDUTA / Poliuretano espanso

SPALLIERA / Poliuretano espanso

— **Opzioni** Cucitura a contrasto

— **Comfort** Standard / Rigido

— **Piedi** Metallo

— **Struttura** Telaio in legno

— **Coverings**

Leather / Fabric

— **Filling**

ARMS / Foam

SEAT CUSHION / Foam

BACK CUSHION / Foam

— **Options** Contrast stitching

— **Comfort** Standard / Hard

— **Legs** Metal

— **Structure** Wooden frame

— **Revêtement**

Cuir / Tissu

— **Rembourrage**

ACCOUDOIRS / Mousse

ASSISE / Mousse

DOSSIER / Mousse

— **Options** Coutures contrastées

— **Comfort** Standard / Fermé

— **Pieds** Metal

— **Structure** Structure en bois

— **Revestimiento**

Piel / Tela

— **Imbottitura**

APOYABRAZOS / Poliuretano expandido

SENTADA / Poliuretano expandido

RESPALDO / Poliuretano expandido

— **Opciones** Costura en contraste

— **Comfort** Estándar / Duro

— **Pies** Metal

— **Struttura** Estructura en madera

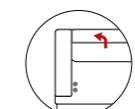
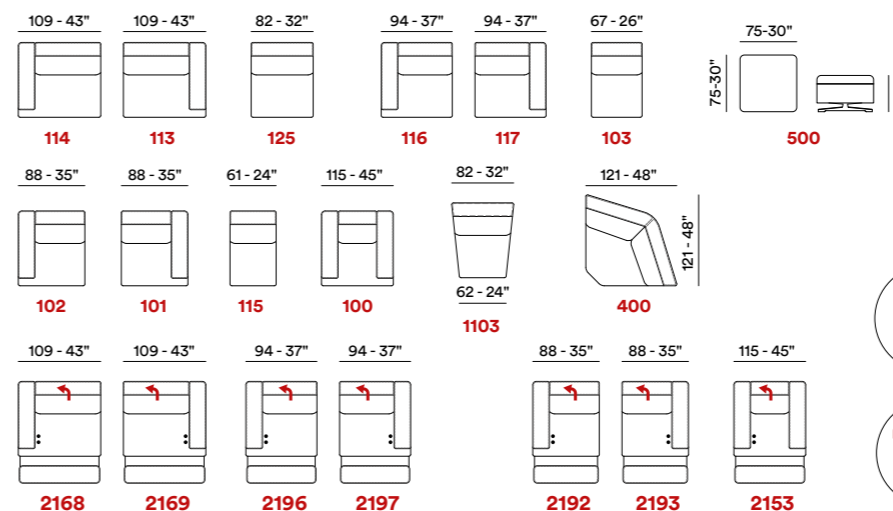

— **Apertura recliner con pulsantiera**
 — Recliner opening with button system
 — Relax électrique ayant un system boutons
 — Apertura reclinable con sistema de pulsadores



— **Poggiatesta elettrico**
 — Electric head-rest
 — Appui-tête électrique
 — Reposacabezas eléctrico

Esempi di componibilità — Sectionals examples — Exemples de compositions — Ejemplos de modularidad

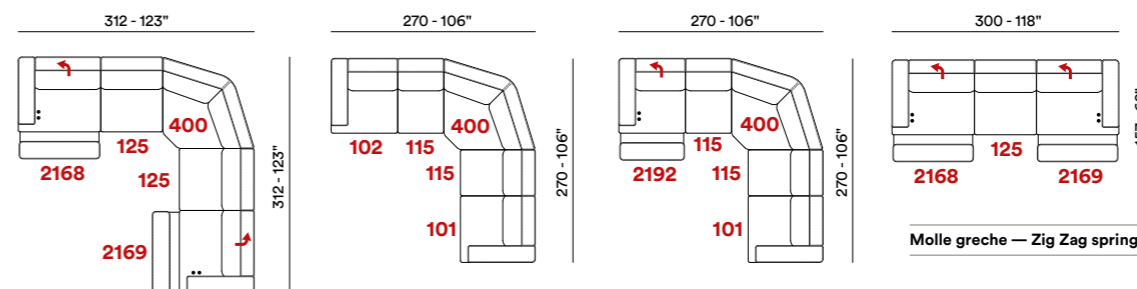

Molle greche — Zig Zag springs — Sangles métalliques nozag — Muelles onduladas

— **Modello brevettato** — Patented model

Finitura piedi — Legs finishes — Finition de pieds — Acabados de pies

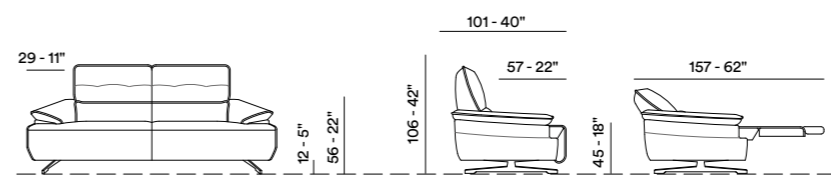

10
Lucido
 Chrome
 Brillant
 Brillante



11
Satinato
 Brushed
 Mat
 Satinado



41
Ferro calamina
 Calamine iron
 Fer calamine
 Hierro calamina



Regina

Tradizione e innovazione
Tradition and innovation — Tradition et innovation

Tradizione e innovazione

Tradition and innovation — Tradition et innovation

ITA — Ideale per l'ufficio, magnifica nel salotto di casa: la poltrona REGINA è il perfetto punto di incontro tra la migliore tradizione Made in Italy e la continua evoluzione di innovazione tecnologica e ricerca sui materiali. Concepita in un doppio rivestimento che unisce la pelle dei braccioli al tessuto di seduta e spalliera, REGINA è disponibile nella versione fissa con piedi in acciaio o girevole con basamento swivel.

ENG — Ideal for the office, magnificent in the living room of your home: the REGINA armchair is the perfect meeting point between the best tradition Made in Italy and the continuous evolution of technological innovation and research on materials. Designed with double upholstery that combines leather armrests with fabric seats and backrest, REGINA is available in the fixed version with steel feet or in the version with a swivel base.

FR — Idéal pour le bureau, magnifique dans un salon, le fauteuil REGINA est le point de rencontre parfait entre la meilleure tradition Made in Italy et l'évolution constante en matière d'innovation technologique et de recherche sur les matières. Conçu avec un double revêtement unissant le cuir des accoudoirs et le tissu de l'assise et du dossier, REGINA est disponible dans la version fixe avec pieds en acier et en version tournante avec piètement pivotant.



Regina



— Rivestimento

Pelle / Tessuto

— Imbottitura

BRACCIOLI / Poliuretano espanso

SEDUTA / Poliuretano espanso

SPALLIERA / Poliuretano espanso

— **Opzioni** Cucitura a contrasto

— **Comfort** Standard / Rigido

— **Piedi** Metallo

— **Struttura** Telaio in legno

— Coverings

Leather / Fabric

— Filling

ARMS / Foam

SEAT CUSHION / Foam

BACK CUSHION / Foam

— **Options** Contrast stitching

— **Comfort** Standard / Hard

— **Legs** Metal

— **Structure** Wooden frame

— Revêtement

Cuir / Tissu

— Rembourrage

ACCOUDOIRS / Mousse

ASSISE / Mousse

DOSSIER / Mousse

— **Options** Coutures contrastées

— **Confort** Standard / Fermé

— **Pieds** Metal

— **Structure** Structure en bois

— Revestimiento

Piel / Tela

— Imbottitura

APOYABRAZOS / Poliuretano expandido

SENTADA / Poliuretano expandido

RESPALDO / Poliuretano expandido

— **Opciones** Costura en contraste

— **Confort** Estándar / Duro

— **Pies** Metal

— **Struttura** Estructura en madera

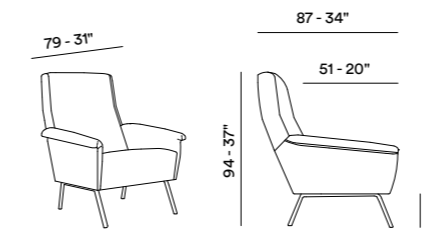

104

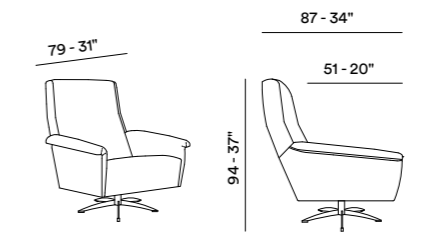

105

Molle greche — Zig Zag springs — Sangles métalliques nozag — Muelles onduladas



— Modello brevettato — Patented model

Finitura piedi — Legs finishes — Finition de pieds — Acabados de pies

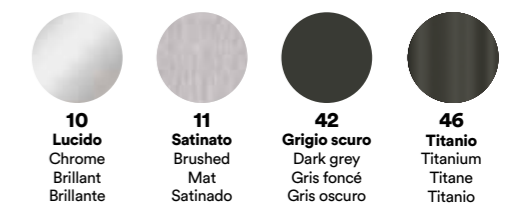

10
Lucido
Chrome
Brillant
Brillante

11
Satinato
Brushed
Mat
Satinado

42
Grigio scuro
Dark grey
Gris foncé
Gris oscuro

46
Titanio
Titanium
Titane
Titanio



Blenda

Appeal contemporaneo
Contemporary appeal — Un charme contemporain



Appeal contemporaneo

Contemporary appeal — Un charme contemporain

ITA — Appeal spiccatamente contemporaneo per la poltroncina BLENDA, disegnata — nella sua doppia versione, fissa con piedi a cono in metallo o swivel — per lasciare il segno sia nel living che in ambienti contract. Dalle avvolgenti forme arrotondate, è caratterizzata dal design a pozzetto, con schienale e braccioli concepiti come un unico blocco continuo. Solida, nel suo telaio in robusto legno, BLENDA può essere personalizzata con infinite possibilità di abbinamenti di pelli e tessuti.

ENG — A distinctly contemporary appeal for the BLENDA armchair, designed — in its two versions, fixed with metal cone feet or swivel — to leave a mark both in the living room and in contract environments. With its cosy rounded shapes, it features a backrest and armrests designed as a single continuous block. Solid, in its sturdy wooden frame, BLENDA can be customised with endless possibilities for matching leather and fabrics.

FR — Un charme particulièrement contemporain caractérise le petit fauteuil BLENDA conçu en deux versions : fixe avec des pieds coniques en métal ou pivotant, qui se fait remarquer aussi bien dans un salon que dans des espaces collectifs. Avec ses formes arrondies enveloppantes, ce fauteuil se caractérise par un design circulaire, avec un dossier et des accoudoirs monobloc. Solide grâce à sa structure en bois résistant, BLENDA peut être personnalisé avec un nombre infini de combinaisons de cuirs et de tissus.



Blenda



— Rivestimento

Pelle / Tessuto

— Imbottitura

BRACCIOLI / Poliuretano espanso

SEDUTA / Poliuretano espanso

SPALLIERA / Poliuretano espanso

— **Opzioni** Cucitura a contrasto

— **Comfort** Standard

— **Piedi / Swivel** Metallo

— **Struttura** Telaio in legno

— Coverings

Leather / Fabric

— Filling

ARMS / Foam

SEAT CUSHION / Foam

BACK CUSHION / Foam

— **Options** Contrast stitching

— **Comfort** Standard

— **Legs / Swivel** Metal

— **Structure** Wooden frame

— Revêtement

Cuir / Tissu

— Rembourrage

ACCOUDOIRS / Mousse

ASSISE / Mousse

DOSSIER / Mousse

— **Options** Coutures contrastées

— **Confort** Standard

— **Pieds / Swivel** Metal

— **Structure** Structure en bois

— Revestimiento

Piel / Tela

— Imbottitura

APOYABRAZOS / Poliuretano expandido

SENTADA / Poliuretano expandido

RESPALDO / Poliuretano expandido

— **Opciones** Costura en contraste

— **Confort** Estándar

— **Pies / Swivel** Metal

— **Struttura** Estructura en madera

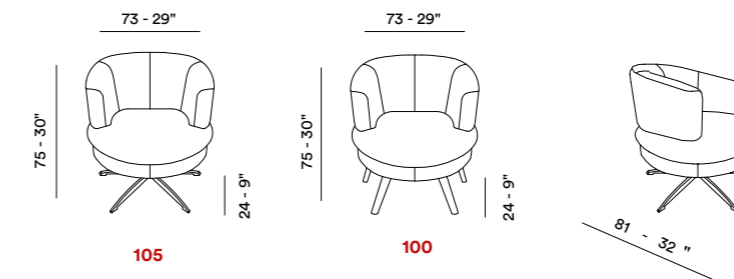

— Modello brevettato — Patented model

Finitura piedi — Legs finishes — Finition de pieds — Acabados de pies

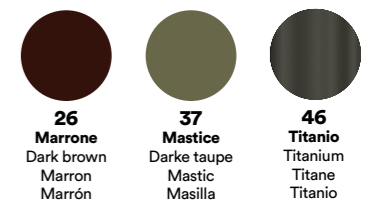



Dalia

Comfort sartoriale

Tailored comfort — Un confort «haute couture»



Comfort sartoriale

Tailored comfort — Un confort « haute couture »

ITA — Avvolgente come un abbraccio, la poltrona DALIA — caratterizzata dal design a pozzetto e dallo schienale trapuntato - è la dimensione perfetta per ritagliarsi un momento di relax, magari in compagnia di un buon libro. Espressione di uno stile spiccatamente contemporaneo, è poggiata su solide slitte metalliche, che le conferiscono respiro e leggerezza.

ENG — Like a warm embrace, the DALIA armchair - characterised by a tub seat design and a quilted backrest - is the perfect size for a moment of relaxation, perhaps in the company of a good book. An expression of a distinctly contemporary style, it rests on solid metallic sledges, which give it a sense of space and lightness.

FR — Enveloppant comme une étreinte, le fauteuil DALIA - caractérisé par un design en crapaud et un dossier matelassé - est de la taille parfaite pour un moment de détente, peut-être en compagnie d'un bon livre. Expression d'un style résolument contemporain, il repose sur des pieds métalliques solides qui lui confèrent souffle et légèreté.



Dalia



— Rivestimento

Pelle / Tessuto

— Imbottitura

BRACCIOLI / Poliuretano espanso

SEDUTA / Poliuretano espanso

SPALLIERA / Poliuretano espanso

— **Opzioni** Cucitura a contrasto

— **Comfort** Standard

— **Piedi** Metallo

— **Struttura** Telaio in legno

— Coverings

Leather / Fabric

— Filling

ARMS / Foam

SEAT CUSHION / Foam

BACK CUSHION / Foam

— **Options** Contrast stitching

— **Comfort** Standard

— **Legs** Metal

— **Structure** Wooden frame

— Revêtement

Cuir / Tissu

— Rembourrage

ACCOUDOIRS / Mousse

ASSISE / Mousse

DOSSIER / Mousse

— **Options** Coutures contrastées

— **Confort** Standard

— **Pieds** Metal

— **Structure** Structure en bois

— Revestimiento

Piel / Tela

— Imbottitura

APOYABRAZOS / Poliuretano expandido

SENTADA / Poliuretano expandido

RESPALDO / Poliuretano expandido

— **Opciones** Costura en contraste

— **Confort** Estándar

— **Pies** Metal

— **Struttura** Estructura en madera

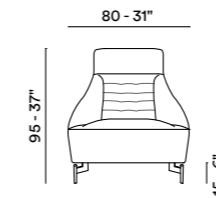

100

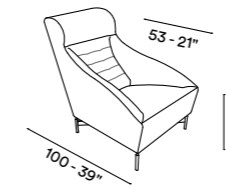

106

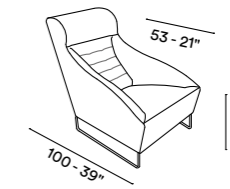

— Modello brevettato — Patented model

Finitura piedi — Legs finishes — Finition de pieds — Acabados de pies



10
Lucido
Chrome
Brillant
Brillante



11
Satinato
Brushed
Mat
Satinado



26
Marrone
Dark brown
Marron
Masilla



37
Mastice
Dark taupe
Mastic
Masilla

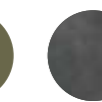

41
Ferro calamina
Calamine iron
Fer calamine
Hierro calamina



42
Grigio scuro
Dark grey
Gris foncé
Gris oscuro



Doroty

Lo stile della comodità
Le style confortable — Le style confortable

Lo stile della comodità

The style of comfort — Le style confortable

ITA — Poltrona reclinare versatile ed elegante, si contraddistingue per la sua trapuntatura orizzontale e dal bracciolo con una sagoma che si apre verso l'esterno. Con piedini in legno finitura noce brunito la poltrona Doroty ben si inserisce sia in ambienti giorno che notte o in angoli lettura per i momenti di meritato relax.

ENG — Versatile and elegant recliner armchair, it stands out for its horizontal quilting and its armrest with a shape that opens outwards. With wooden feet with a burnished walnut finish, the Doroty armchair can be placed in living rooms and in bedrooms or in reading corners for moments of well-deserved relaxation.

FR — Fauteuil inclinable polyvalent et élégant, il se distingue par la surpiqure horizontale et par la forme des accoudoirs tournés vers l'extérieur. Avec des pieds en bois finition noyer bruni, le fauteuil Doroty s'adapte aussi bien aux salons qu'aux chambres ou aux coins lectures pour des moments de détente bien mérités.



Doroty



— **Rivestimento**

Pelle / Tessuto

— **Imbottitura**

BRACCIOLI / Poliuretano espanso

SEDUTA / Poliuretano espanso

SPALLIERA / Poliuretano espanso

— **Opzioni** Cucitura a contrasto

— **Comfort** Standard / Rigido

— **Piedi** Legno

— **Struttura** Telaio in legno

— **Coverings**

Leather / Fabric

— **Filling**

ARMS / Foam

SEAT CUSHION / Foam

BACK CUSHION / Foam

— **Options** Contrast stitching

— **Comfort** Standard / Hard

— **Legs** Wood

— **Structure** Wooden frame

— **Revêtement**

Cuir / Tissu

— **Rembourrage**

ACCOUDOIRS / Mousse

ASSISE / Mousse

DOSSIER / Mousse

— **Options** Coutures contrastées

— **Confort** Standard / Fermé

— **Pieds** Bois

— **Structure** Structure en bois

— **Revestimiento**

Piel / Tela

— **Imbottitura**

APOYABRAZOS / Poliuretano expandido

SENTADA / Poliuretano expandido

RESPALDO / Poliuretano expandido

— **Opciones** Costura en contraste

— **Confort** Estándar / Duro

— **Pies** Madera

— **Struttura** Estructura en madera

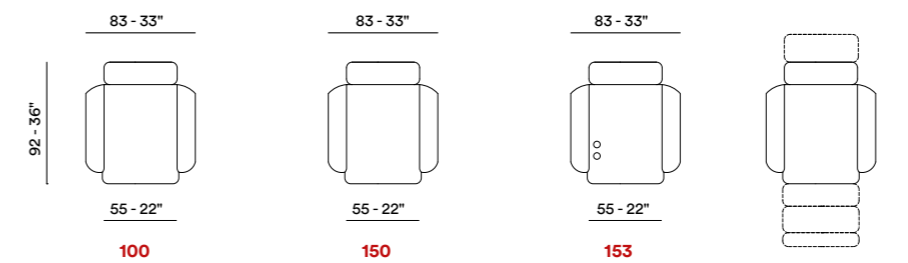

— **Modello brevettato** — Patented model

Finitura piedi — Legs finishes — Finition de pieds — Acabados de pies

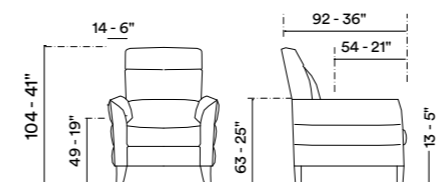

- 
01
Naturale
 Natural
 Naturel
 Naturales
- 
02
Ciliegio
 Cherry
 Merisier
 Cerezo
- 
03
Noce
 Walnut
 Noyer
 Nuez
- 
04
Noce brunito
 Dark walnut
 Noyer foncé
 Nogal dorado
- 
06
Wengè
 Wengè
 Wengé
 Wengé
- 
09
Alluminio
 Aluminium
 Aluminium
 Aluminio
- 
12
Sbiancato
 White washed
 Céruse
 Blanqueado

Essenza e design



Complementi

Accessories — Accessoires — Accesorios

Tavoli

Tables — Table — Tablas
→ 190

Cuscini

Pillows — Coussin — Almohadas
→ 194

Tappeti

Rugs — Tapis — Alfombras
→ 195

Pouf

Footool — Pouf — Otomana
→ 196

Tavoli

Tables — Table — Tablas

Ponza



1702

Finiture — Finishing — Finition — Acabados
90 - 91 - 18
10 - 11 - 41

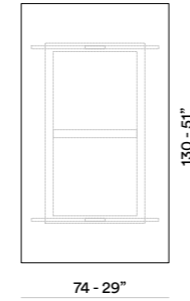
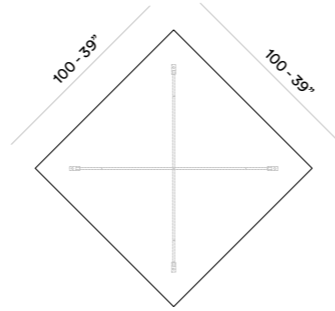

74 - 29"

130 - 51"

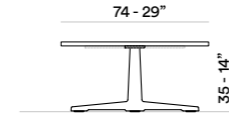

1706

Finiture — Finishing — Finition — Acabados
90 - 91 - 18
10 - 11 - 41

Procida



Elba 100

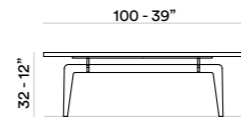

1702

Finiture — Finishing — Finition — Acabados
90 - 91 - 18
10 - 11 - 41

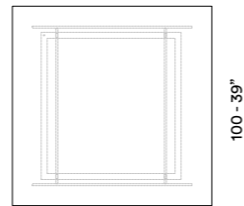

100 - 39"

Elba 130

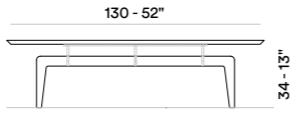

1703

Finiture — Finishing — Finition — Acabados
90 - 91 - 18
10 - 11 - 41

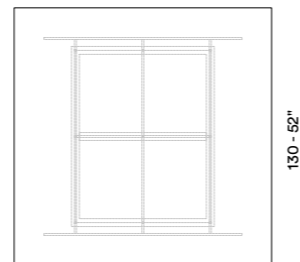

130 - 52"

Panarea

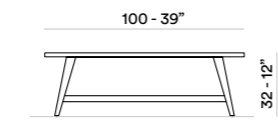

1702

Finiture — Finishing — Finition — Acabados
90 - 91 - 18
10 - 11 - 41

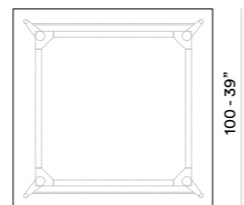

100 - 39"

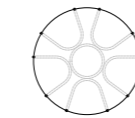

42 - 17"

Lipari 42

Finiture — Finishing — Finition — Acabados
90 - 91
10 - 11

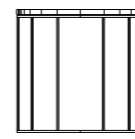
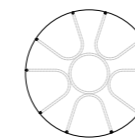

50 - 20"

Lipari 50

Finiture — Finishing — Finition — Acabados
90 - 91
10 - 11

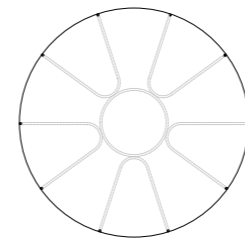

90 - 35"

Lipari 90

Finiture — Finishing — Finition — Acabados
90 - 91
10 - 11

Lipari



Tavoli

Tables — Table — Tablas

Spargi

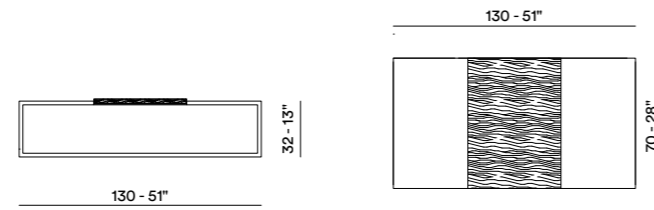
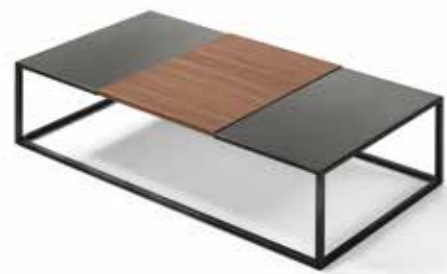

Spargi 1706

Finiture — Finishing — Finition — Acabados
90 - 91 - 18
41

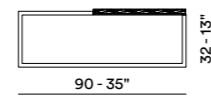

Spargi 1702

Finiture — Finishing — Finition — Acabados
90 - 91 - 18
41

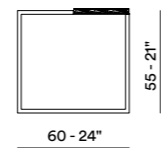

Spargi 1708

Finiture — Finishing — Finition — Acabados
90 - 91 - 18
41

Ischia

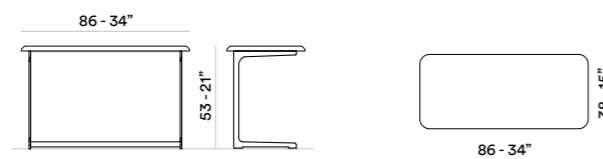

703

Finiture — Finishing — Finition — Acabados
90 - 91 - 18
10 - 11 - 41

Capri

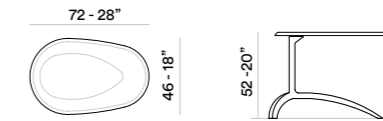

1703

Finiture — Finishing — Finition — Acabados
90 - 91 - 18
10 - 11 - 41

Tremiti



1704

Finiture — Finishing — Finition — Acabados
90 - 91
10 - 11 - 41

Finiture ripiano — Table top finishing — Finition table — Acabados tablas



90
Marmo marrone
Brown marble
Marbre brun
Mármol marrón



91
Marmo bianco
White marble
Marbre blanc
Mármol blanco

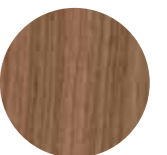

18
Noce canaletto
Canaletto walnut
Bois noyer canaletto
Madera de nogal

Finiture struttura — Frame finishing — Finition structure — Acabados estructura



10
Lucido
Polished
Brillant
Brillante



11
Satinato
Satin
Mat
Satinado



41
Ferro calamina
Clamine iron
Fer calamine
Hierro calamina

Cuscini

Pillows — Coussin — Almohadas

— C1033

Pelle / Tessuto
Leather / Fabric
Cuir / Tissue
Piel / Tela

Piuma
Feather
Plumes
Pluma

66x66 cm — 26"x26"



— C1006

Pelle / Tessuto
Leather / Fabric
Cuir / Tissue
Piel / Tela

Fibra di poliestere
Fiber
Flocons de polyester
Fibras de poliéster

45x45 cm — 18"x18"



— C1036

Pelle / Tessuto
Leather / Fabric
Cuir / Tissue
Piel / Tela

Poliuretano espanso
Foam
Mousse
Poliuretano expandido

60x60 cm — 24"x24"



— C1039

Pelle / Tessuto
Leather / Fabric
Cuir / Tissue
Piel / Tela

Poliuretano espanso
Foam
Mousse
Poliuretano expandido

55x55 cm — 22"x22"



— C1046

Pelle / Tessuto
Leather / Fabric
Cuir / Tissue
Piel / Tela

Fibra di poliestere
Fiber
Flocons de polyester
Fibras de poliéster

45x45 cm — 18"x18"



— C1047

Pelle / Tessuto
Leather / Fabric
Cuir / Tissue
Piel / Tela

Piuma
Feather
Plumes
Pluma

40x40 cm — 16"x16"



— C1008

Pelle / Tessuto
Leather / Fabric
Cuir / Tissue
Piel / Tela

Fibra di poliestere
Fiber
Flocons de polyester
Fibras de poliéster

45x45 cm — 18"x18"



— C1040

Pelle / Tessuto
Leather / Fabric
Cuir / Tissue
Piel / Tela

Piuma
Feather
Plumes
Pluma



Tappeti

Rugs — Tapis — Alfombras

Tapal



— xxTAPTAP200

Composizione: 20% Co 30% PL+ 50% PC
Peso totale: 1.150 gr/m²

200x290 cm — 79"x79"

Sephora



— xxTAPSEP200

Composizione: 30% Co 20% PL+ 50% PC
Peso totale: 1.850 gr/m²

200x290 cm — 79"x79"

Finiture Tappeti — Rug finishing — Finitions tapis — Acabados alfombras

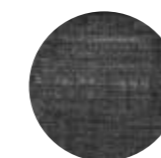

BLACK

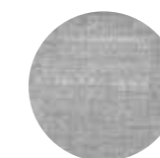

SILVER



TAUPE



SKY



BLACK



SILVER



BEIGE



BLU

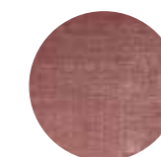

PINK

Pouf

Footool — Pouf — Otomana

Kubo

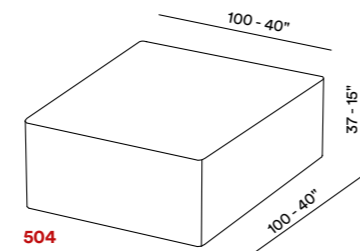
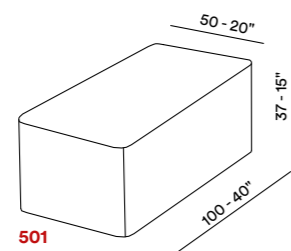
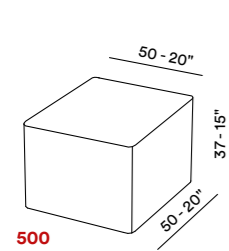

Roxy

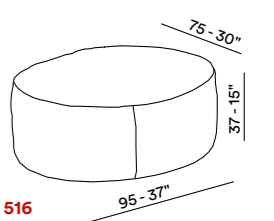
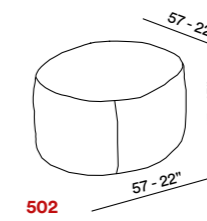
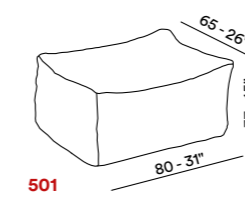
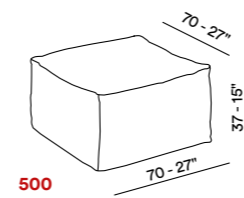

Tecnical Info

Abaco

→ 199

Finiture

Finishings — Finition — Acabados

→ 206

Descrizione struttura

Internal structure description — Description structure

— Escriptcion estructura

→ 207

Divani

Sofas — Canapé — Sofás

Asap

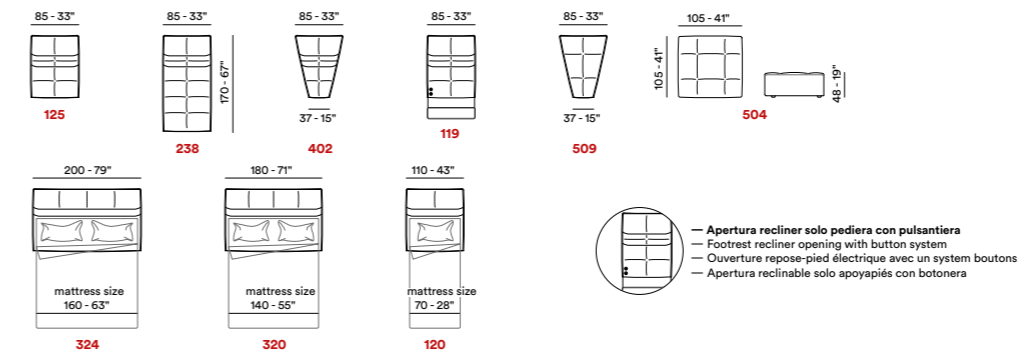

Esempi di componibilità — Sectionals examples — Exemples de compositions — Ejemplos de modularidad

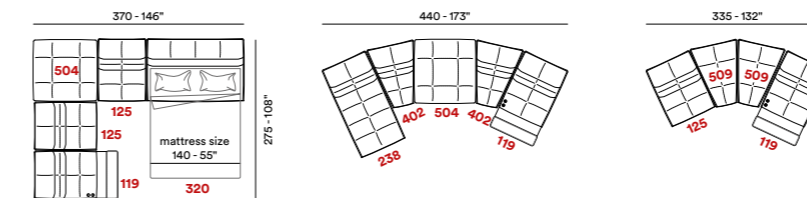

Bebe

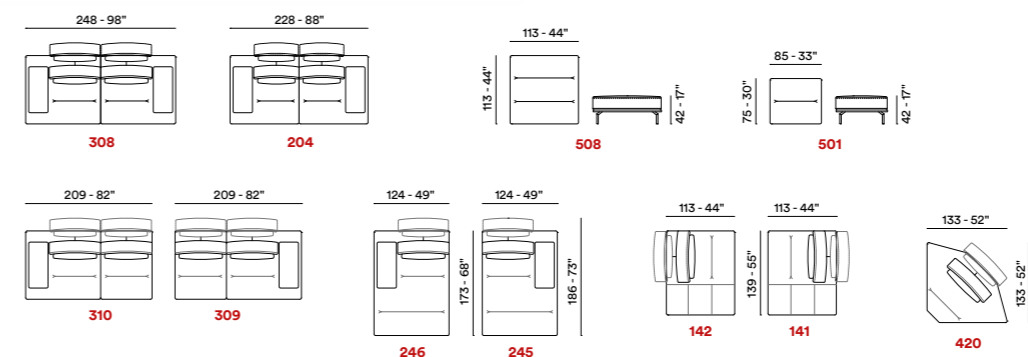

Esempi di componibilità — Sectionals examples — Exemples de compositions — Ejemplos de modularidad

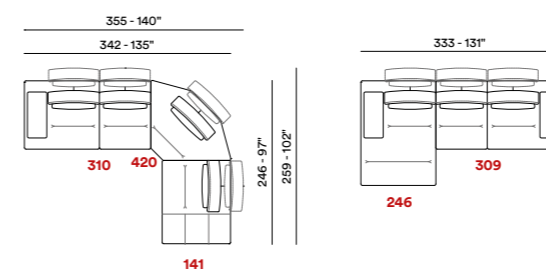

Bogart

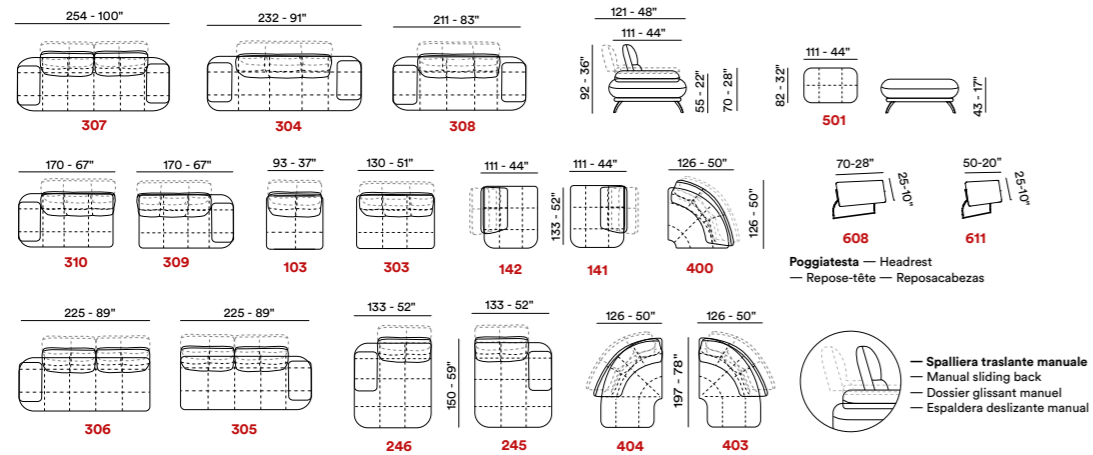

Esprit

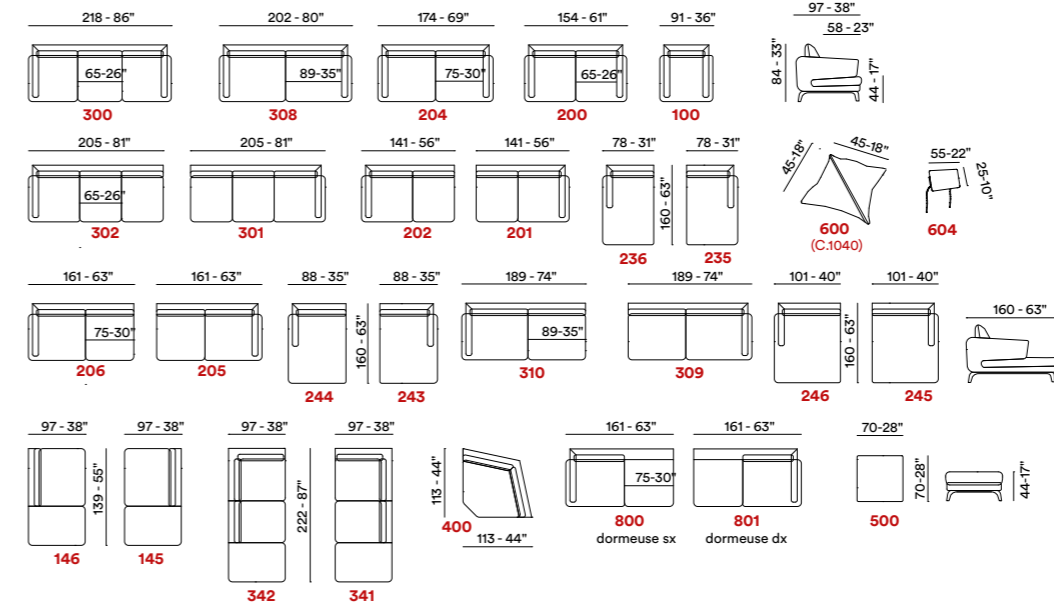

Cloud

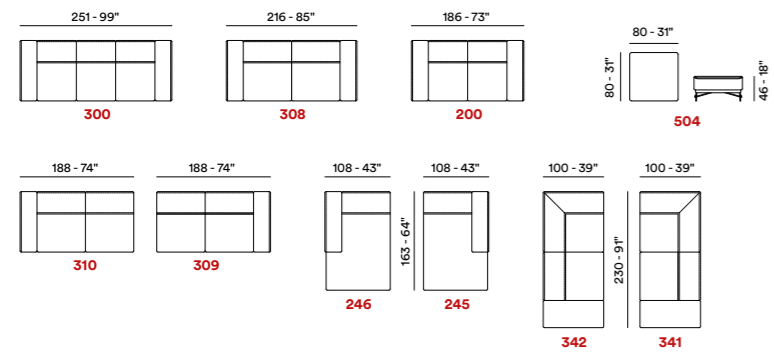

Flam

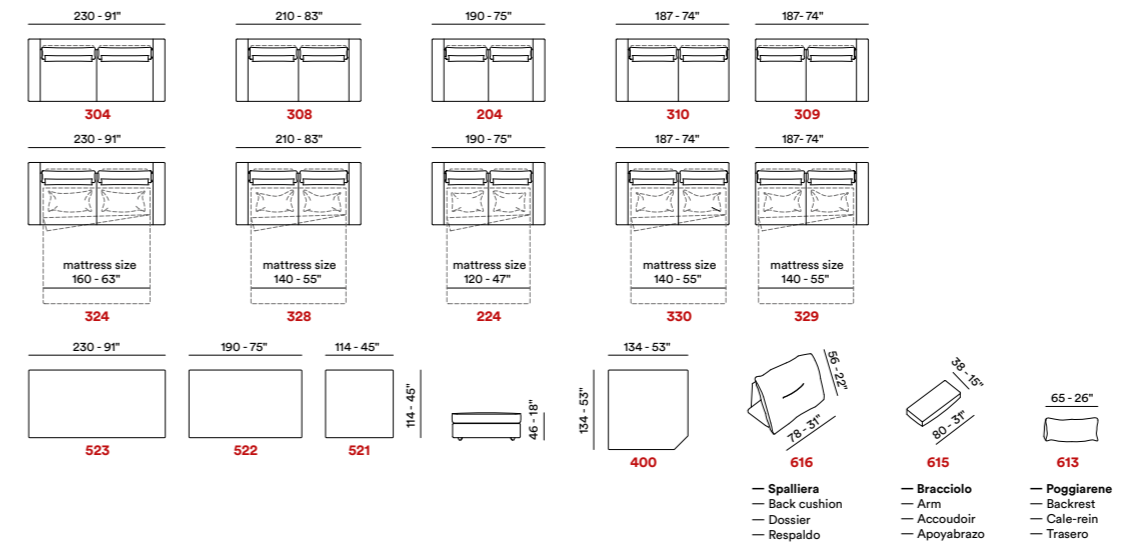

Kilt

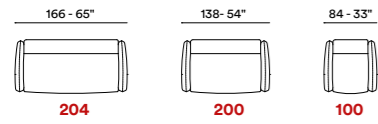

Noa

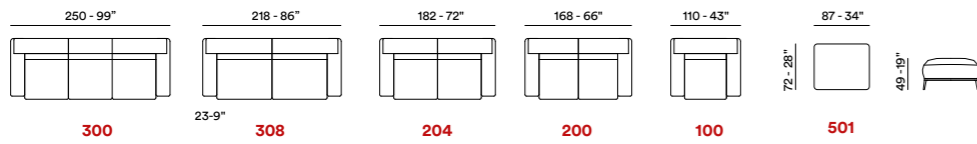

Quadro

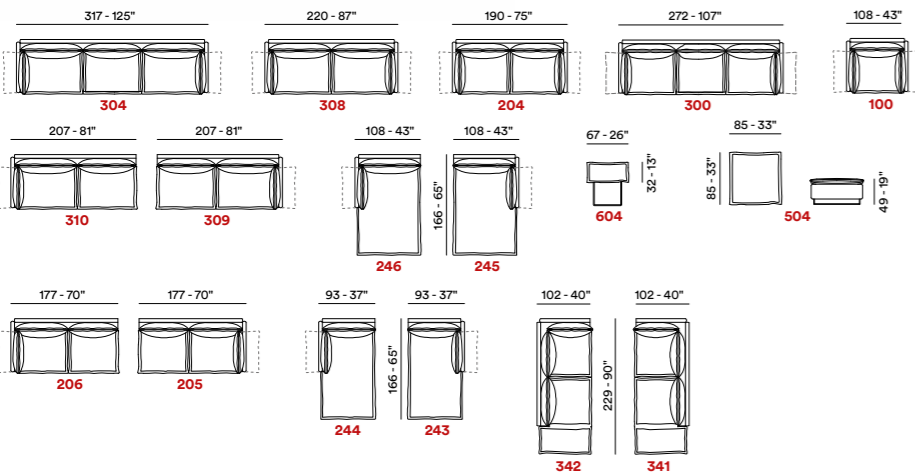

Raffaello

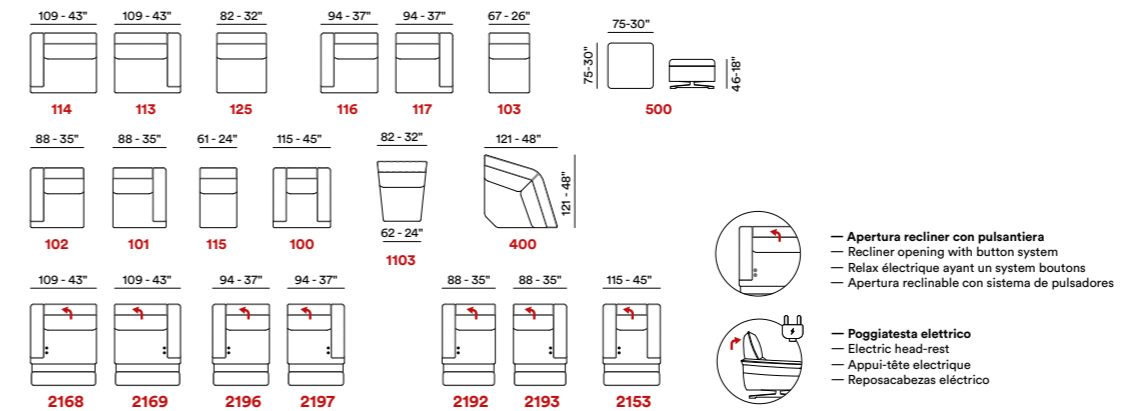

Riflesso

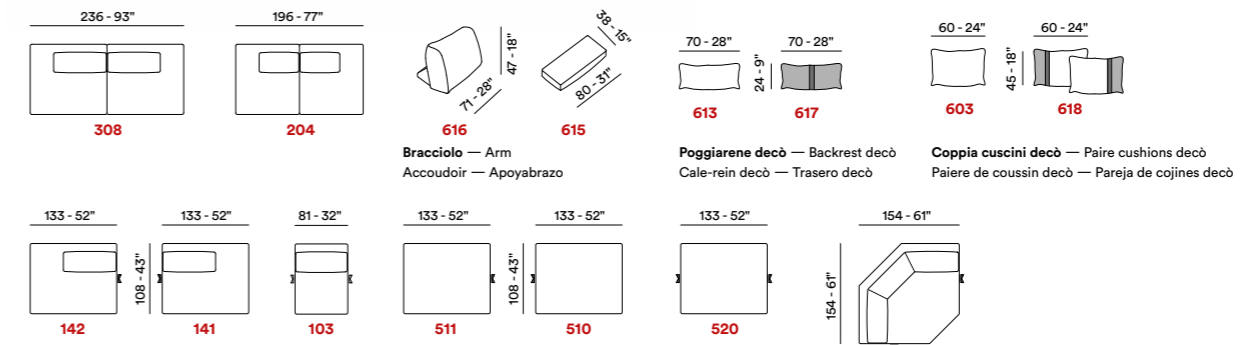

Tok

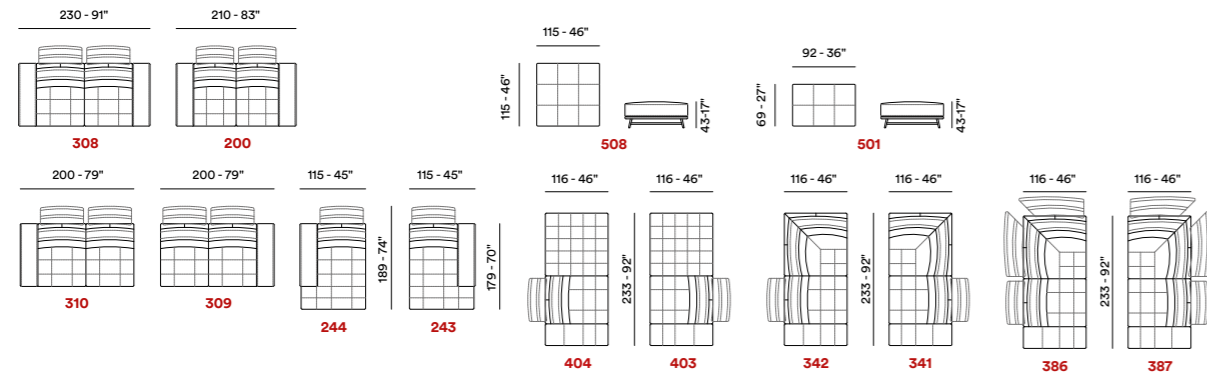

Poltrone

Armchairs — Fauteuils — Sillones

Blenda

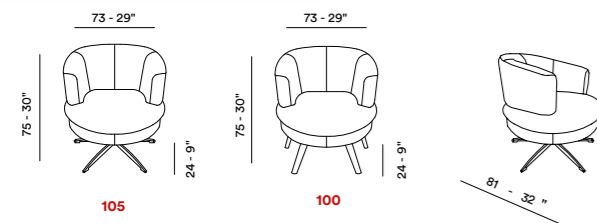

Regina

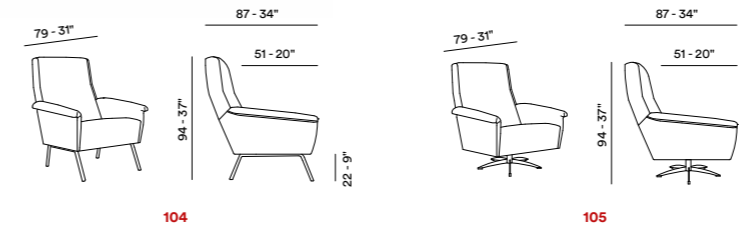

Dalia

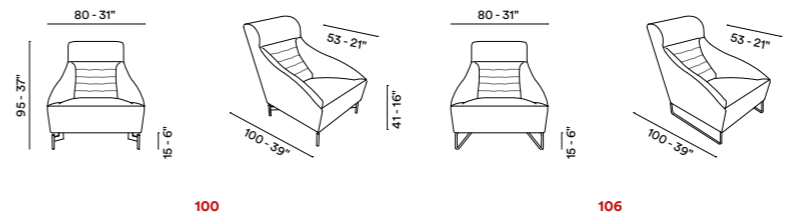

Doroty

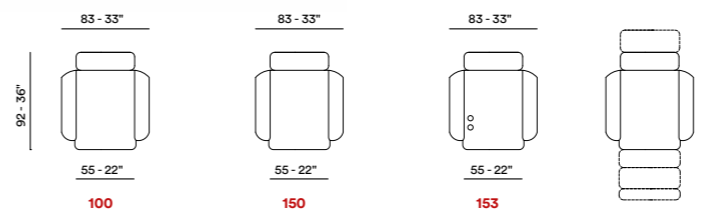

L'azienda si riserva di apportare alcune modifiche alle dimensioni. Le dimensioni sono soggette a leggere variazioni dovute alla manifattura. Some dimensions reported in this legend may be changed by the manufacturer. Such dimensions are subject to small discrepancy due to the handmade product. Les dimensions indiquées dans cette légende peuvent être modifiées par le fabricant. Les mêmes sont sujettes à de légères différences dues à la fabrication artisanale. La Empresa se reserva el derecho de hacer algunos cambios en las dimensiones. Las dimensiones están sujetas a ligeras variaciones debido a la fabricación.

Finiture

Finishings — Finition — Acabados

Metallo — Metal — Metal — Metal



10
Lucido
Chrome
Brillant
Brillante



11
Satinato
Brushed
Mat
Satinado



22
Bronzato
Bronze
Bronze
Bronce

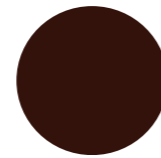

26
Marrone
Dark brown
Marron
Marrón

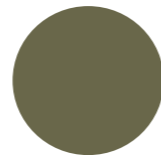

37
Mastice
Darke taupe
Mastic
Masilla



41
Ferro calamina
Calamine iron
Fer calamine
Hierro calamina

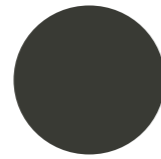

42
Grigio scuro
Dark grey
Gris foncé
Gris oscuro

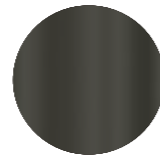

46
Titanio
Titanium
Titane
Titanio

Legno — Wood — Bois — Madera



01
Naturale
Natural
Naturel
Naturales



02
Ciliegio
Cherry
Merisier
Cerezo

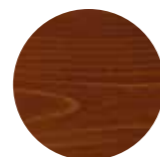

03
Noce
Walnut
Noyer
Nuez



04
Noce brunito
Dark walnut
Noyer foncé
Nogal dorado



06
Wengé
Wengé
Wengé
Wengé



09
Alluminio
Alluminium
Aluminium
Aluminio



12
Sbiancato
White washed
Céruse
Blanqueado

— I riferimenti dei colori qui riportati sono da considerarsi puramente indicativi.
— Color reference shown is only indicative.
— La référence coloris mentionnée est purement indicative.
— Las referencias de color que se muestran aquí deben considerarse puramente indicativas.

Descrizione struttura

Internal structure description — Description structure — Escriptcion estructura



ITA — Struttura in legno

La struttura portante è realizzata in legno massello di abete a vari spessori. Per le parti non strutturali si utilizzano pannelli di particelle di legno e pannelli di fibra di legno fini e uniformi legate con resine.

Struttura in legno e metallo

La struttura portante è realizzata in legno massello e profili di metallo a differenti sezioni. Per le parti non strutturali si utilizzano pannelli di particelle di legno e pannelli di fibra di legno fini e uniformi legate con resine.

Struttura in metallo

La struttura portante è realizzata con telaio in ferro a differenti sezioni. Per le parti non strutturali e di tamponamento si utilizzano reti elettrosaldate a differenti maglie.

ENG — Wooden structure

The supporting structure is made of solid fir wood of various thicknesses, for the non-structural parts are used panels of wood's particles and also fine and uniform wood fiber panels bonded with resins.

Wood and metal structure

The supporting structure is made of solid wood and metal profiles with different sections, for the non-structural parts are used panels of wood's particles and also fine and uniform wood fiber panels bonded with resins.

Metal structure

The supporting structure is made of an iron frame with different sections, for the non-structural parts and infill parts are used electrowelded with different meshes.

FR — Structure en bois

La structure de support est faite de bois de sapin massif de diverses épaisseurs. Pour les parties non structurelles on utilise des panneaux de particules de bois et des panneaux de fibres de bois fins et uniformes liés avec des résines.

Bois et structure métallique

La structure de support est composée de profilés en bois massif et en métal avec différentes sections. Pour les parties non structurelles on utilise des panneaux de particules de bois et des panneaux de fibres de bois fins et uniformes collés avec des résines.

Structure métallique

La structure de support est faite d'un cadre de fer avec différentes sections. Pour les parties non structurelles et de remplissage on utilise des mailles électrosoudées.

ES — Estructura de madera

La estructura de soporte está hecha de madera de abeto macizo de varios espesores, para las partes no estructurales se utilizan paneles de partículas de madera y paneles de fibra de madera finos y uniformes unidos con resinas.

Estructura de madera y metal

La estructura de soporte está hecha de madera maciza y perfiles metálicos con diferentes secciones, para las partes no estructurales se utilizan paneles de partículas de madera y paneles de fibra de madera finos y uniformes unidos con resinas.

Estructura de metal

La estructura de soporte está hecha de un marco de hierro con diferentes secciones, para las partes no estructurales y de relleno se utilizan mallas electrosoldadas con diferentes mallas.

**Maxdivani S.r.l.**

Largo Epitaffio, 1
70022 Altamura (Ba)
Tel. +39 080 926 6200
info@maxdivani.it
maxdivani.it

Art Direction

—

Arch. Giuseppe Logrieco / Maxdivani mktg. dept.

Graphic Design

—

Leonardi and Partners

Photo

—

Leon Foto / Stragapede

Color Selections

—

Color Lab

Print

—

Stampa Sud S.p.A.

Stampato in Italia - Marzo 2020

Printed in Italy - March 2020

La MAXDIVANI s.r.l. si riserva la facoltà di modificare in qualunque momento e senza preavviso, le caratteristiche tecniche degli elementi usati nel presente catalogo. Le misure riportate nei grafici possono subire variazioni dovute alla manifattura. Alcuni accessori presenti nelle immagini fotografiche non sono prodotti dalla MAXDIVANI s.r.l.. Il presente catalogo è tutelato dalla legge sui diritti d'Autore (legge 22.4.1941, n° 633 e della legge 14.12.1942, n° 1485); e successive modifiche, di esso è proibita ogni riproduzione, totale o anche parziale in Italia o all'estero.

MAXDIVANI s.r.l. reserves the right to modify in any moment and without notice the technical characteristics of the elements used in this catalogue. Some dimensions reported in the schematics may be subject to modifications due to manufacturing. Some of the accessories shown in the pictures are not produced by MAXDIVANI s.r.l.. This catalogue is protected by the law on Author's Rights (law dated 22.04.1941, no. 633 and by the law dated 14.12.1942, no. 1485); and its following modifications. Any reproduction, complete or in part, is forbidden in Italy and abroad.

MAXDIVANI s.r.l. se réserve le droit de modifier à tout moment et sans préavis les caractéristiques techniques des éléments utilisés dans ce catalogue. Les mesures montrées dans les graphiques peuvent subir des variations dues à la fabrication. Certains accessoires présents dans les images photographiques ne sont pas produits par MAXDIVANI srl Ce catalogue est protégé par la loi sur les droits d'auteur (loi 22.4.1941, loi n° 633 et loi 14.12.1942, n° 1485); telle que modifiée, Il est interdit toute reproduction, totale ou même partielle en Italie ou à l'étranger.

El MAXDIVANI s.r.l. se reserva el derecho de modificar en cualquier momento y sin previo aviso las características técnicas de los elementos utilizados en este catálogo. Las medidas que se muestran en los gráficos pueden sufrir variaciones debido a la fabricación. Algunos accesorios presentes en las imágenes fotográficas no son producidos por MAXDIVANI s.r.l. Este catálogo está protegido por la ley de derechos de autor (ley 22.4.1941, n° 633 y ley 14.12.1942, n° 1485); está prohibido cualquier reproducción, total o parcial en Italia o en el extranjero.



maxdivani.it



Maxdivani s.r.l. - Largo Epitaffio, 1 - 70022 Altamura (Ba) Italy - Tel +39 080 9266200 - info@maxdivani.it